

APRIL · 1947

electronics

A MCGRAW-HILL PUBLICATION

Steve Sulik

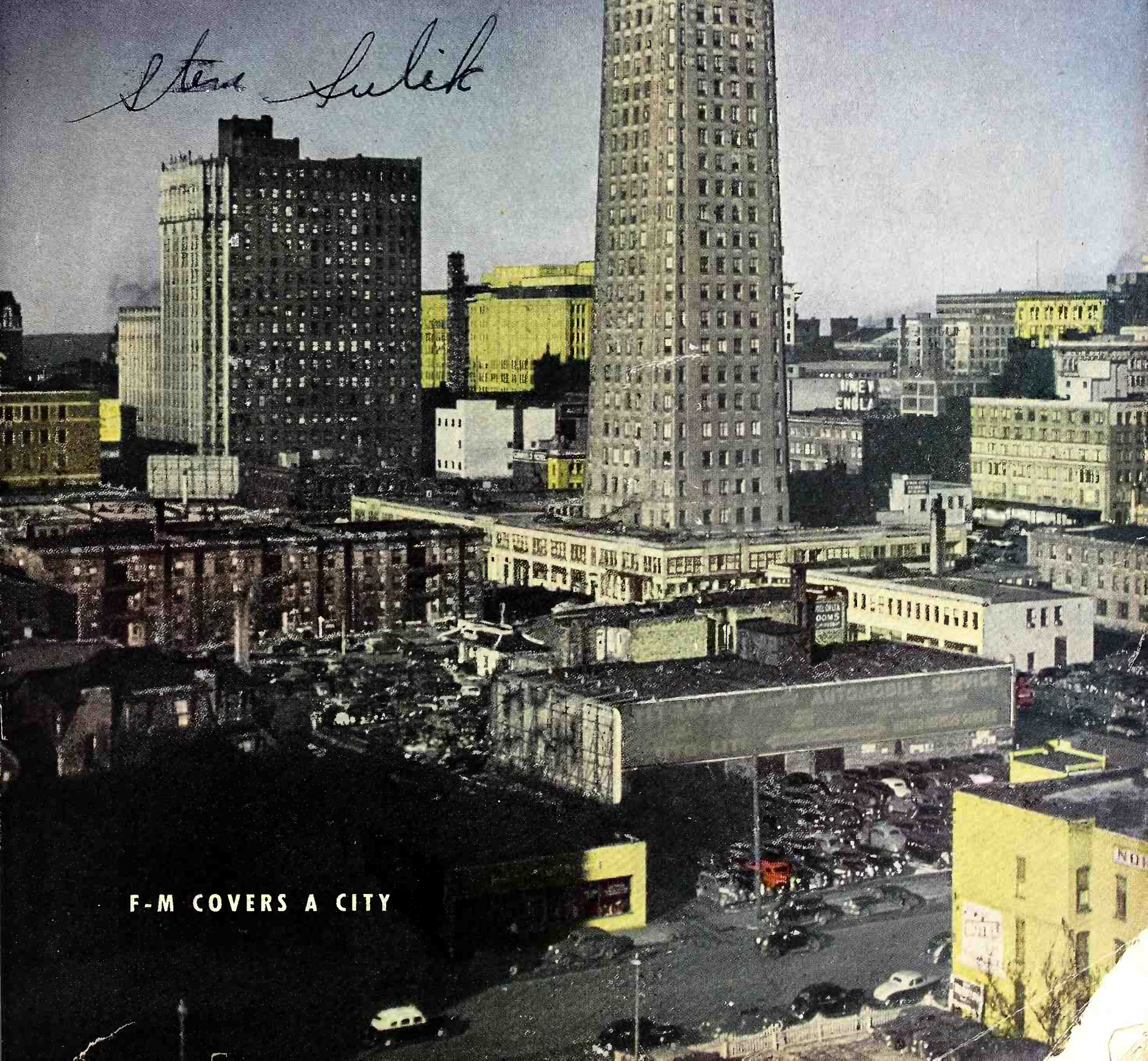

F-M COVERS A CITY



**THESE AND
A HUNDRED OTHERS**

**COMMUNICATION
INDUSTRIAL
RECTIFICATION
ELECTRO-MEDICAL
EXPERIMENTAL
SPECIAL PURPOSE**

**ONE SOURCE FOR ALL TYPES
AMPEREX**

For a quarter century AMPEREX has been identified with creative research, laboratory approach, precision manufacture and helpful service in its chosen field—power tubes. As tube specialists deeply concerned with all modern developments, Amperex engineers are in a position to give detached counsel and information.

WRITE, AMPEREX APPLICATION ENGINEERING DEPARTMENT
AMPEREX ELECTRONIC CORPORATION

25 WASHINGTON STREET, BROOKLYN 1, NEW YORK
IN CANADA AND NEWFOUNDLAND: ROGERS MAJESTIC LIMITED
11-19 BRENTCLIFFE RD., LEASIDE, TORONTO 12, ONTARIO, CANADA

electronics



APRIL • 1947

F-M COVERS A CITY			Cover
Federal eight-bay square-loop antenna of WTCN-FM, on the Foshay Tower in Minneapolis. Details on p 166, ELECTRONICS, March 1947			
THE TELEVISION ANTENNA PROBLEM			88
Thorough analysis of master antenna systems for apartment houses is needed			
EXPERIMENTS IN LISTENING, by Norman D. Webster and Franklin C. McPeak			90
Audience reaction to reproduced music is tested with a stereophonic audio system			
PHOTOELECTRIC TRANSMITTING TYPEWRITER, by George Bush			96
Light beams are interrupted by shutters attached to keys of standard machine			
COMPACT ELECTRO-MECHANICAL FILTER, by Robert Adler			100
Vibrating steel plates used as i-f filters in receiver give high selectivity			
IMPEDANCE BRIDGE FOR FLOW-RATE METERING, by Fred J. Curran			106
A float moves an armature in a balancing circuit that drives a reversible motor			
HELICAL BEAM ANTENNA, by John D. Kraus			109
Axial mode radiation provides circular polarization, with readily controlled directivity and gain			
METALLIZED CAPACITOR TESTS, by Philip Godley and Jayson C. Balsbaugh			112
Methods of determining effect of arc-overs, dielectric constant, and power factor			
COMPARATOR FOR COAXIAL LINE ADJUSTMENT, by O. M. Woodward, Jr.			116
A simple, compact device for matching transmission lines to antenna arrays or other adjustable loads			
CATHODE-RAY COMPASS, by Ralph T. Squier			121
Autopilot of a plane controls directional flight exactly when errors in the slave gyro are corrected			
TELEMETERING FROM ROCKETS, by V. L. Heeren, C. H. Hoepfner, J. R. Kauke, S. W. Lichtman, P. R. Shiffett			124
Circuit used for decoding time-modulated pulse sequences, translating to voltages, recording			
ELECTRONIC SWITCH FOR THE PRODUCTION OF PULSES, by C. R. Smitley and R. E. Graber			128
Independent control of pulse length, pulse rate, and other signal characteristics is provided			
R-C BANDPASS FILTER DESIGN, by Jack L. Bowers			131
Description of a filter that is smaller and better at low frequencies than an L-C type			
SHF HETERODYNE FREQUENCY METER, by Carson D. Jeffries			134
A highly accurate portable meter for use from 450 to 10,000 megacycles			
WIDE-BAND I-F AMPLIFIERS ABOVE 100 MC, by Matthew T. Lebenbaum			138
Consideration of necessary compensation for staggered couplings at vhf			
REVERBERATION TIME NOMOGRAPHS, by R. C. Coile			142
Two nomographs give reverberation time in seconds if volume of room and area of each material are known			
BUSINESS BRIEFS	82	INDUSTRIAL CONTROL	150
CROSSTALK	87	ELECTRON ART	152
TUBES AT WORK	146	NEW PRODUCTS	156
		NEWS OF THE INDUSTRY	162
		NEW BOOKS	280
		BACKTALK	282
		INDEX TO ADVERTISERS	291

DONALD G. FINK, Editor; **KEITH HENNEY**, Consulting Editor; **W. W. MacDonald**, Managing Editor; **John Markus**, **Vin Zeluff**, Associate Editors; **Frank Rockett**, **A. A. McKenzie**, Assistant Editors; **Gladys T. Montgomery**, Washington Editor; **William P. O'Brien**, Make-up Editor; **Harry Phillips**, Art Director; **Eleanore Luke**, Art Assistant

H. W. MATEER, Publisher; **WALLACE B. BLOOD**, Manager; **J. E. Blackburn, Jr.**, Director of Circulation; **Dexter Keezer**, Director, Economics Department; **John Chapman**, World News Director; **D. H. Miller**, **H. R. Denmead, Jr.**, New York; **Wm. S. Hodgkinson**, New England; **F. P. Coyle**, **R. E. Miller**, Philadelphia; **C. D. Wardner**, Chicago; **E. J. Smith**, Cleveland; **J. W. Otterson**, San Francisco; **Roy N. Phelan**, Los Angeles; **Ralph C. Maultsby**, Atlanta; **Paul West**, London, England

Contents Copyright, 1947, by McGraw-Hill Publishing Company, Inc. All Rights Reserved. McGRAW-HILL PUBLISHING COMPANY INCORPORATED, JAMES H. MCGRAW, Founder and Honorary Chairman • PUBLICATION OFFICE 99-129 North Broadway, Albany 1, N. Y., U. S. A. EDITORIAL AND EXECUTIVE OFFICES 330 West 42nd St., New York 18, N. Y., U. S. A. —Member A. B. P. Member A. B. C.

James H. McGraw, Jr., President; Curtis W. McGraw, Senior Vice-President and Treasurer; Nelson Bond, Director of Advertising; Eugene Duffield, Editorial Assistant to the President; Joseph A. Gerardi, Secretary; and J. E. Blackburn, Jr., Vice-President for circulation operations.
ELECTRONICS, April, 1947, Vol. 20; No. 4. Published monthly, with an additional issue in June, price 75c a copy. Directory Issue \$2.00. Allow at least ten days for change of address. All communications about subscriptions should be addressed to the Director of Circulation.
Subscription rates—United States and possessions, \$6.00 a year, \$9.00 for two years, \$12.00 for three years. Canada (Canadian funds accepted) \$7.00 a year, \$11.00 for two years, \$14.00 for three years. Pan American countries \$10.00 for one year, \$16.00 for two years, \$20.00 for three years. All other countries \$15.00 for one year, \$30.00 for three years. Please indicate position and company connection on all subscription orders. Entered as Second Class matter August 29, 1936, at Post Office, Albany, New York, under the Act of March 3, 1879. BRANCH OFFICES: 520 North Michigan Avenue, Chicago 11, Ill.; 68 Post Street, San Francisco 4; Aldwych House, Aldwych, London, W.C. 2; Washington, D. C. 4; Philadelphia 3; Cleveland 15; Detroit 26; St. Louis 8; Boston 16; Atlanta 3, Ga.; 621 So. Hope St., Los Angeles 14; 738-9 Oliver Building, Pittsburgh 22.

Now available from Tobe...

Electrolytic MOTOR-STARTING CAPACITORS



Suitable for use in starting circuits of a-c motors within their nominal voltage rating and at all temperatures from -76°F to $+185^{\circ}\text{F}$.

These units are supplied without insulating tube or other hardware. Requests for hardware should be accompanied by drawings of parts required.

110 VOLTS -- A-C			110 VOLTS -- A-C		
Capacitance	Case		Capacitance	Case	
Min. - Max.			Min. - Max.		
20 - 24	A		216 - 240	B	
27 - 30	A		243 - 270	B	
32 - 36	A		270 - 300	B	
43 - 48	A		324 - 360	C	
54 - 60	A		378 - 420	C	
64 - 71	A				
70 - 78	A		220 VOLTS -- A-C		
76 - 84	A		20 - 24	A	
86 - 96	A		26 - 30	A	
97 - 107	A		32 - 36	C	
108 - 120	A		38 - 42	C	
124 - 138	A		43 - 48	C	
145 - 161	B		53 - 60	C	
162 - 180	B				
189 - 210	B				

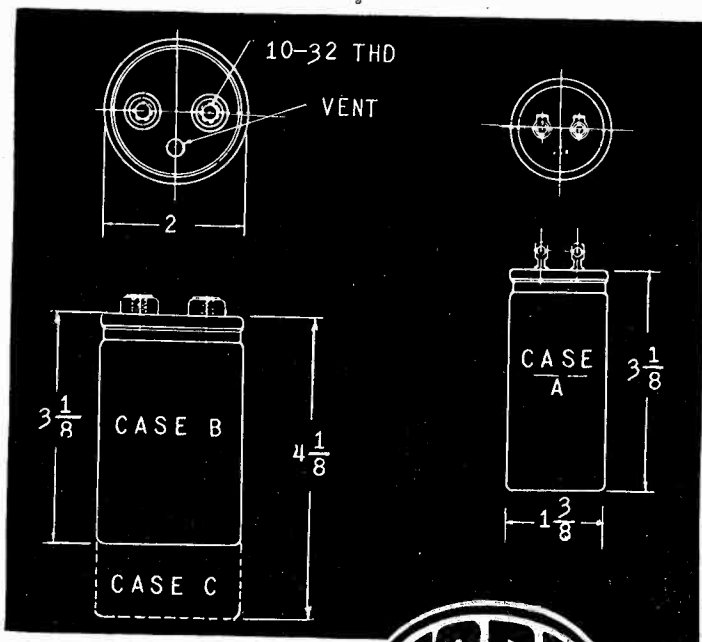

TOBE DEUTSCHMANN Corporation CANTON, MASSACHUSETTS



...the world's highest dams



...longest bridges

• As the draftsman's pencil makes its mark, he issues orders, through a remarkable kind of shorthand, to the men who must act on his drawings. But only with special assistance can human hands shape such precise, complex orders as these. No wonder the draftsman chooses his instruments with care . . . he is, in effect, taking them into partnership!

In this sense, Keuffel & Esser Co. drafting equipment and materials have been the draftsman's partners for 80 years in creating the peaceful culture and wartime might of America, in making possible our concrete dams, steel bridges, aluminum bombers.

So universally is this equipment used, it is self-evident that every engineering project of any magnitude has been built with the help of K & E. Could you wish surer guidance than this in the selection of your "drafting partners"?

Especially in these hurried days, you will find a PARAGON* Drafting Machine a boon to your work . . . and your nerves! With the finger tips of your left hand on its control ring, the lightest pressure enables you to set the scales at any angle, anywhere on the board. Your right hand is always free. For the full PARAGON* story, write on your letterhead to Keuffel & Esser Co., Hoboken, N. J.

**Reg. U. S. Pat. Off.*

partners in creating



Drafting, Reproduction,
Surveying Equipment
and Materials.
Slide Rules,
Measuring Tapes.

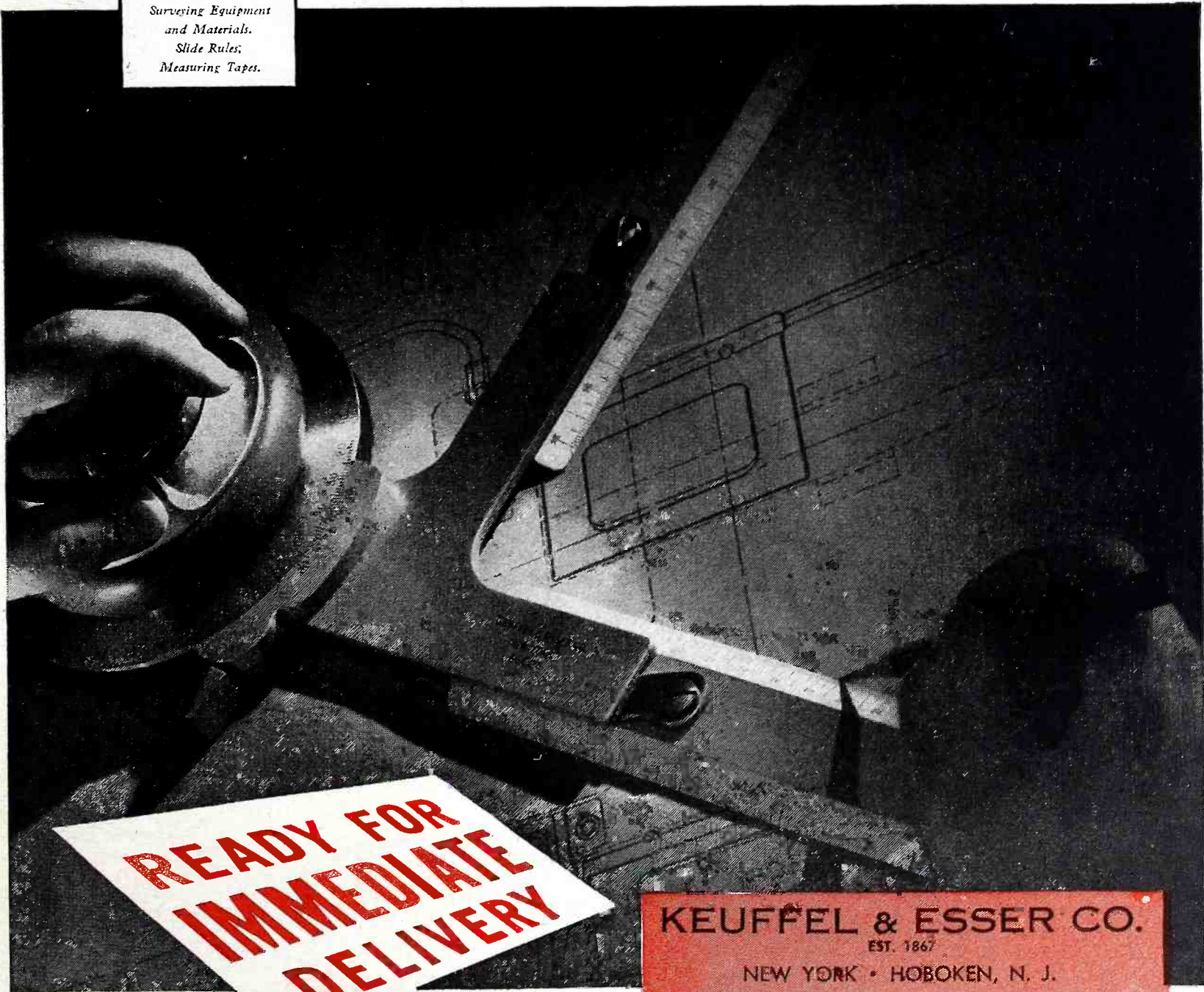

KEUFFEL & ESSER CO.

EST. 1867

NEW YORK • HOBOKEN, N. J.

CHICAGO • ST. LOUIS • DETROIT • SAN FRANCISCO

LOS ANGELES • MONTREAL

**YOU BUY
PERFORMANCE
IN THE
HQ-129-X**

Pull the weak ones out of the QRM—Tune in a "ZL" and hold on to him—Turn on the noise limiter and really kill ignition noise—That is what thousands of hams are doing every day with the HQ-129-X

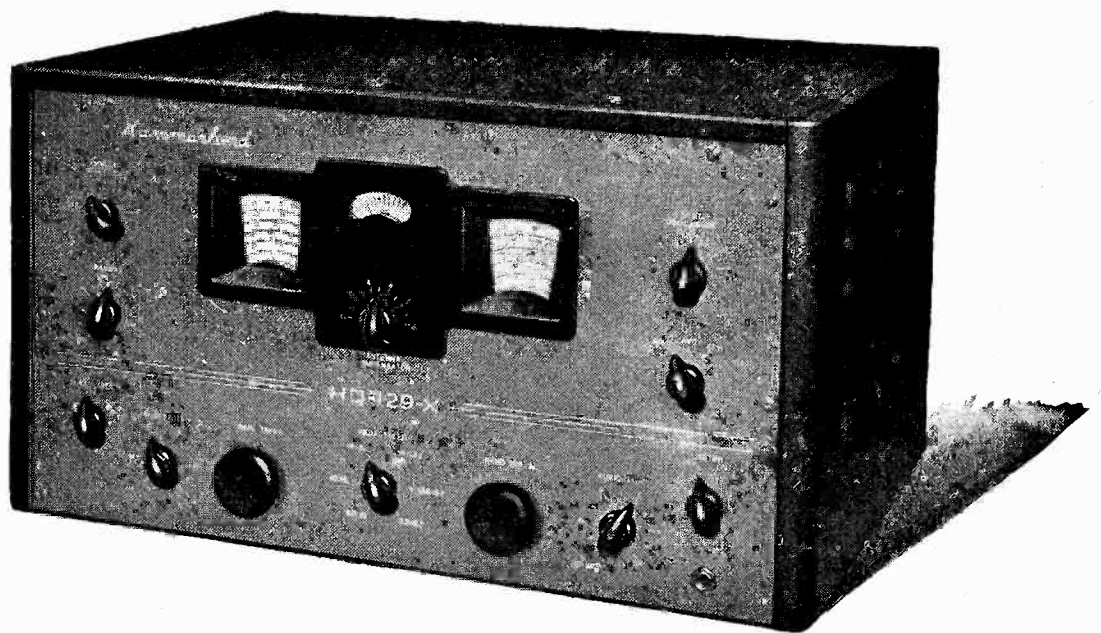

36
BACKED BY

YEARS OF KNOW HOW

see
the HQ-129-X
at your dealer's



HAMMARLUND

THE HAMMARLUND MFG. CO., INC., 460 W. 34TH ST., NEW YORK 1, N.Y.
MANUFACTURERS OF PRECISION COMMUNICATIONS EQUIPMENT



A-C CAPACITORS

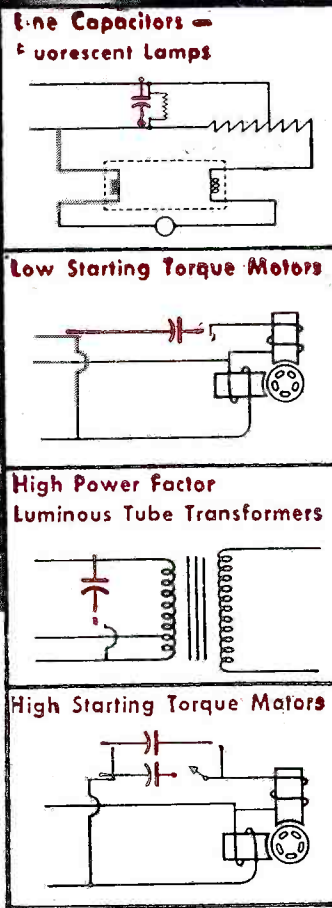
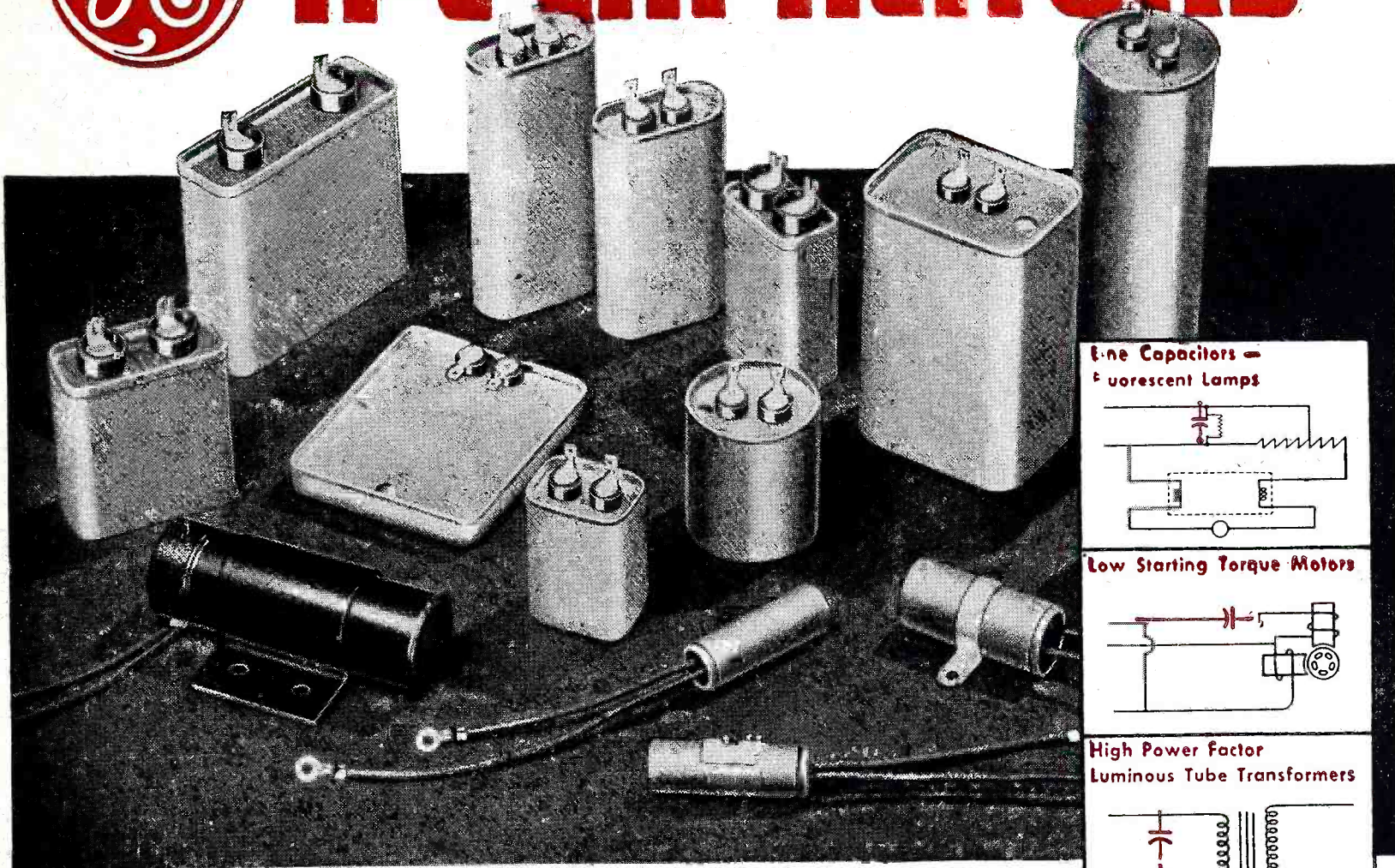

THEIR STRENGTH ADDS "STAYING POWER" TO YOUR PRODUCTS

Capacitors needn't be the weak link in your product—they can have just as much "staying power" as any other component in your equipment.

G-E capacitors have long life. One reason for this is that they are Pyranol* impregnated. Practically all moisture, air, and gas have been withdrawn from the capacitor before the Pyranol treatment takes place. The use of Pyranol also means that these capacitors can operate at high temperatures—up to 75 C (167 F) case temperature. This eliminates one of the main causes of capacitor breakdown.

Casings, available in all standard shapes, are double-rolled, or roll-crimped and soldered, sealing the capacitor hermetically. Plastic bushings, of high dielectric strength, bring out the hot-tin dipped soldered terminals.

If you are building a quality product, here's a quality a-c capacitor that you'll never have to worry about. They're available in a broad range of voltage ratings and capacities. Write for the latest Bulletin GEA-2027C. Apparatus Dept., General Electric, Schenectady 5, N. Y.

*Reg. U. S. Pat. Off.

Why Manufacturers Like G-E Capacitors

1. Their price is right.
2. You can get fast shipments.
3. The range of ratings is broad.
4. Designed for small size and light weight in all ratings.
5. Their quality is unexcelled.

GENERAL ELECTRIC

407-111-5700

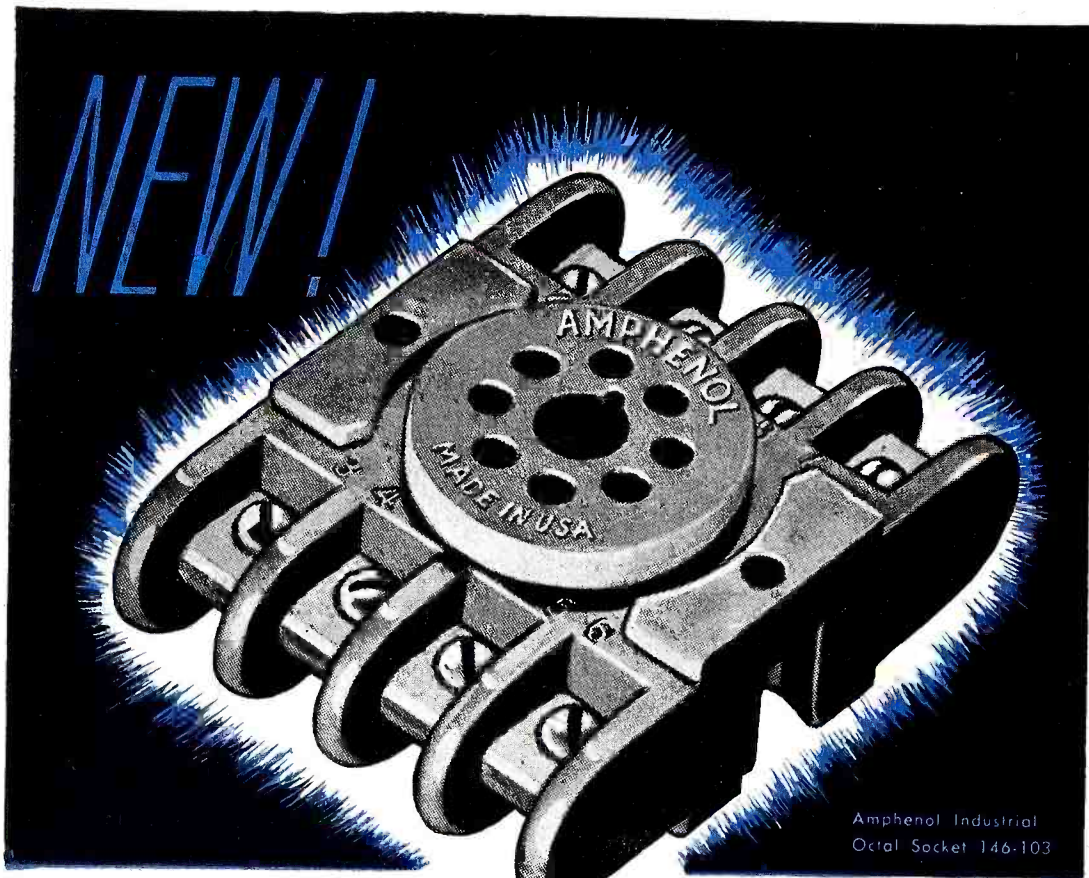

- ★ First to comply with N.E.M.A. and Underwriters' specifications for industrial equipment.
- ★ Rugged insulating barriers prevent flashover and arcing in humid and dusty industrial applications.
- ★ Reversible binding screw terminals simplify wiring and maintenance.
- ★ Cloverleaf contacts . . . four full length lines of contact with each tube pin.

AMPHENOL ELECTRONIC TUBE SOCKETS

designed for INDUSTRIAL applications

Amphenol Electronic Tube Sockets are specially designed for industrial applications. Ruggedly built for utmost dependability and peak performance, they were the first industrial tube sockets to comply with N.E.M.A. and Underwriters' specifications for industrial equipment.

Amphenol sockets are molded of melamine resin or bakelite for strength as well as high arc-resistance and reduced carbon tracking. Utilization of the latest developments in spring bronze has insured the highest degree of contact conductivity and long spring life. Maximum spacing between contacts and chassis is maintained. Heavy insulating barriers prevent flashover between contacts under the adverse conditions found in industrial usage. Screw type terminals provide for quick connect and disconnect, ideal for testing and replacement. No soldering is required.

Amphenol sockets are available in types for practically all industrial electronic tubes. Write today for complete information.



AMERICAN PHENOLIC CORPORATION
1830 SOUTH FIFTY-FOURTH AVENUE
CHICAGO 50, ILLINOIS

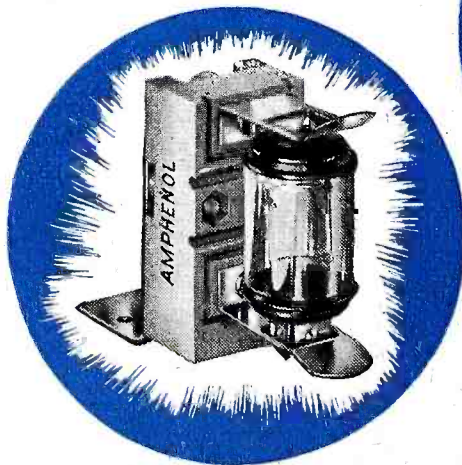
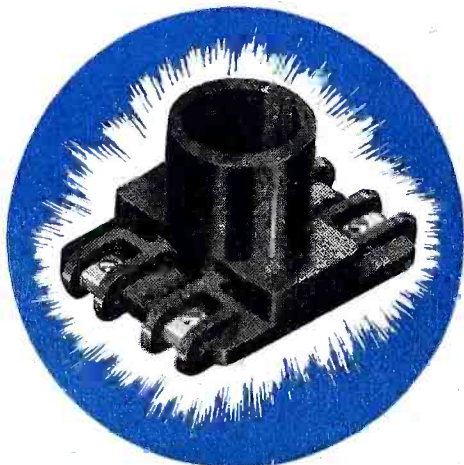
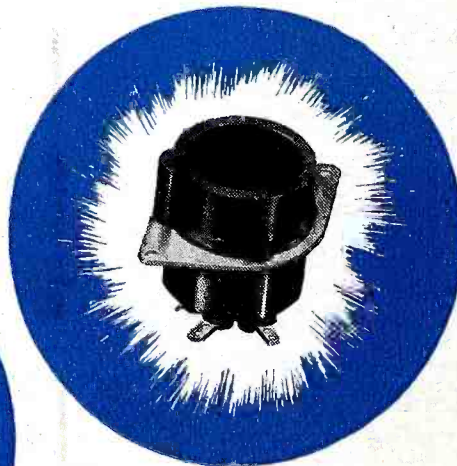

A few of Amphenol's complete line of industrial tube sockets are illustrated

NOW! a new standard of performance in cutting heads

THE PRESTO 1-D

► The new Presto 1-D Cutting Head offers: *wide range, low distortion, high sensitivity and stability through a temperature range of 60°-95° F.* The Presto 1-D Cutting Head is a precision instrument made entirely of precisely machined parts, expertly assembled and carefully calibrated. These factors, plus its sound basic engineering design, produce a cutter unequaled in performance by any other mechanically damped magnetic device.

► Note from the light pattern below: The correct location of the cross-over point at 500 cycles, the 6 db per octave slope below this point, and flat response above 500 cycles, which is free from resonant peaks. The range of the cutter is 50-10,000 cycles. The Presto 1-D is damped with "Prestoflex" which is impervious to temperature changes between 60 and 95 degrees Fahrenheit.

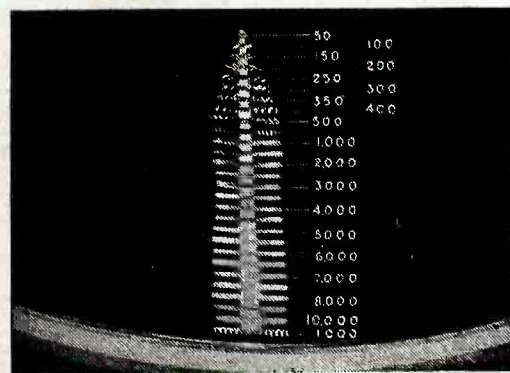
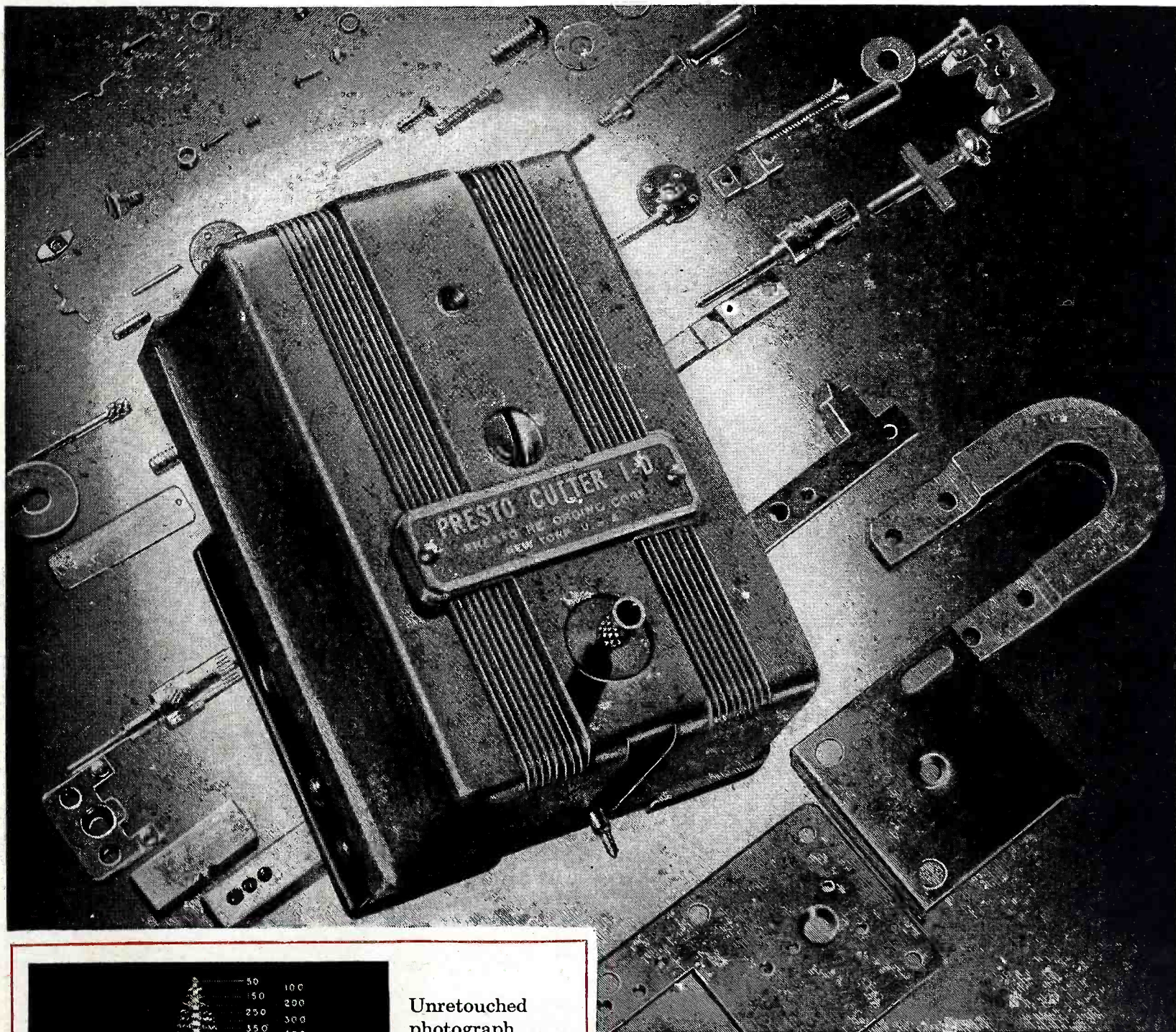

Unretouched photograph showing the light pattern. Notice correct location of the cross-over point at 500 cycles.

PRESTO

RECORDING CORPORATION
242 WEST 55TH STREET, NEW YORK 19, N. Y.
Walter P. Downs, Ltd., in Canada

WORLD'S LARGEST MANUFACTURER OF INSTANTANEOUS SOUND RECORDING EQUIPMENT & DISCS

**the one dependable source of supply
for everything in electrical insulation**

MITCHELL RAND

VARNISHES

VARNISHED TUBINGS, SLEEVINGS and TAPES

COTTON TAPES and SLEEVINGS

FIBERGLAS TUBINGS, SLEEVINGS and TAPES

FIBERGLAS-MICA COMBINATIONS

WAXES · COMPOUNDS · ETC.

**M - R THE
ELECTRICAL
INSULATION
HEADQUARTERS
FOR 58 YEARS.**



MITCHELL-RAND INSULATION CO. Inc.

51 MURRAY STREET · Cortlandt 7-9264 · NEW YORK 7, N. Y.

A PARTIAL LIST OF M-R PRODUCTS: FIBERGLAS VARNISHED TUBING, TAPE AND CLOTH · INSULATING PAPERS AND TWINES · CABLE FILLING AND POHEAD COMPOUNDS · FRICTION TAPE AND SPLICE · TRANSFORMER COMPOUNDS · FIBERGLAS SATURATED SLEEVING · ASBESTOS SLEEVING AND TAPE · VARNISHED CAMBRIC CLOTH AND TAPE · MICA PLATE, TAPE, PAPER, CLOTH, TUBING · FIBERGLAS BRAIDED SLEEVING · COTTON TAPES, WEBBINGS AND SLEEVINGS · IMPREGNATED VARNISH TUBING · INSULATED VARNISHES OF ALL TYPES · EXTRUDED PLASTIC TUBING

MANY FEATURES IN ONE INSTRUMENT!

The **Q-METER**

TYPE 160-A

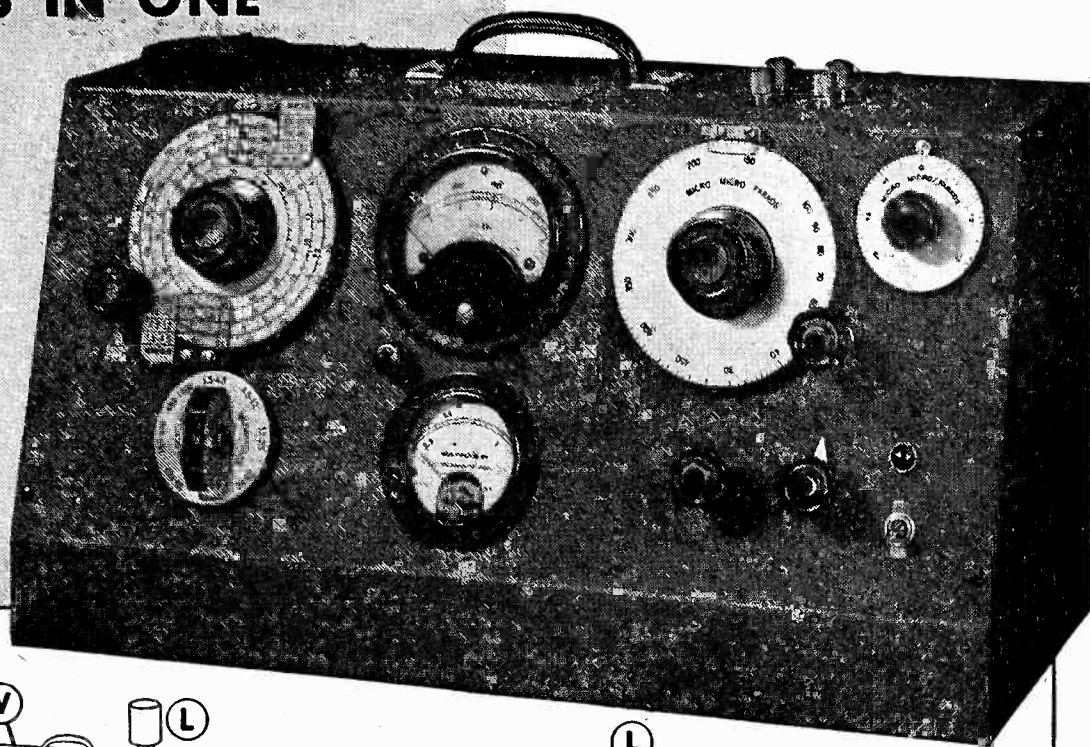

A dependable test and measuring instrument that should be included in your new equipment plans.

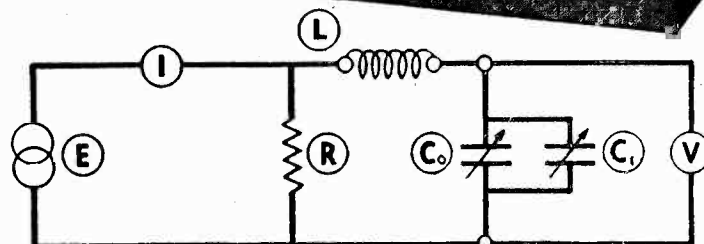
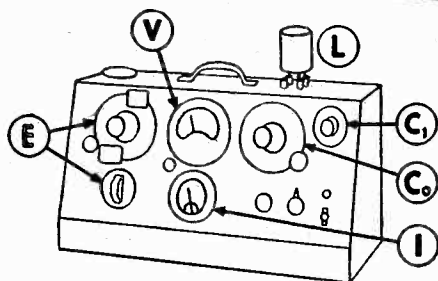

SIMPLIFIED LAYOUT AND SCHEMATIC OF THE 160-A Q-METER

For many years the Q-Meter has been an outstanding contribution to the field of radio frequency measuring equipment. It is an indispensable instrument to engineers, manufacturers, research laboratories and to the whole radio and electronics industry. Because of its simplicity and ease of operation, it replaces many costly pieces of apparatus with which the radio laboratory is customarily equipped. More than one radio engineer has told us that "The Q-Meter is the most valuable instrument that we have in our laboratory".

A FEW USES OF THE 160-A-Q-METER

- Q and inductance measurement of coils.
- Q and capacitance measurement of capacitors.
- Dielectric and power factor measurements of ceramics, plastics and other insulating materials.
- Measurement of circuit losses.
- Interelectrode capacitance measurements.
- Measurement of input impedance of vacuum tubes.
- Measurement of high frequency cable characteristics.
- Measurement of characteristics of small antennae.
- Measurement of coefficient of coupling of R.F. Transformers.
- Measurement of transmission line characteristics.
- The measurement of frequency with negligible loading on circuit under test (50 kc.—75 mc.).

Write for catalog and supplement.

BOONTON RADIO
BOONTON · N · J · U · S · A · *Corporation*

THE BASIC METHOD OF MEASUREMENT EMPLOYED IN THE 160-A Q-METER

An 8 range R.F. oscillator (E) supplies a heavy current (I) to an extremely low resistance load (R), the value of which is accurately known. The calibrated voltage thus developed across the load resistance (R) is coupled to a series circuit consisting of the inductance under test (L) and a calibrated variable air capacitor (C₀), having a vernier section (C₁). When this series circuit is tuned to resonance by means of the capacitor (C₀ + C₁), the "Q" of the inductance under test is indicated directly by the vacuum tube voltmeter (V). Variations of this basic method of measurement are used to measure inductance, capacitance and resistance.

SPECIFICATIONS

Oscillator Frequency Range: 50 kc. to 75 mc. in 8 ranges.

Oscillator Frequency Accuracy: $\pm 1\%$, 50 kc. — 50 mc.

$\pm 3\%$, 50 mc. — 75 mc.

Q-Measurement Range: Directly calibrated in Q, 20–250; "Multiply-Q-By" Meter (I) calibrated in tenths from x1 to x2, and also at x2.5; extending Q range to 625.

Q-Measurement Accuracy: Approximately 5% for direct reading measurement, for frequencies up to 30 mc. Accuracy less at higher frequencies.

Capacitance Calibration Range: Main capacitor section (C₀) 30–450 mmf accuracy 1% or 1 mmf whichever is greater.

Vernier capacitor section (C₁) +3 mmf, zero, —3 mmf, calibrated in 0.1 mmf steps. Accuracy ± 0.1 mmf.



DESIGNERS AND MANUFACTURERS OF THE "Q" METER . . . QX-CHECKER . . . FREQUENCY MODULATED SIGNAL GENERATOR . . . BEAT FREQUENCY GENERATOR . . . AND OTHER DIRECT READING TEST INSTRUMENTS

★ ANSONIA ★ Ankoseal

Flexible in Use...

Flexible in Application...

Proved in

many difficult installations,

Ansonia Ankoseal insulated wires

and cables retain their flexibility

though subject to a wide range of

temperatures, hard usage

and frequent bending

and twisting.

Wide flexibility in application is another value exceptionally true of Ansonia Ankoseal.

FOR

Control Cables

Cables requiring high dielectric strength, unusual resistance to heat, moisture, acids, alkalis and other destructive agents.

High Frequency Transmission

Portable Cables

Ankoseal provides an insulation adaptable to the requirements of each application.



Ansonia not only offers Ankoseal to meet a variety of insulating problems but our engineering staff has designed many cables for specific purposes.

You are invited to consult us regarding your wire or cable problems.

THE ANSONIA ELECTRICAL DIVISION

ANSONIA, CONNECTICUT of

NOMA ELECTRIC CORPORATION, NEW YORK, N. Y.

NOW AVAILABLE!

Centralab's medium-duty power switches for special industrial and electronic uses!

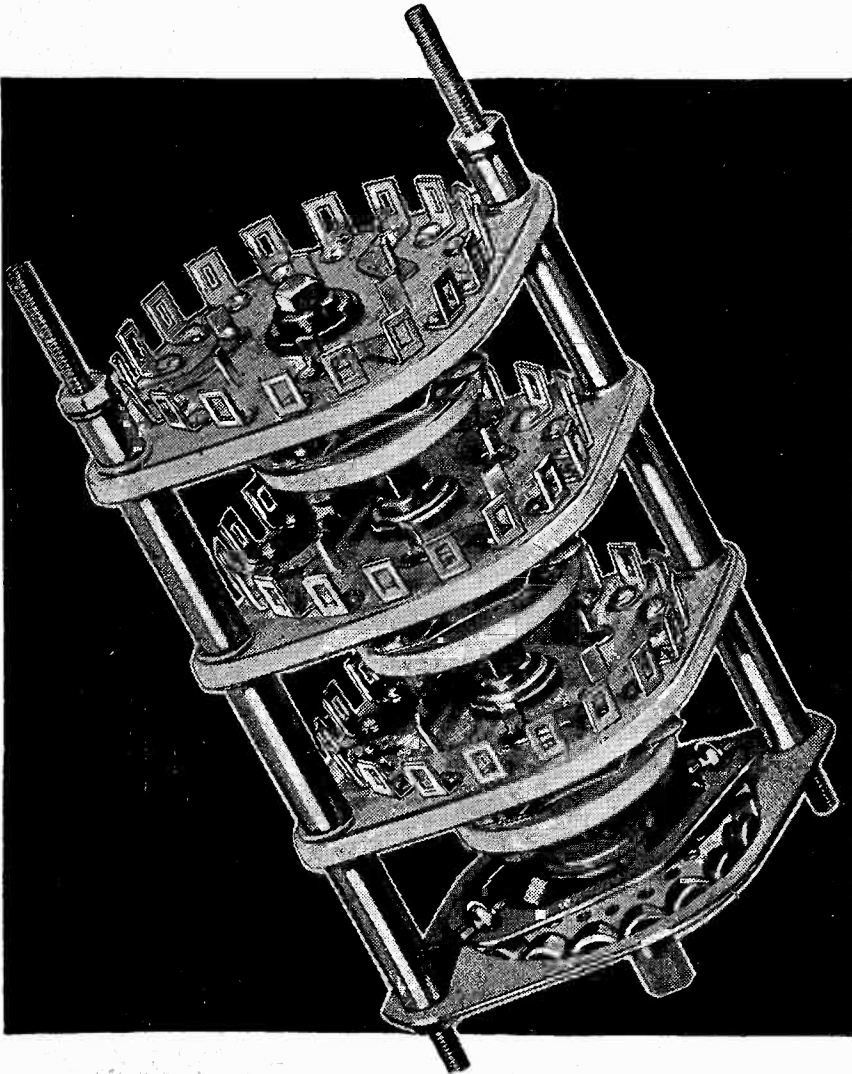

Efficient performance up to 20 megacycles — specially designed for transmitters, power supply converters, X-ray equipment etc.

HERE THEY ARE — Centralab's famous medium-duty power switches — now ready for a broad new range of industrial and electronic uses!

Look at some of the exclusive features which these sturdy switches offer you: 1) for accurate positioning, square operating shaft snugly fits staked sleeve in steatite rotors. 2) for peak performance, solid silver contacts are individually aligned and adjusted. 3) for flexibility, units can be assembled with shorting or non-shorting contacts. Switching combinations are 1 pole, 17 positions—and 3 poles, 5 positions per section. 20° double roller indexing.

Tests prove that these power switches have a minimum life operation of 25,000 cycles without failure. Switches have single hole bushing mounting, and tie rod extensions at front and rear serve as locating keys and added mounting support. Furnished with cadmium plated, steel and brass parts. Units in non-corrosive metals also available.

RATINGS: 7½ amperes at 60 cycles, 115 volts A.C. Minimum voltage breakdown between critical points is 3,000 volts RMS, 60 cycles. See how these fine Centralab switches can fit your industrial and electronic needs. Write today for Centralab's complete switch bulletin number 722!

Positive Action — Solid Silver Contacts

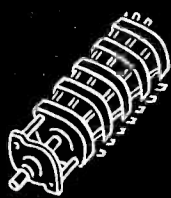
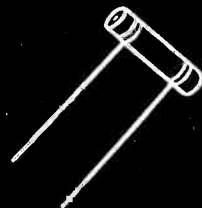
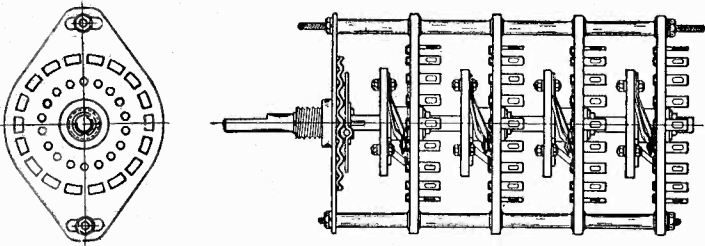

Centralab
Division of GLOBE-UNION INC., Milwaukee

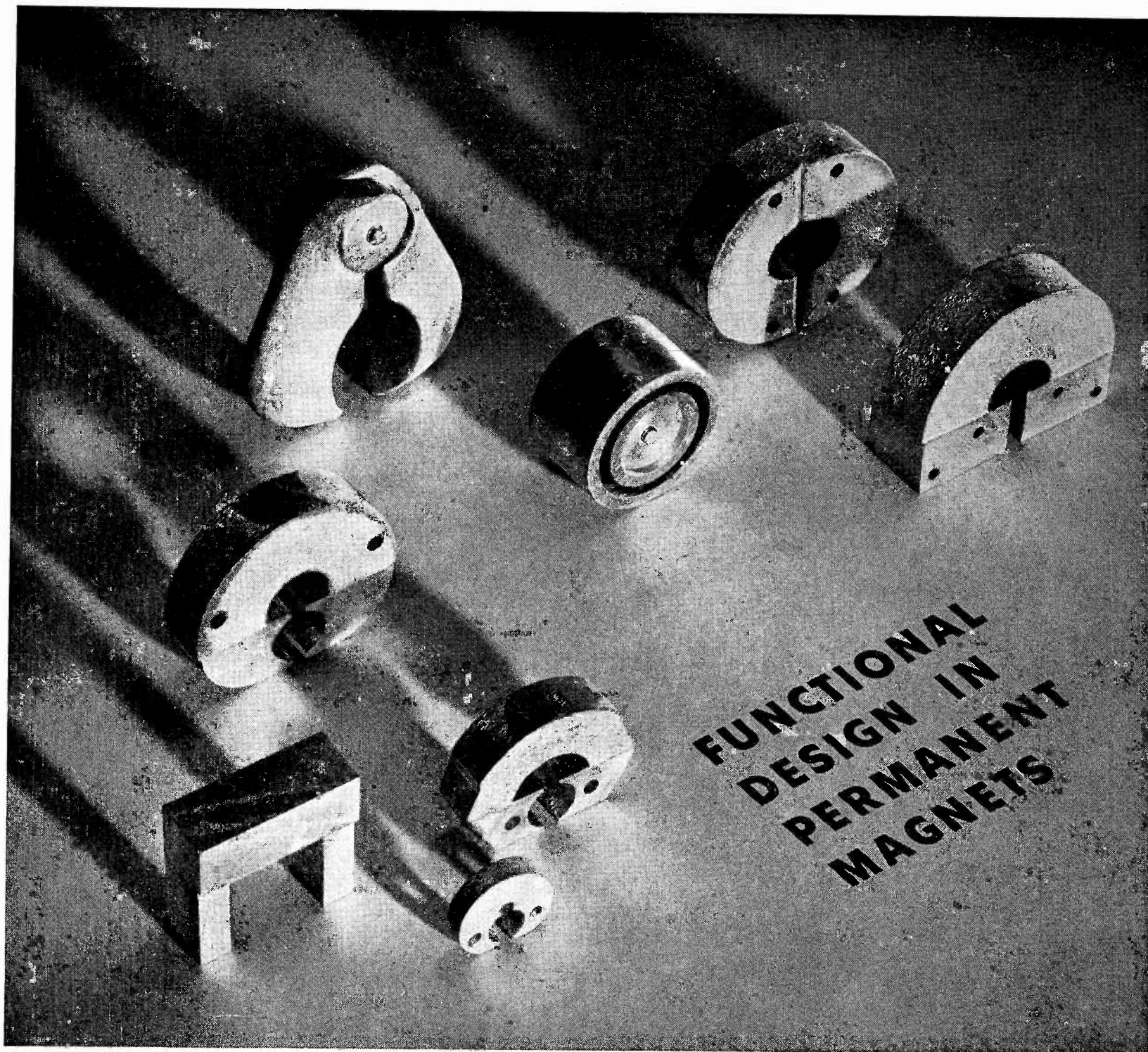

The efficiency of every instrument or device in which a permanent magnet is used depends upon the functioning of the magnet itself. *Functional designing* on soundly engineered principles is important in the production of permanent magnets for better, more efficient and economical performance.

The permanent magnet assemblies, shown above, serve both electrical and mechanical requirements. Those designed for the precise operation of test meters must maintain a constant energy source with the magnetic field. Extreme care must be taken in the shaping of these magnets for the desired effect.

Other magnets in which the holding power is

the main objective are so constructed that the magnetic circuit permits a far greater applied energy than the magnets themselves can supply. Further applications in which the magnet through its attraction and repulsion acts on other moving parts of an assembly require different design techniques.

The development of new magnetic materials—*Alnico, Cunico, Cunife, Vectolite* and *Silmanal*—has enabled our engineers to adapt permanent magnets to many uses which were formerly impractical.

The Indiana Steel Products Company welcomes the opportunity to help you solve your magnet problems with "Packaged Energy".

Copyright 1947, The Indiana Steel Products Co.

THE INDIANA STEEL PRODUCTS COMPANY

PRODUCERS OF "PACKAGED ENERGY"

6 NORTH MICHIGAN AVENUE * CHICAGO 2, ILL.



SPECIALISTS IN PERMANENT MAGNETS SINCE 1910

PLANTS

VALPARAISO, INDIANA

STAMFORD, CONN. (CINAUDAGRAPH DIV.)

Efficient electronic designing can begin with

CHATHAM RECTIFIERS



TELEVISION

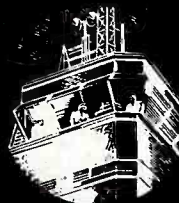

COMMUNICATION



BEAMS & BEACONS

For example, the three tubes illustrated are typical CHATHAM Xenon-filled rectifiers now affording simple solutions to difficult high voltage power supply problems. Available in a wide range of types that meet practically any rectifier requirement, CHATHAM Xenon rectifiers and thyratrons operate efficiently in ambient temperatures from -75°C to $+90^{\circ}\text{C}$. Within these temperatures no heaters, blowers or other temperature controls are required to maintain bulb temperature. Xenon gas and excellent design afford complete freedom from arc back, providing tube ratings are not exceeded.

In addition to Xenon rectifiers, CHATHAM manufactures a complete line of Mercury Vapor rectifiers and thyratrons, high vacuum rectifiers and special purpose tubes. Complete facilities are available for collaboration in the development of rectifiers of special design. Inquiries are invited; phone, write or wire your requirements.

CHATHAM ELECTRONICS

475 WASHINGTON ST., NEWARK 2, NEW JERSEY



SEND FOR YOUR COPY OF THE
NEW CHATHAM CATALOG TODAY

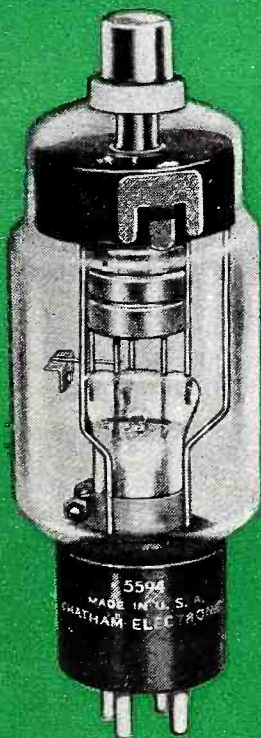

5594 THYRATRON—

PEAK FORWARD ANODE
VOLTAGE: 2500 VOLTS
PEAK INVERSE ANODE
VOLTAGE: 5000 VOLTS
AVERAGE ANODE CURRENT:
0.5 AMPERES
PEAK ANODE CURRENT: 2.0 AMPERES
FIL. VOLTAGE: 2.5 VOLTS

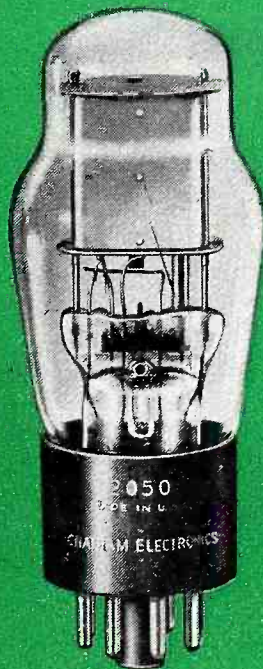

2050 THYRATRON—

PEAK FORWARD ANODE
VOLTAGE: 650 VOLTS
PEAK INVERSE ANODE
VOLTAGE: 1300 VOLTS
AVERAGE ANODE CURRENT:
100 MILLIAMPERES
PEAK ANODE CURRENT:
500 MILLIAMPERES
HEATER: 6.3 VOLTS



2D21 THYRATRON—

PEAK FORWARD ANODE
VOLTAGE: 650 VOLTS
PEAK INVERSE ANODE
VOLTAGE: 1300 VOLTS
AVERAGE ANODE CURRENT:
100 MILLIAMPERES
PEAK ANODE CURRENT:
500 MILLIAMPERES
HEATER: 6.3 VOLTS

Centralab reports to

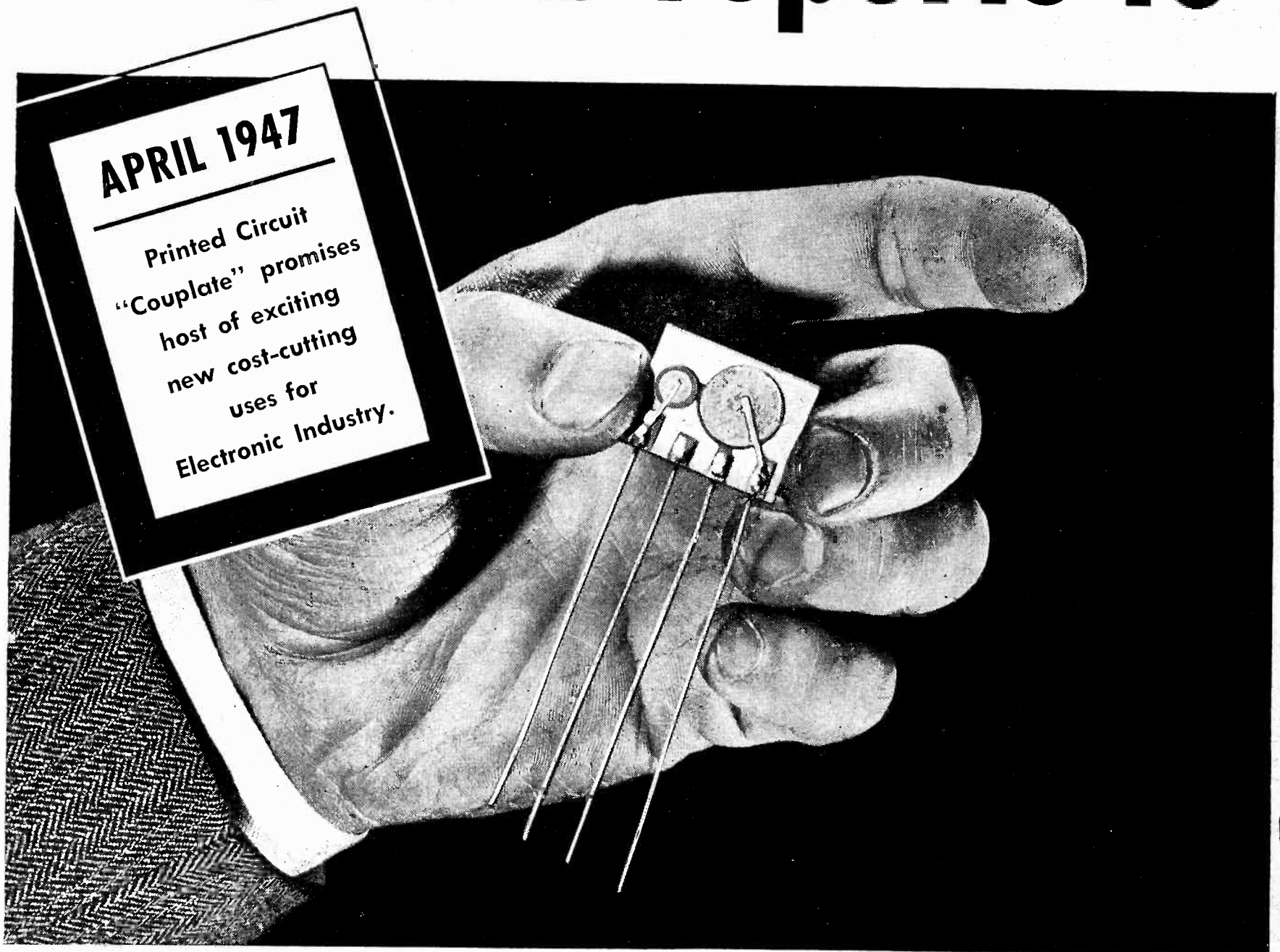

1 As revolutionary as the multi-purpose tube—that's what electronic engineers are saying about Centralab's new *Couplate*. Now available for the first time, the *Couplate* is a complete interstage coupling circuit which combines into one unit the plate load resistor, the

grid resistor, the plate by-pass capacitor and the coupling capacitor. For today's manufacturers, the *Couplate* saves up to five soldered connections, increases labor efficiency 50%, assures fast, precision wiring on interstage couplings.

FRONT

BACK

**NOW SEE HOW
THIS REPLACES THIS**

- C₁**—Coupling Capacitor, .01 mfd. is standard.
- C₂**—Plate R.F. By-Pass Capacitor, 250 mmf. ± 20% is standard.
- R₁**—Plate Load Resistor, 250,000 Ohms ± 20% 1/5 watt is standard.
- R₂**—Grid Resistor, 500,000 Ohms ± 20% 1/5 watt is standard.

Other Values Available

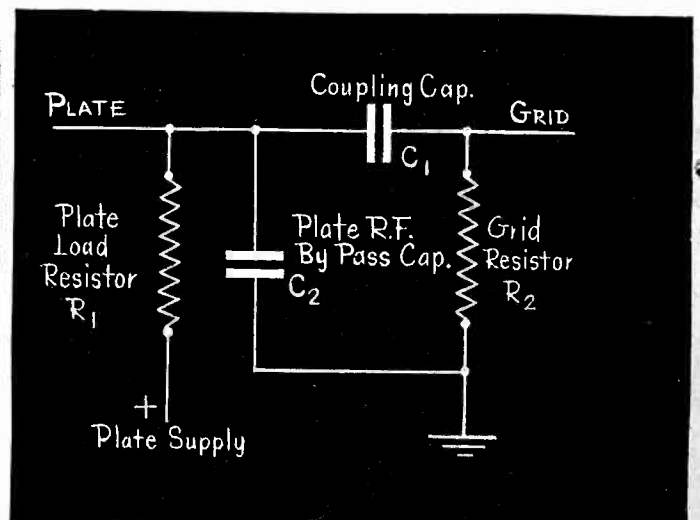

2 Integral Ceramic Construction: Each *Couplate* is an integral assembly of "Hi-KAF" capacitors and resistors closely bonded to a steatite ceramic plate and mutually connected by means of metallic silver paths "printed" on the base plate. Think of what that means in terms of time and labor saving...

3 Only four soldered connections are now required by the *Couplate* instead of the usual eight or nine (see above). That means fewer errors, lower costs!

Electronic Industry

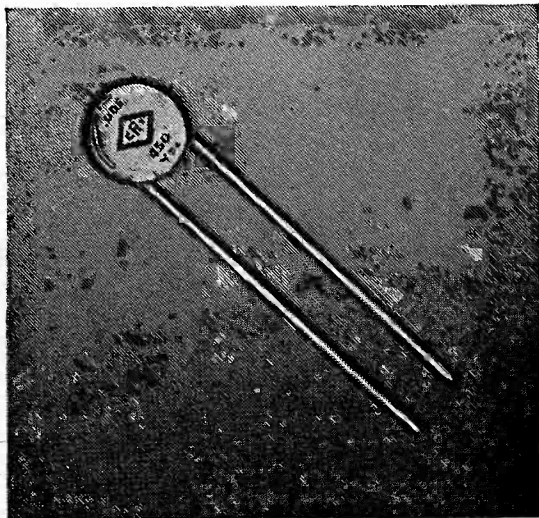

Look at "HI-KAP" Performance, Ratings, Convenience of Design!

Diameter (Max. O. D.)	$\frac{5}{8}$ "
Thickness (Maximum)	$\frac{5}{32}$ "
W. V. D. C.	450
Guaranteed Min. Capac.	.005
Flash Test V. D. C.	900
Weight (Average)	1 gm. .035 oz.

Other capacity values available. Inquire now!

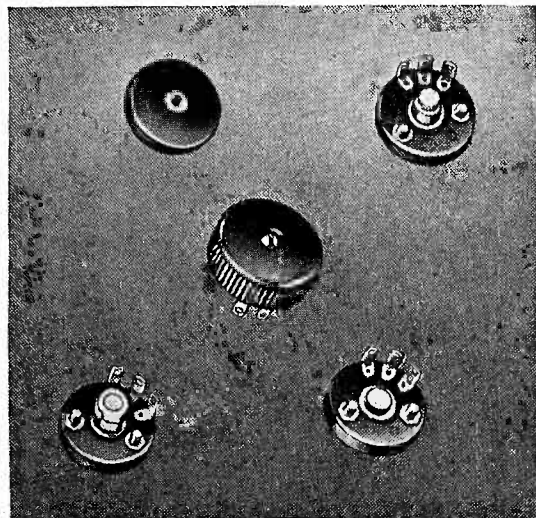

4 In addition — Centralab has just announced a sensational new quality line of miniature ceramic-disc capacitors impervious to moisture...

5 Hi-KAP's permanent Ceramic-X stability assures utmost reliability in small physical size and low mass weight. Write for Bulletin 933.

6 Here's Centralab's newest control for miniature receivers, amplifiers. No bigger than a dime, high quality performance is assured.

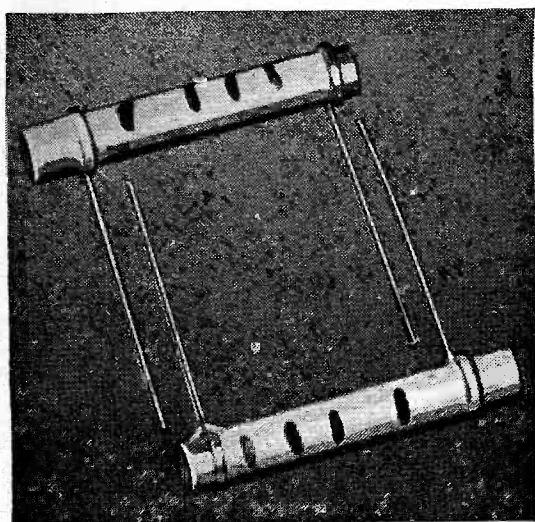

7 More news! The recognized dependability and high quality of ceramic bypass and coupling capacitors is now available at a new low price...



8 Made from Centralab's original Ceramic-X—result of our continuing research in high dielectric constant ceramics. Write for Bulletin 943.

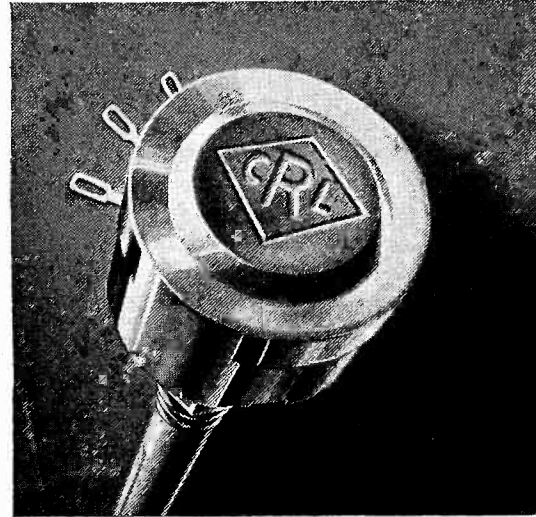

9 When you see this CRL monogram on electronic components, you're assured of tested performance, quality and dependability. Look for it!

Look to Centralab in 1947! First in component research that means lower costs for the electronic industry. If you're planning new equipment let Centralab's sales and engineering service work with you. Get in touch with Centralab!

Centralab

DIVISION OF GLOBE-UNION INC., MILWAUKEE, WIS.

Does your oscillograph have single or recurrent sweep frequencies as low as 0.2 cycles per second? *IT CAN...*

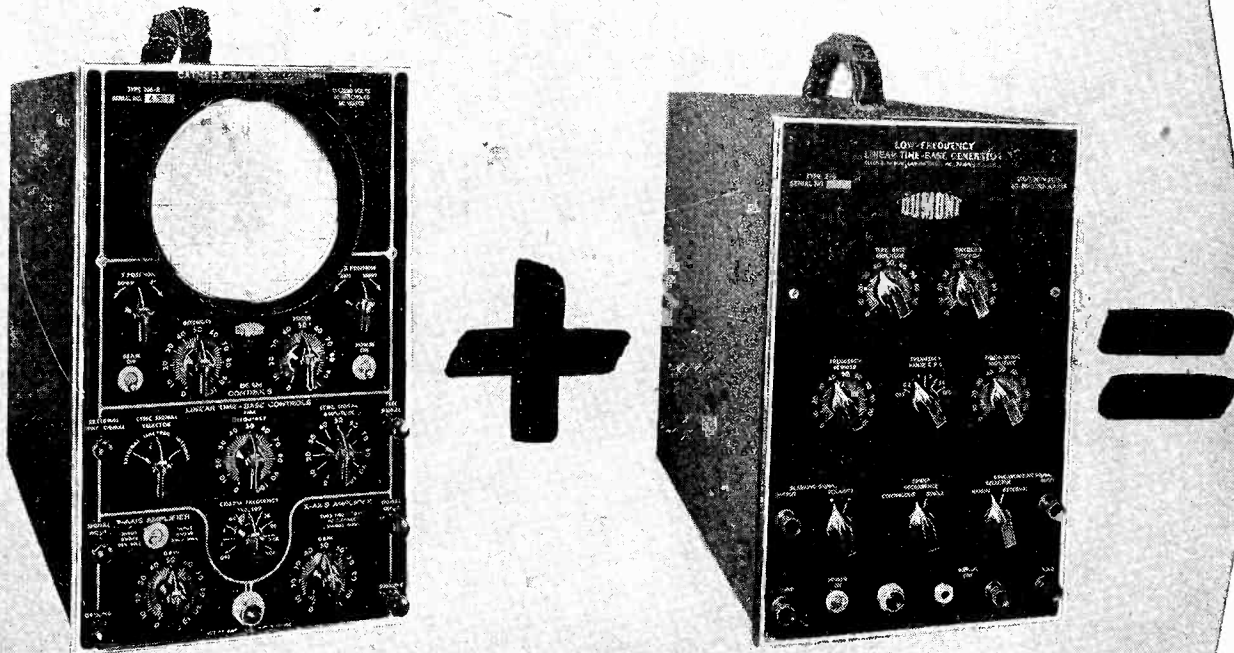

with the **DUMONT Type 215**
LOW-FREQUENCY LINEAR-TIME-BASE GENERATOR

Here's the means for vastly increasing the usefulness of your already useful oscillograph.

This accessory instrument provides a 450 v. d.c. or peak-to-peak undistorted linear-time-base signal voltage of a frequency variable from 0.2 to 125 cycles per second! Special compensating circuit assures linearity.

The single sweep can be initiated either manually or by observed signal. The oscillograph-screen pattern can usually be spread out to three times' full

scale deflection. Return trace blanking signal of either positive or negative phase.

For single sweep, and for low-frequency recurrent-sweep studies, the DuMont Type 215 Low-Frequency Linear-Time-Base Generator used in combination with the DuMont Type 208-B general purpose oscillograph, or equivalent, provides excellent results. Note the typical studies herewith. Definitely "must" equipment.

ALLEN B. DUMONT LABORATORIES, INC.

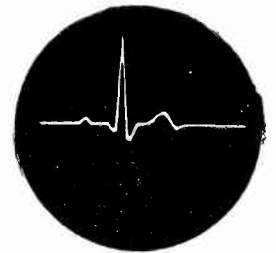

ELECTROCARDIOGRAPHY

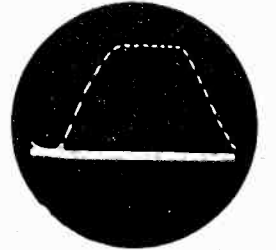

FLASH BULB CHARACTERISTICS

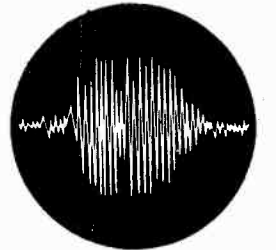

MACHINERY VIBRATION STUDY

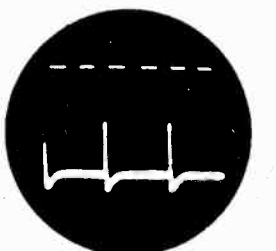

ELECTROENCEPHALOGRAPHY

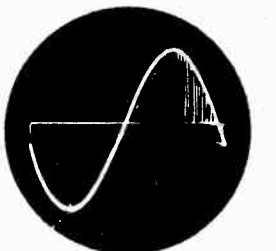

RELAY REBOUNCE STUDY

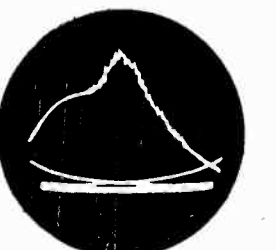

DIESEL ENGINE CYLINDER PRESSURE

Descriptive literature on request.

DUMONT Precision Electronics & Television
 ALLEN B. DUMONT LABORATORIES, INC., PASSAIC, NEW JERSEY • CABLE ADDRESS: ALBEDU, PASSAIC, N. J., U. S. A.

For Prompt Service

CONTACT THESE



REPRESENTATIVES

JOE DAVIDSON & ASSOCIATES

P. O. Box 108
South Gate, Calif.
Tel: Kimball 7244

ALLEN I. WILLIAMS, JR.

230 Cooper Building
Denver 2, Col.
Tel: Ma. 0343

J & M APPLIANCE CO.

516 North Field
Dallas 1, Texas

FRANK W. YARLINE & CO.

20 No. Wacker Drive
Chicago 6, Ill.
Tel: State 0347

HARRIS-HANSON CO.

427 No. Euclid Ave.
St. Louis 8, Mo.
Tel: Forest 5841

ENGINEERING SALES CO.

124 No. Montgomery St.
Trenton 8, N. J.
Tel: Trenton 9885

HOLLIDAY-HATHAWAY SALES CO.

238 Main Street
Cambridge 42, Mass.
Tel: Eliot 1751

GEORGE T. WRIGHT

19859 Beach Cliff Blvd.
Cleveland 16, Ohio
Tel: Boulevard 9554

WILLIAM J. COTTRELL CO.

309 S. W. Third Avenue
Portland 4, Oregon

AIRPARK CORPORATION

412—5th Street, N.W.
Suite 501
Washington, D. C.

EAD MOTORS

A RELIABLE

POWER SOURCE for

AUTOMATIC VENDING MACHINES

VOICE-O-GRAPH

International Mutoscope Corp.
Long Island City 1, N. Y.

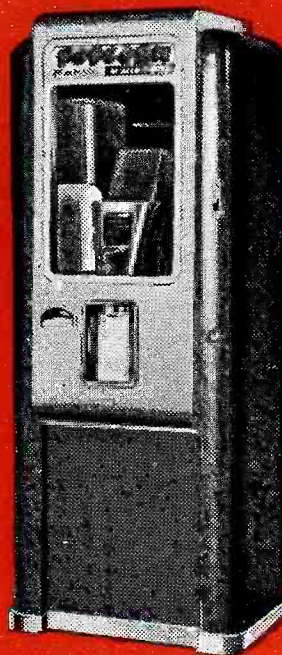

MINIT POP

The Viking Tool
& Machine Corp.
Belleville 9, N. J.



PEA-MOR PHONOGRAPH

Packard Manufacturing Corp.
Indianapolis 7, Ind.

EASTERN AIR DEVICES

motors have won wide acceptance for their efficient performance and ease of maintenance in automatic vending machines such as those illustrated. Their construction includes such desirable features as: squirrel cage motor without switches or brushes resulting in no commutator trouble or creation of radio interference, replaceable "capsule" bearings; snap ring construction for easy disassembly and improved cooling means, insuring long life and quiet operation with minimum size and weight. Let us fit an E.A.D. motor to your application.

70 series

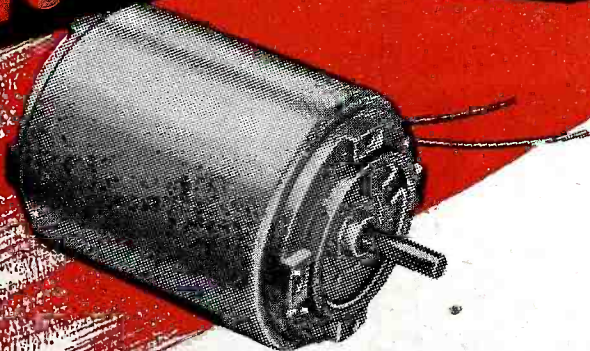

EASTERN AIR DEVICES, INC.
585 DEAN STREET • BROOKLYN 17, N. Y.

TYPE NO.	TYPE	H.P.	SPEED
LS71TCJ-1	Synchronous	1/75	1800
L731M-1	Capacitor	1/40 ^{High Torque}	1600
L73LC-1	Capacitor	1/30	1600

LET BENTLEY, HARRIS WAR-TIME RESEARCH PAY DIVIDENDS FOR YOU TODAY.

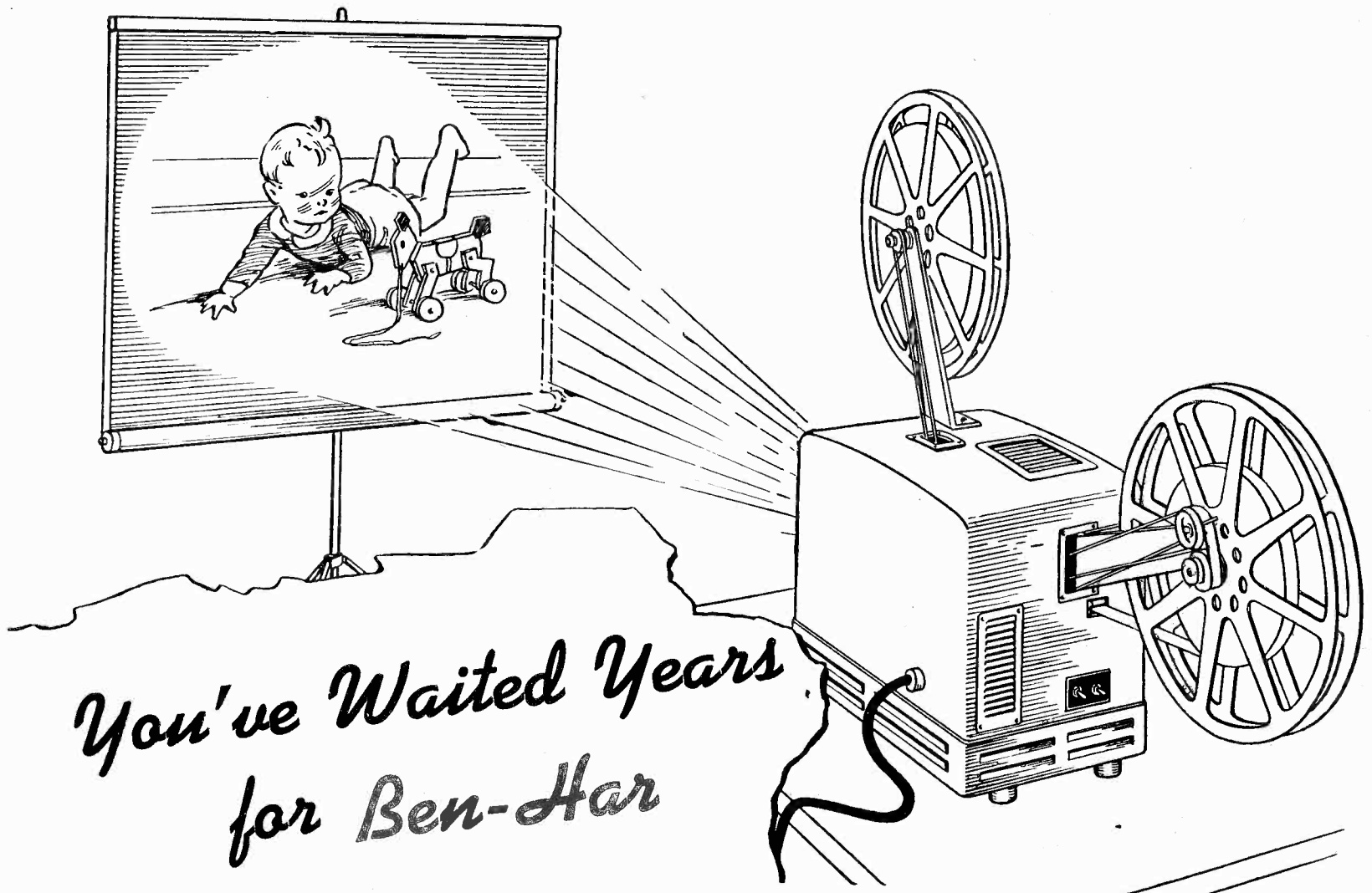

*You've Waited Years
for Ben-Har*

A manufacturer of home-type movie projectors recently brought this problem to Bentley, Harris: Provide an insulation that will withstand intense heat without stiffening and cracking, that will not fray or split under rough handling, and will remain unaffected by minor, but constant, vibration.

After testing a sample of Ben-Har Special Treated Fiberglas Tubing under actual production and operating condition, this is what the manufacturer found: Ben-Har gives consistently superior results. It has solved the problems of heat, rough handling, and other common causes of insulation breakdown. The great flexibility of Ben-Har has aided production considerably, since much of the work is done in cramped places and the insulation must spread to cover knobs and terminals.

Non-fogging, non-corrosive Ben-Har is not affected by heat conducted through the wire and will not burn, even in direct contact with flame. Its extreme flexibility and high dielectric strength prove the value of this insulation by daily use in a wide variety of applications—from hearing aids to electric motors, from watt-hour meters to television receivers.

Try Ben-Har Special Treated Fiberglas Tubing in your plant, in your own product—under actual service conditions. Learn why America's leading manufacturers of home appliances and industrial equipment say "never before a tubing like Ben-Har".

BENTLEY, HARRIS MFG. CO., CONSHOHOCKEN, PA.

BH *Fiberglas** SLEEVINGS

*BH Non-Fraying Fiberglas Sleeveings are made by an exclusive Bentley, Harris process (U. S. Pat. No. 2393530). "Fiberglas" is Reg. TM of Owens-Corning Fiberglas Corp.

USE COUPON NOW

Bentley, Harris Mfg. Co., E-9, Conshohocken, Pa.

I am interested in Ben-Har Special Treated Fiberglas Tubing _____ for _____
(size) (product)
operating at temperatures of _____°F. at _____ volts. Send samples so I can see for myself
how Ben-Har will not crack in a bend, will not support combustion.

NAME _____ COMPANY _____

ADDRESS _____

Send samples, pamphlet and prices on other BH Products as follows:

- Cotton-base Sleeveing and Tubing
- Non-fraying Fiberglas Sleeveing

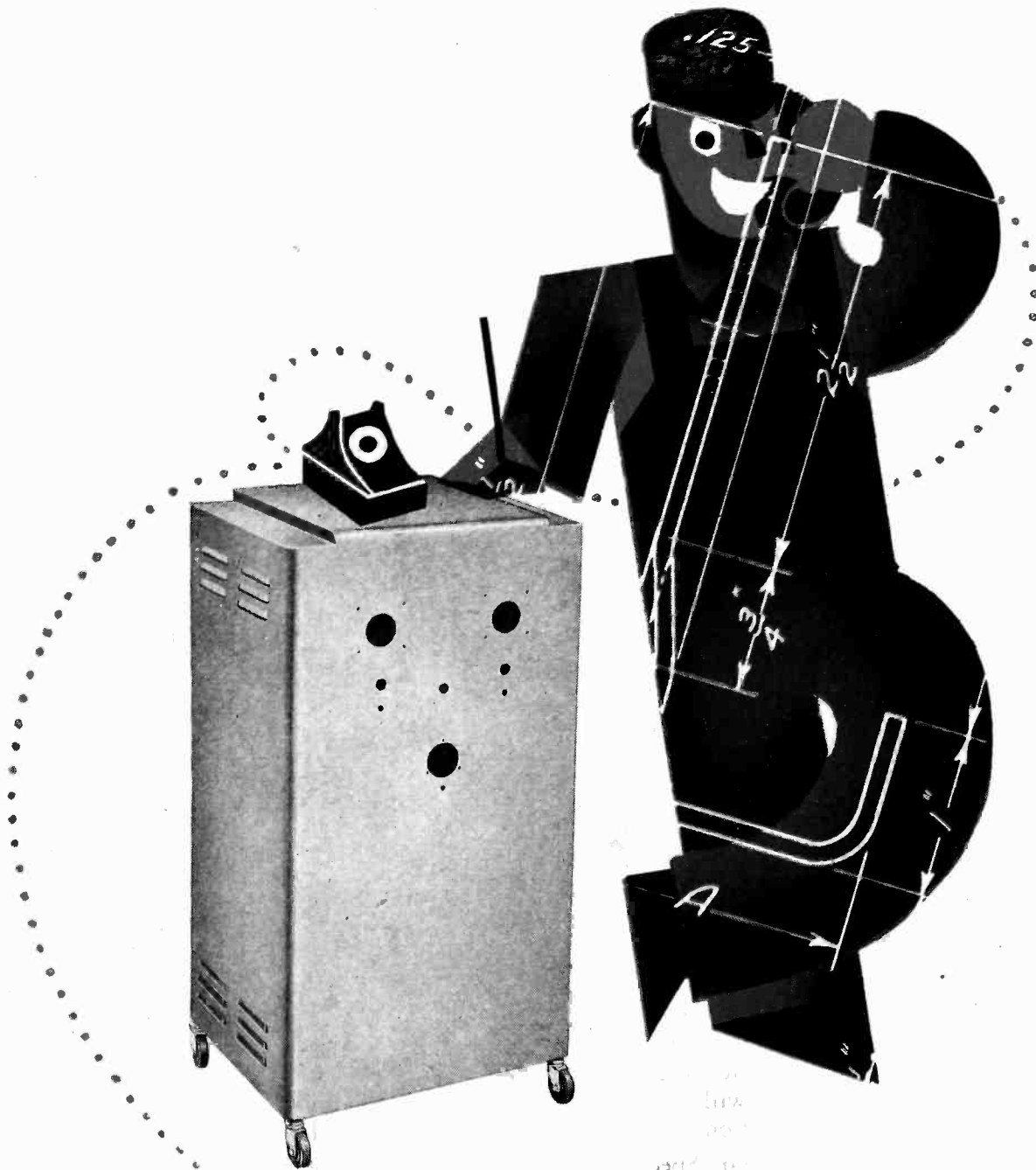

YOU'VE GOT THE RIGHT NUMBER

When you contact KARP for sheet metal fabrication, you have the right connection. You're in touch with highest quality custom craftsmanship — at prices comparable with stock items.

You're doing business with an organization with 22 years experience in specially fabricated sheet metal cabinets, chassis, housings, racks and enclosures for manufacturers of electronic, radio and electrical apparatus.

You're getting the benefit of a valu-

able amount of "know-how" in engineering and design . . . suggestions to help you keep your assemblies a step ahead in streamlined styling and long service life. You have at your disposal a large accumulation of dies and tools which may cut your costs considerably.

Give us a call on your next job. And if you can't call, write.

*Any Metal • Any Gauge • Any Size
Any Finish • Any Quantity*

Karp

METAL PRODUCTS CO., INC.

Custom Craftsmen in Sheet Metal . . .

124 - 30th STREET, BROOKLYN 32, NEW YORK

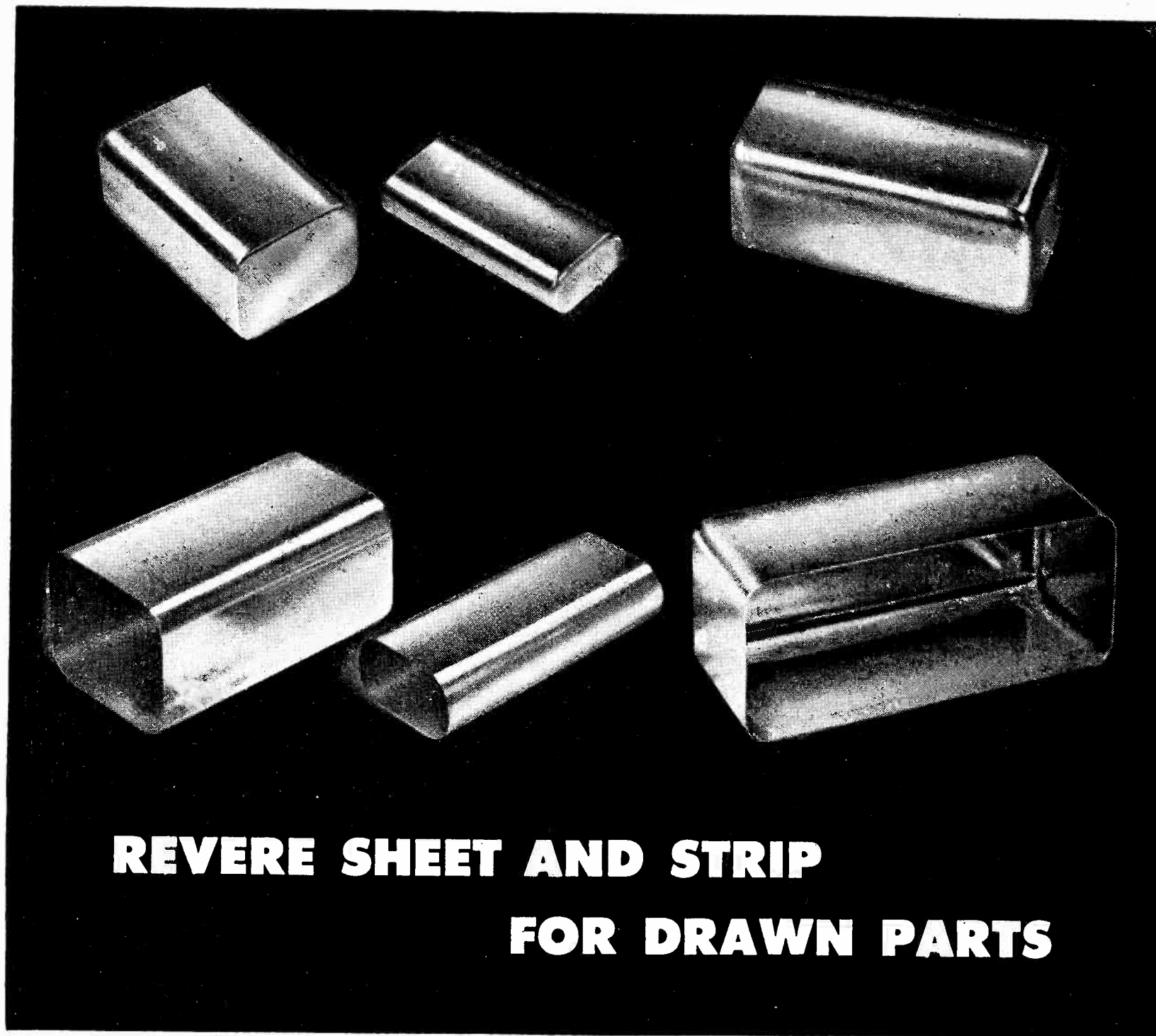

REVERE SHEET AND STRIP FOR DRAWN PARTS

FOR all products to be made by drawing, stamping and similar sheet metal operations, Revere sheet and strip of copper or brass offer maximum ease of fabrication. Not only are these metals naturally ductile, but they benefit further from the metallurgical skill which Revere has gained in 145 years of experience.

In composition, mechanical properties, grain size, dimensions and finish, you will find Revere metals highly uniform. They enable you to set up economical production methods and adhere to them. They can help you produce better products at faster production rates, with less scrap and fewer rejects.

Revere copper, brass and bronze lend themselves readily to the widest variety of finishing operations—polishing, lacquering, electro-plating. With these superior materials it is easy to

make radio shields and similar products beautiful as well as serviceable.

That is why wise buyers place their orders with Revere for such mill products as—*Copper and Copper Alloys*: Sheet and Plate, Roll and Strip, Rod and Bar, Tube and Pipe, Extruded Shapes, Forgings—*Aluminum Alloys*: Tubing, Extruded Shapes, Forgings—*Magnesium Alloys*: Sheet and Plate, Rod and Bar, Tubing, Extruded Shapes, Forgings—*Steel*: Electric Welded Steel Tube. We solicit your orders for these materials.

REVERE

COPPER AND BRASS INCORPORATED

Founded by Paul Revere in 1801

230 Park Avenue, New York 17, New York
Mills: Baltimore, Md., Chicago, Ill.; Detroit, Mich.;
New Bedford, Mass.; Rome, N. Y.

Sales Offices in Principal Cities, Distributors Everywhere

SINCE
1895

THORDARSON

THE OLDEST MANUFACTURER OF QUALITY
TRANSFORMER EQUIPMENT IN THE UNITED STATES

For well over fifty years Thordarson has been turning out the finest in amateur and industrial transformer equipment. Founded in 1895 by Chester Thordarson, designer of the first amateur transmitting transformer, this company has pioneered many new developments, including the superior coil and core materials now used in its entire line. Describing quality transformers for every ham requirement, the Thordarson catalog is still regarded as the "bible" of the radio amateur.

In the industrial field, Thordarson was first to design and build transformers for specific applications. To this day, when there is a question of correct transformer design, Thordarson is usually consulted first. Thordarson Amplifiers, a logical outgrowth of this vast transformer manufacturing experience, are regarded by experts as the finest in present-day sound equipment.

In the future, as in the past, Thordarson Transformers and Amplifiers will continue to be manufactured to the same high standards which have distinguished their production from the beginning. When you specify Thordarson you will always be sure of obtaining a product which is as perfect as a half century of electronic manufacturing experience can make it.

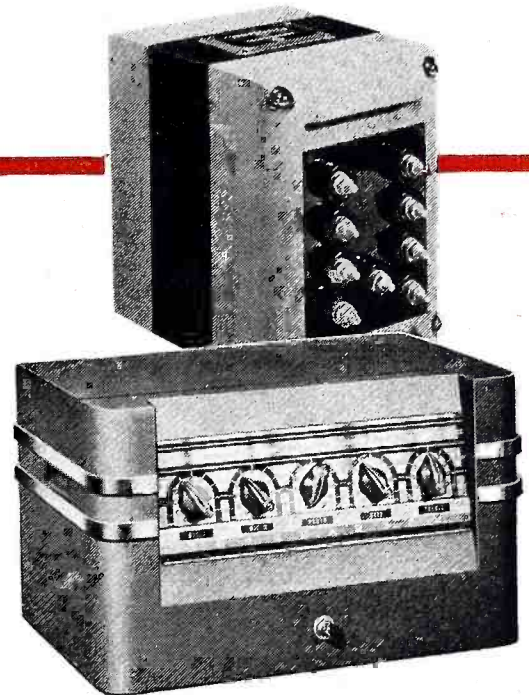

Thordarson Transformers and Amplifiers are designed for every electronic application

THORDARSON

ELECTRONIC DISTRIBUTOR AND INDUSTRIAL SALES DEPARTMENT
MAGUIRE INDUSTRIES, INC. 936 NORTH MICHIGAN AVENUE
CHICAGO 11, ILLINOIS

EXPORT SALES DIVISION • SCHEEL INTERNATIONAL INCORPORATED
4237-39 N. LINCOLN AVENUE, CHICAGO 18, ILL. CABLE ADDRESS HARSHEEL

End Results are Ward Leonard's Business!

"**R**esult **E**ngineering"

HAS DUAL OBJECTIVE

If your product's assembly cost might be lowered or its performance improved by a modification of a basic design in any electric control component—the answer may well be in Ward Leonard's "result-engineering". Given the result desired, Ward Leonard engineers aim to help you accomplish it through

MANUFACTURE

using manufacturing methods which give greater assurance of the expected result.

DESIGN

adapting basic designs to fit your product assembly and performance requirements.

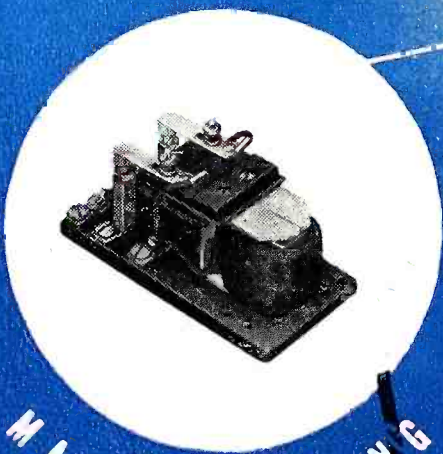

MANUFACTURING

ONE RELAY WILL DO ALMOST ANYTHING

Ward Leonard's 130 relay can be adapted to any of a wide variety of individual requirements merely by the proper selection of certain interchangeable parts. Use of one basic construction principle plus quantity production of parts gives you a relay that is both better and more economical. Your option includes a choice of one to four poles, 6 to 230 volts D.C., 6 to 440 volts A.C., single or double throw, normally open or closed, with or without blowout coils, etc.

RESULT: custom requirements met without prohibitive cost or undue delay in delivery.

WARD LEONARD ELECTRIC CO.

Where Basic Designs in Electric Controls

THE CENTRIFUGE WON'T SPILL

Trouble had been experienced due to carelessness in stopping a centrifuge. Instead of turning the speed regulating rheostat back to the "off" position, the operator would open a line switch or pull a plug. Upon resuming the "spin", the abrupt start might break the specimen holder, spill the contents or seriously overload the rheostat.

Ward Leonard, asked to furnish rheostats, recommended interlocking a relay with the rheostat contact arm and a standard 3-wire low-voltage protection relay.

RESULT: the centrifuge cannot be operated until the rheostat is returned to the starting position.

DESIGN

BLUE MEANS

"**R**esult
Engineering"

In resistors, rheostats, relays and other electric controls, the distinctive blue identifies Ward Leonard "result-engineering".

FREE BULLETINS on "Result-Engineered" Relays
(Please request on business letterhead, mentioning your title)

WARD LEONARD ELECTRIC CO.
MOUNT VERNON, NEW YORK

Offices in principal cities of U. S. and Canada



RESISTORS • RHEOSTATS
RELAYS • CONTROL DEVICES

are "result-engineered" for you

Now

a really simple,

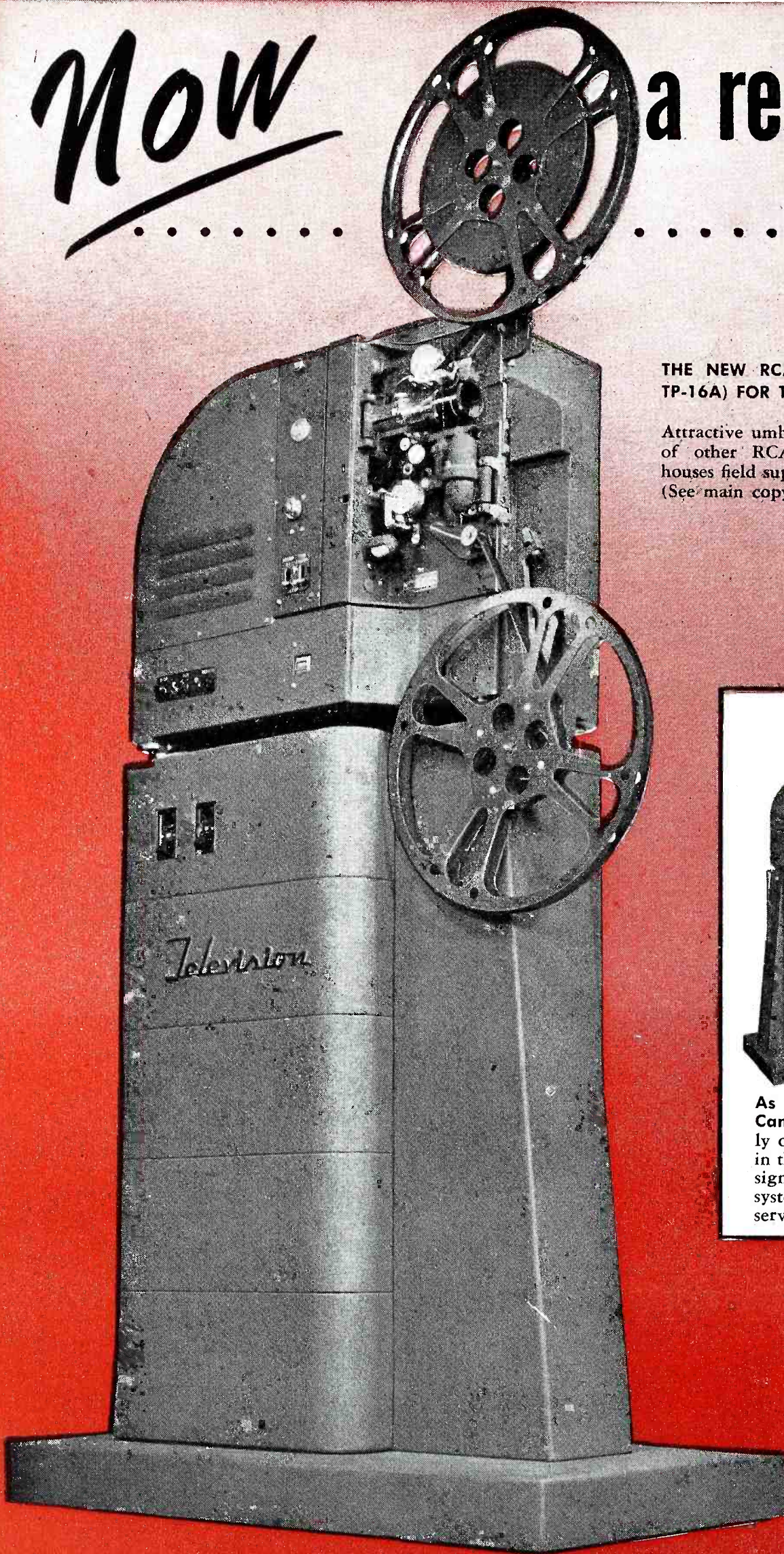

THE NEW RCA TELEVISION PROJECTOR (TYPE TP-16A) FOR TELECASTING 16mm SOUND FILMS

Attractive umber-gray, crackle-finish matches that of other RCA television equipments. Pedestal houses field supply and control circuits for motor. (See main copy).



As Used With RCA's TK-20A Film Camera. Pictures are projected directly on the mosaic of the pick-up tube in the film camera to obtain the video signal. By means of a mirror switching system, one camera can be used to serve a pair of projectors.

low-cost television projector

available for immediate delivery

Simplicity of operation, proved dependability, and low cost are the highlights of this new television tool.

With it you can take full advantage of the excellent program material now available on 16mm sound films. Newsreels, shorts, documentaries, and sound films on countless other subjects can be worked into your daily schedules to add program variety and to keep down costs.

The TP-16A Television Projector is a completely self-contained, streamlined unit designed especially to meet the exacting requirements of television stations. Features include:

- High-intensity optical system providing brilliant reproduction of pictures.
- Stabilized sound unit assuring unequalled sound quality.
- Simple, foolproof, film-feed system permitting quick, easy film threading.
- Dependability assured by using precision-made parts of design similar to those used in RCA's outstandingly successful sound film projector—the famous PG-201.

As shown by the diagram below, an ingeniously simple system is used to permit the required 60 field-per-second television scanning of standard 24 frame-per-second sound film. The 60 light flashes which must pass through the film every second are easily obtained with only three major parts: a 1000-watt projector lamp, a slotted rotary shutter to interrupt the light beam, and a large-size motor that acts as a shutter drive. There is no need for expensive pulse-forming circuits. The incandescent lamp furnishes plenty of brilliance for 16mm film. Perfect synchronization with the television system is assured by using the common power source to drive the shutter motor. No external synchronizing connections are required.

For better, easier film programming it will pay you to investigate this simplified projector. We'll be glad to send you complete price and descriptive data. Write: Dept. 30-D, Radio Corporation of America, Camden, New Jersey.



TELEVISION BROADCAST EQUIPMENT
RADIO CORPORATION OF AMERICA
 ENGINEERING PRODUCTS DEPARTMENT, CAMDEN, N. J.

In Canada: RCA VICTOR Company Limited, Montreal

PRINCIPLES OF OPERATION

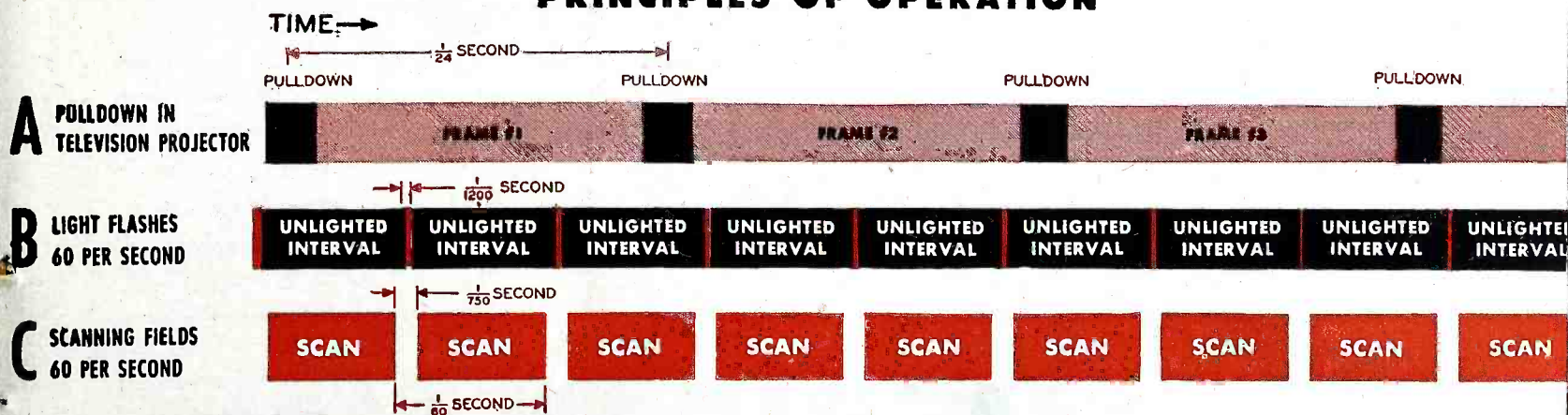

Line A illustrates how, by using a special intermittent mechanism, the "pull-down" time in the TP-16A is reduced to $\frac{1}{8}$ the "frame cycle." Line B indicates the duration and repetition rate of the short intervals during which light passes through the film. Line C shows the scanning intervals. Note that scanning takes place during the unlighted interval

following each flash. This is made possible by the "storage" property of the film camera pick-up tube. The first frame is scanned twice, the second frame three times, the third frame twice, etc., for an average rate of $2\frac{1}{2}$ scannings per frame. This rate multiplied by 24 frames per second provides the required 60 scanned fields per second.

Many Sunlamp Makers

(and users, too)

**are "Seeing
the Light"**



...by insisting on AMERICAN PHILLIPS SCREWS

PRODUCTION-WISE — add sunlamp manufacturers to the host of stove, refrigerator, furniture and other modern-minded makers who are cutting production costs via American Phillips Screws. How? By straight, sure-fire, speedy, *automatic* driving that's proof against scars, scuffs, work spoilage. No matter what the pace, the 4-winged American Phillips Driver "stays put" — can't harm or hinder work or worker . . . and you can count on *time savings up to 50%*!

PROMOTION-WISE — American Phillips Screws lend a modern touch — step up the "sell" of whatever you make. They can't snag clothes but they *do* snag orders! Showmanship and serviceability both say "specify American Phillips."

**4-WINGED DRIVER CAN'T SLIP OUT
OF PHILLIPS TAPERED RECESS**

AMERICAN SCREW COMPANY, PROVIDENCE 1, RHODE ISLAND

Chicago 11: 589 E. Illinois St.

Detroit 2: 502 Stephenson Bldg.

**AMERICAN
PHILLIPS**

Screws



ALL TYPES

ALL METALS: Steel, Brass, Bronze, Stainless Steel, Aluminum, Monel, Everdur (silicon bronze)

FIRST in producing a continuous electric current

ALESSANDRO VOLTA (1745-1827), great Italian physicist, in 1800 announced his discovery of a chemical cell for producing electricity. The voltaic pile, named in his honor, was the first electric battery. This first source of continuous electric current opened vast new horizons in the field of electrical research.

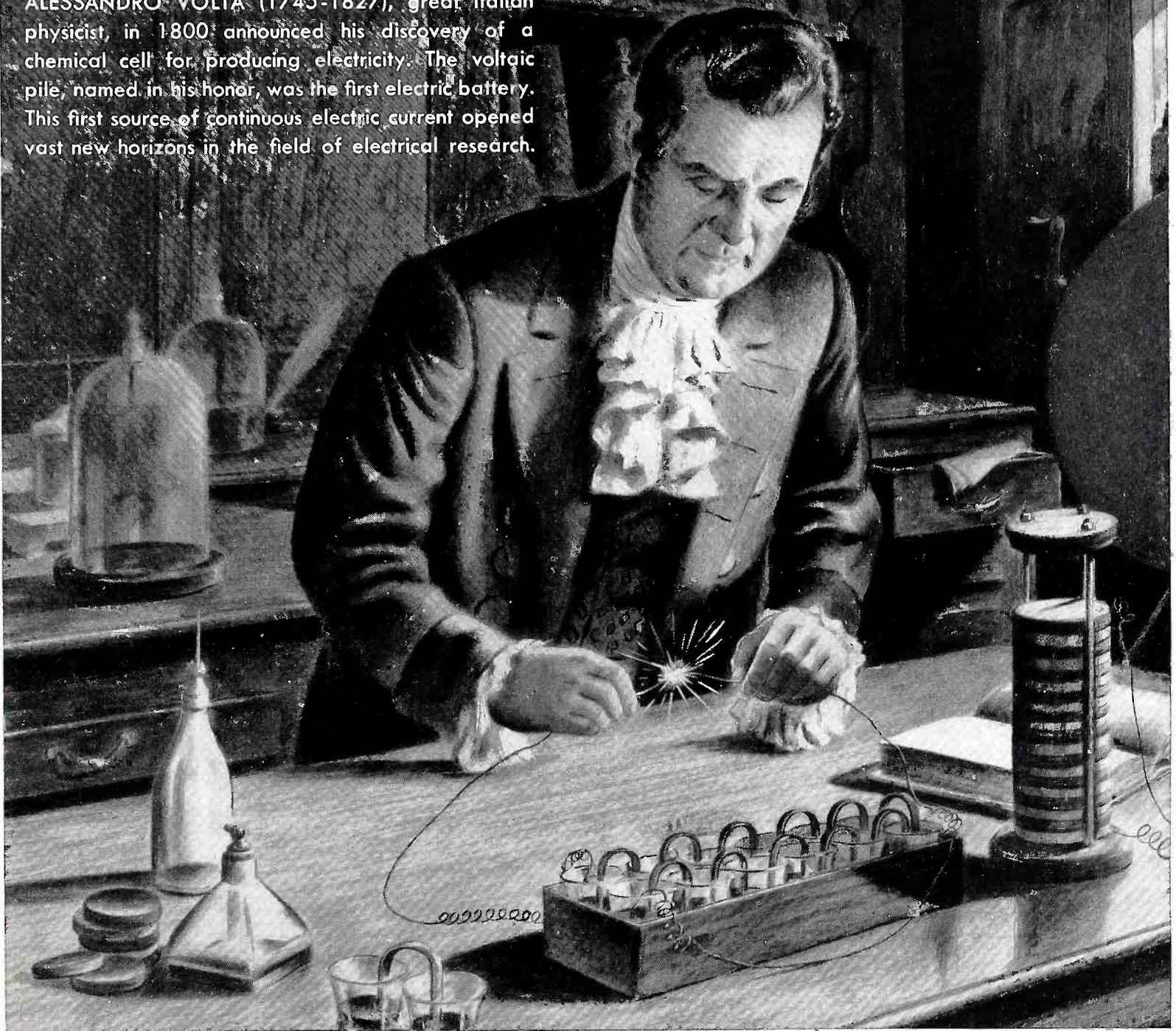

FIRST in Wire-Wound Resistors . . . Today

Ohmite offers the most complete line of wire-wound resistors on the market today—and these resistors have become industry's first choice. The primary reason for this popularity is that Ohmite resistors have proved their ability to give *extra* years of trouble-free service.

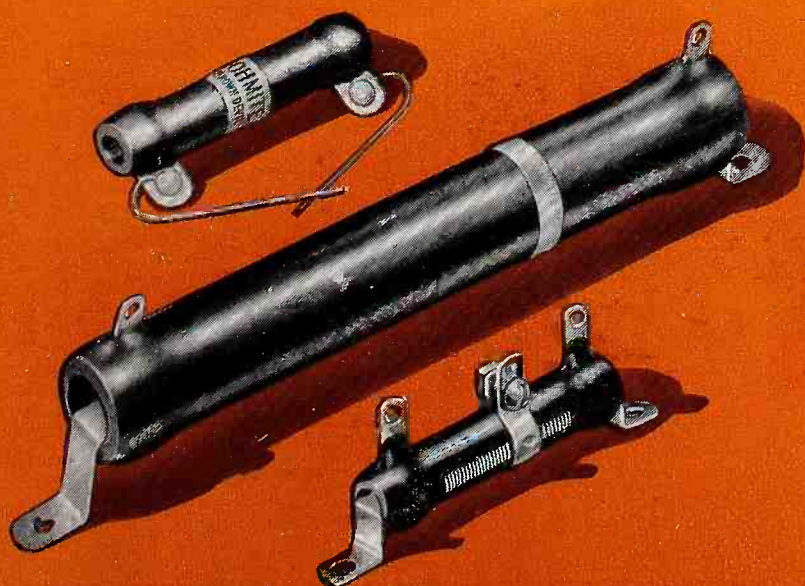

OHMITE

RHEOSTATS • RESISTORS • TAP SWITCHES

OHMITE

Resistors

Sizes and Types for Every Service

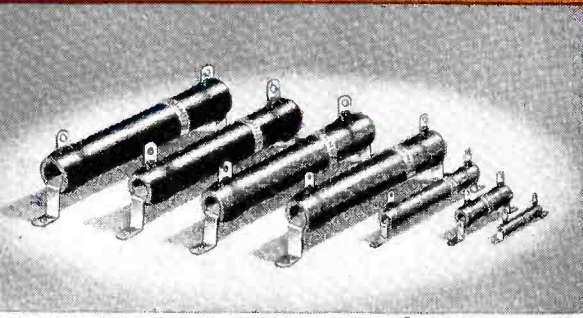

LUG TYPE

Most popular type for general purpose applications. Connected by soldering or bolting to lugs. Protected by vitreous enamel coating.

FERRULE TYPE

Winding terminated on metal bands for mounting in standard fuse clips. Provides easy interchangeability without tools.

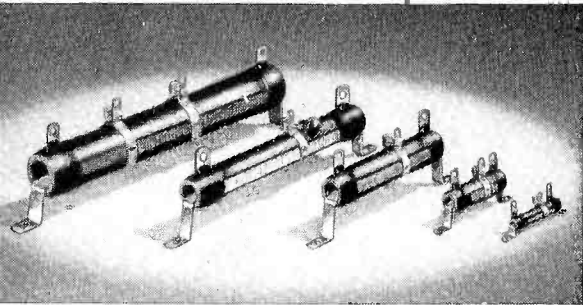
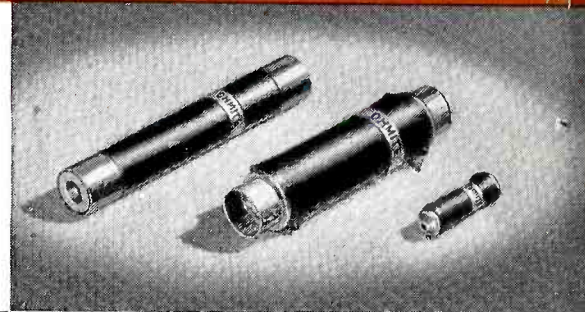

"DIVIDOHM" ADJUSTABLE TYPE

Provided with adjustable lugs for securing odd values of resistance quickly and easily.

EDISON BASE TYPE

Mounted in ordinary lamp type screw sockets for easy interchangeability without the use of tools.

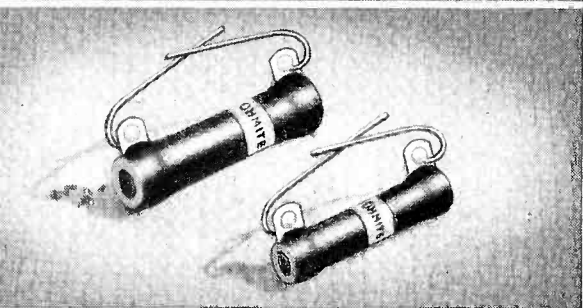
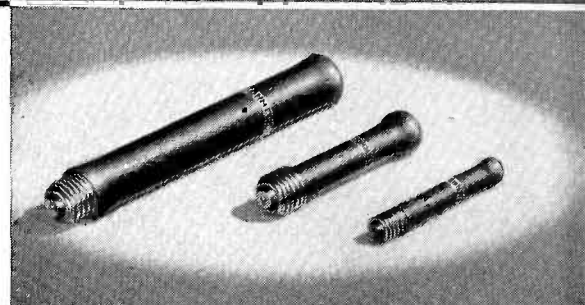

WIRE LEAD TYPE

Small vitreous enameled resistors which can be connected and supported by their own wire terminals. Maximum size approx. 20 watts.

PRECISION TYPE

Low wattage resistors of $\pm 1\%$ or closer tolerance. Made in vacuum impregnated, glass sealed, or vitreous enameled type units.

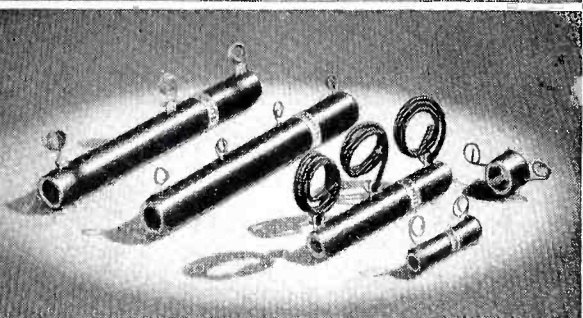
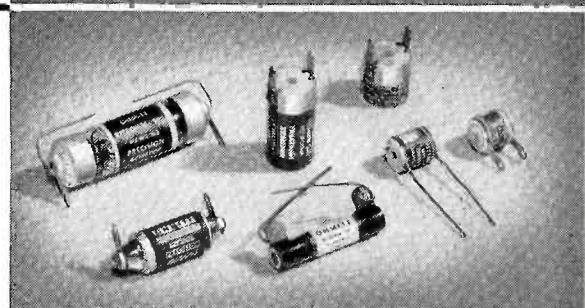

FLEXIBLE LEAD TYPE

Winding is connected to stranded bare or insulated leads. Used where it is desired to have connecting wires a part of the resistor.

BRACKET TYPE

Have metal end brackets. Live bracket type is connected by bolting brackets to panel terminals. Dead bracket type has separate lugs.

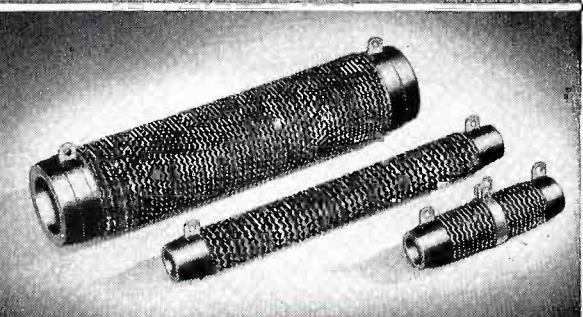
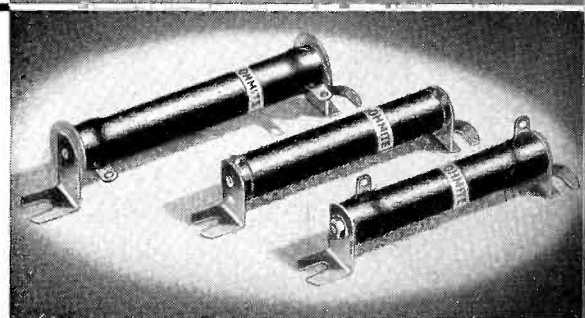

"CORRIB" TYPE

Has edge-wound, exposed corrugated ribbon winding. For low resistances where 100 watts or more must be dissipated in small space.

NON-INDUCTIVE TYPE

For radio frequency circuits where constant resistance and impedance are required. Made in vitreous enameled or sealed-in-glass types.

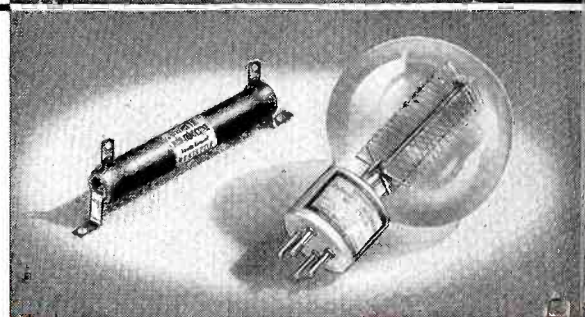

In addition to the many types of resistors shown above, Ohmite offers resistors in more than sixty different core sizes, and a wide range of wattages and resistance values. Ohmite engineers will be pleased to help you in selecting the right resistors for your needs.

OHMITE MANUFACTURING CO.

4817 Flournoy Street

Chicago 44, Illinois



Write on Company Letterhead for Catalog and Engineering Manual No. 40.

Contains 96 pages of useful data on the selection and application of rheostats, resistors, tap switches, and other equipment.



Be Right with ...

OHMITE

RHEOSTATS
RESISTORS
TAP SWITCHES

Industry's First Choice

PICK YOUR JINNI!

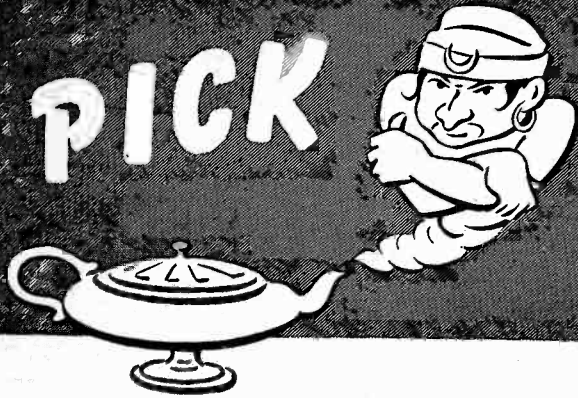

A POTTER ELECTRONIC COUNTER FOR EVERY

**timing
control
counting
sorting
totalizing**

NEED

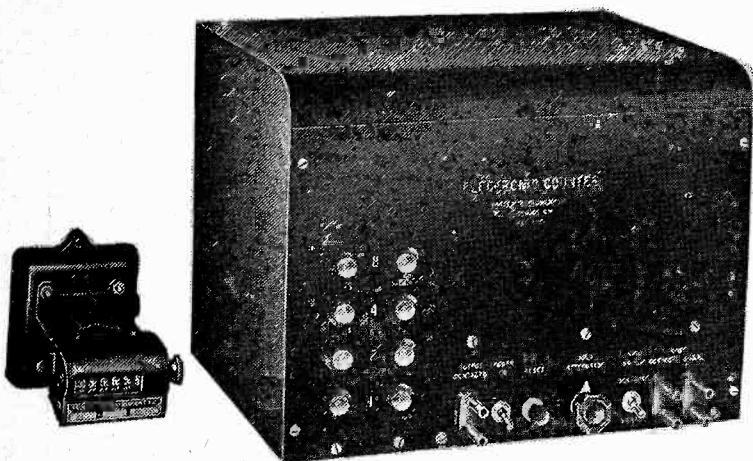

COUNTERS AND SCALERS

For straight high-speed counting and frequency dividing i.e. radiation counting-machine operations

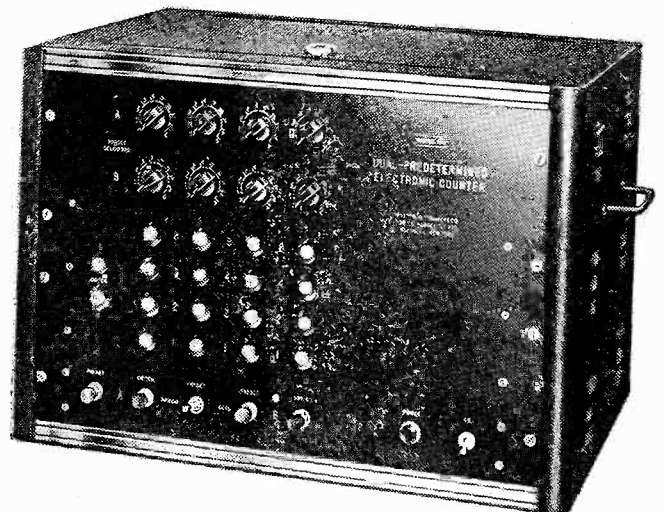

DUAL PREDETERMINED COUNTERS

For controlling two sequential operations at high rates i.e. zipper manufacture

SINGLE PREDETERMINED COUNTERS

For high speed counting and grouping of items for processing or packaging i.e. packaging of pills, buttons, hardware, etc.

CHECK THESE IMPORTANT FEATURES!

- **Speed and Accuracy**
Will count at rates up to a million per second with absolute accuracy.
- **Versatility**
Can be used for measurement and control of discrete quantities, length, area, time, velocity and frequency. Can also be used to totalize counts from several sources occurring simultaneously and at random.
- **Flexibility**
Readily substituted for slower inaccurate mechanical controls—adaptable to all types of input actuations. —Selection of any predetermined count made simply by dial switches. Easy to install and operate.
- **Reliability**
Sturdy construction using simple straight forward reliable circuits and high quality components. Assures maximum trouble free continuous operation. —No moving parts to wear out—

If you have a specific application problem or wish additional information on Potter Electronic Counter Circuits, write Potter Instrument Company, Dept. 6A,

Photoelectric Screen for gating interval timer in projectile velocity measurements.

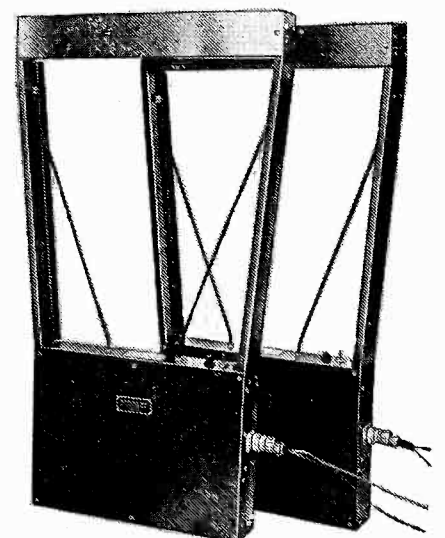
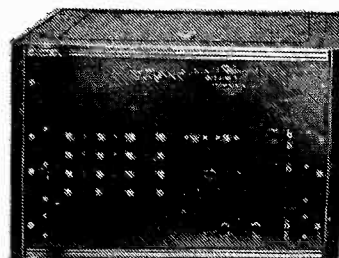

INTERVAL TIMERS

For measuring or predetermining intervals with micro-second accuracy i.e. projectile velocities—accurate time base generator.



POTTER INSTRUMENT COMPANY • 136-56 ROOSEVELT AVENUE • FLUSHING, N. Y.

VERSATILE
NEW LINE OF...

A·C AND D·C
RELAYS

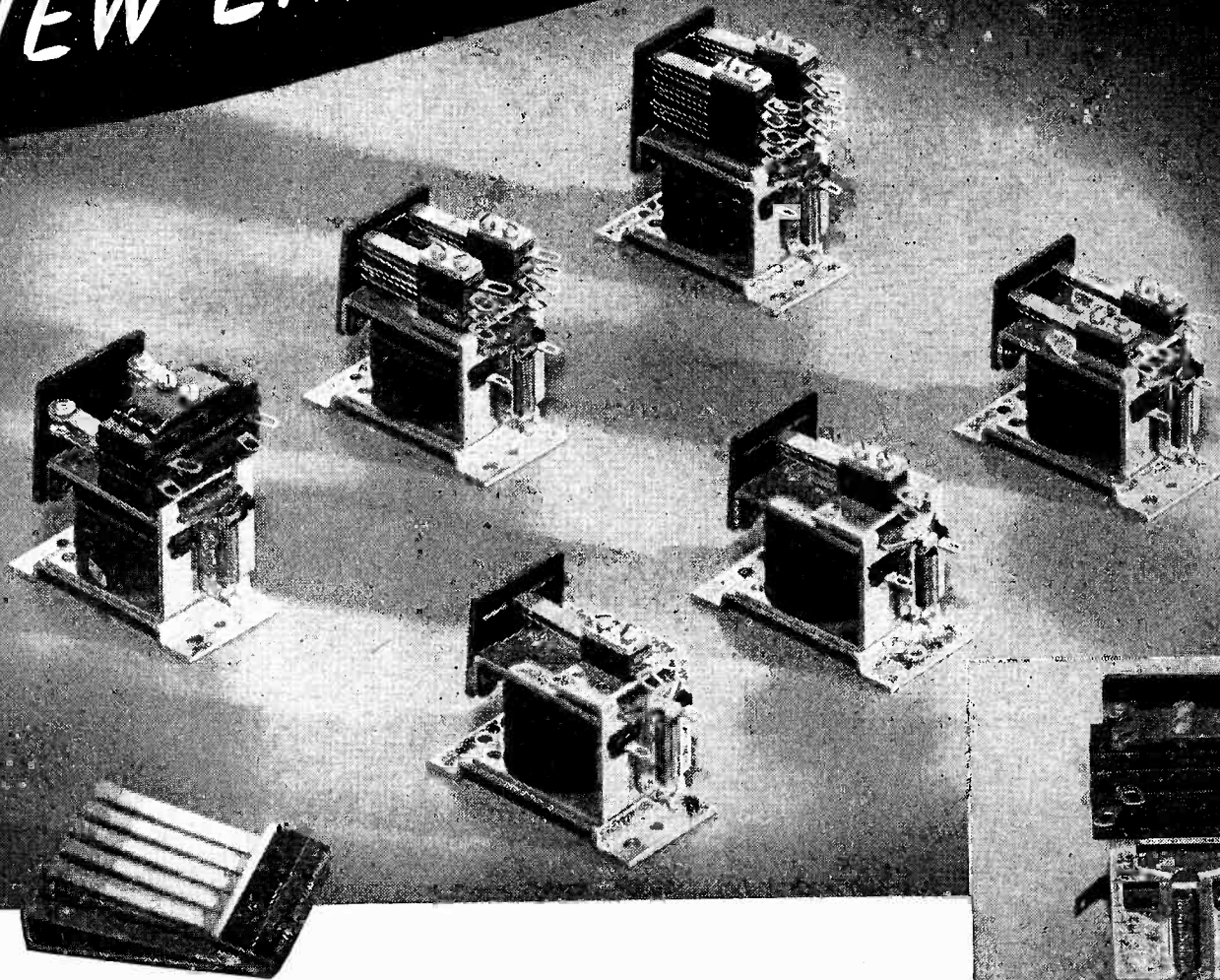

**EXCEPTIONALLY SMALL AND COMPACT
YET EXTREMELY RUGGED!**

● R-B-M announces a new line of general purpose magnetic relays, with either A.C. or D.C. shunt coils or series coils, for electronic applications.

Relays are available in standard contact arrangement of single and two pole normally open, normally closed; or double throw with light and heavy contacts. Four and six pole double throw relays are available with 3 ampere contacts at 32 volts or less.

Insert shows two pole, double throw contactor rated 13 amperes, 115 volts, A.C., and 6.5 amperes at 230 volts, A.C. This relay is designed in accordance with Underwriters' specifications and will ultimately carry Underwriters' Approval for Small Devices classification.

For further information write for Bulletin 570. Address Department A-4...

R-B-M DIVISION
ESSEX WIRE CORPORATION
Logansport, Indiana

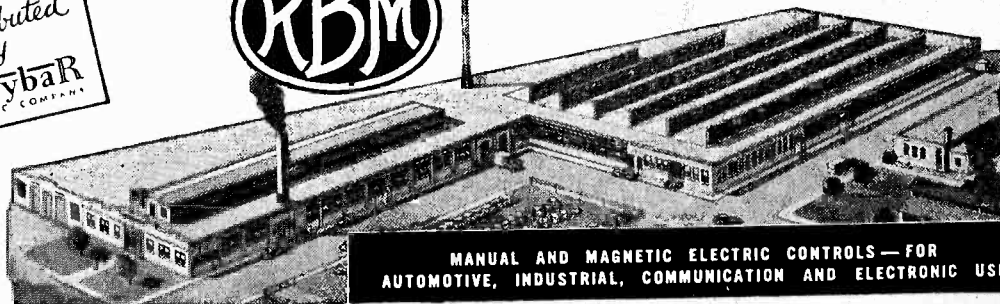
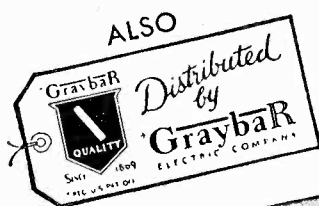

MANUAL AND MAGNETIC ELECTRIC CONTROLS — FOR
AUTOMOTIVE, INDUSTRIAL, COMMUNICATION AND ELECTRONIC USE

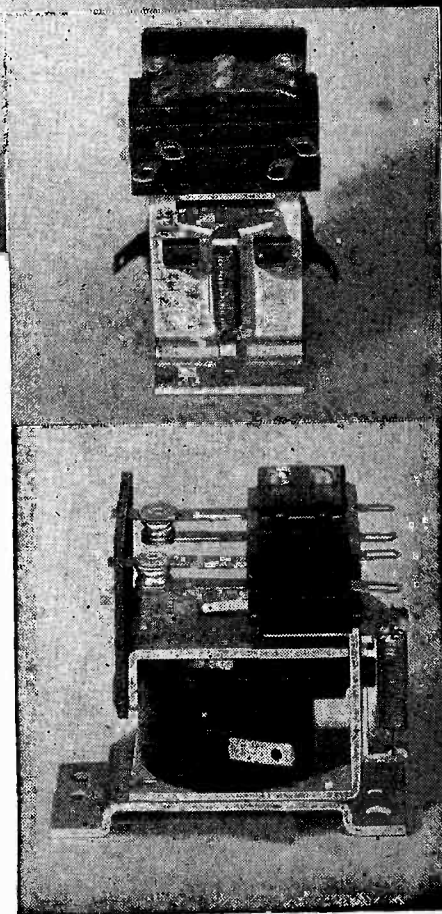

ALSiMAG INSULATION

TRADE MARK

FOR ELECTRONIC HEATING DEVICES

LOW LOSS FACTOR . . . HIGH DIELECTRIC STRENGTH AND RESISTIVITY

Electronic heating devices require the best insulation. That is why you find ALSiMag custom made technical ceramic insulation at the critical points in practically all the leading makes of dielectric

and induction heating equipment. ALSiMag is also widely employed in work holders, fixtures, gang run devices, locators, spacers and jigs to hold products during electronic heating.

AMERICAN LAVA CORPORATION
 CHATTANOOGA 5, TENNESSEE
 46th YEAR OF CERAMIC LEADERSHIP

SALES OFFICES: ST LOUIS, Mo., 1123 Washington Ave., Tel: Garfield 4959 • NEWARK, N. J., 671 Broad St., Tel: Mitchell 2-8159
 CAMBRIDGE, Mass., 38-B Brattle St., Tel: Kirkland 4498 • CHICAGO, 9 S. Clinton St., Tel: Central 1721 • SAN FRANCISCO,
 163 Second St., Tel: Douglas 2464 • LOS ANGELES, 324 N. San Pedro St., Tel: Mutual 9076 • PHILADELPHIA, 1649 N. Broad Street

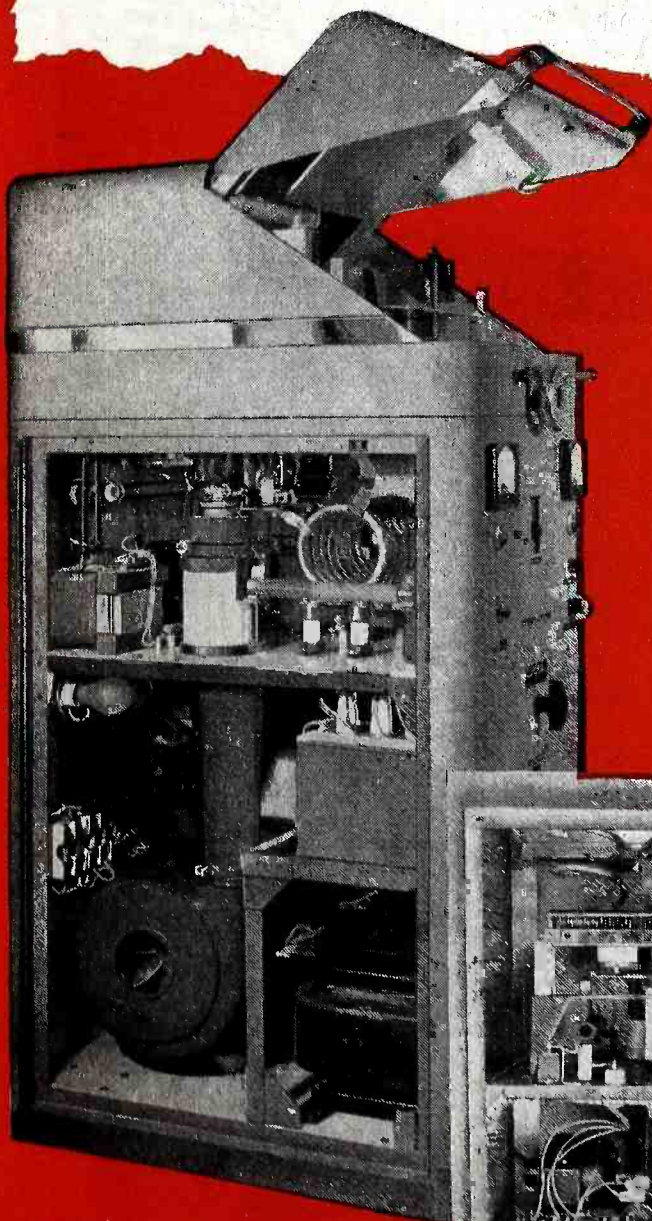

Right side view (Panel removed)
 5 KW Thermatron Heatmaster

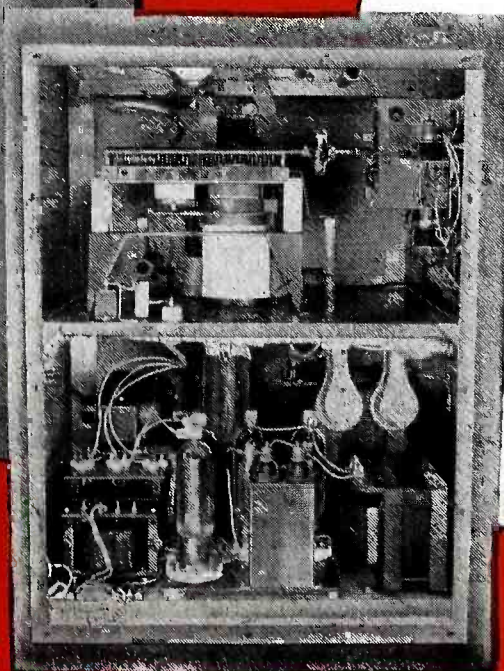

Left side view (Panel removed)
 25 KW Thermatron Heatmaster Jr.

**WHY
 THERMATRON
 USES ALSiMAG
 INSULATION**

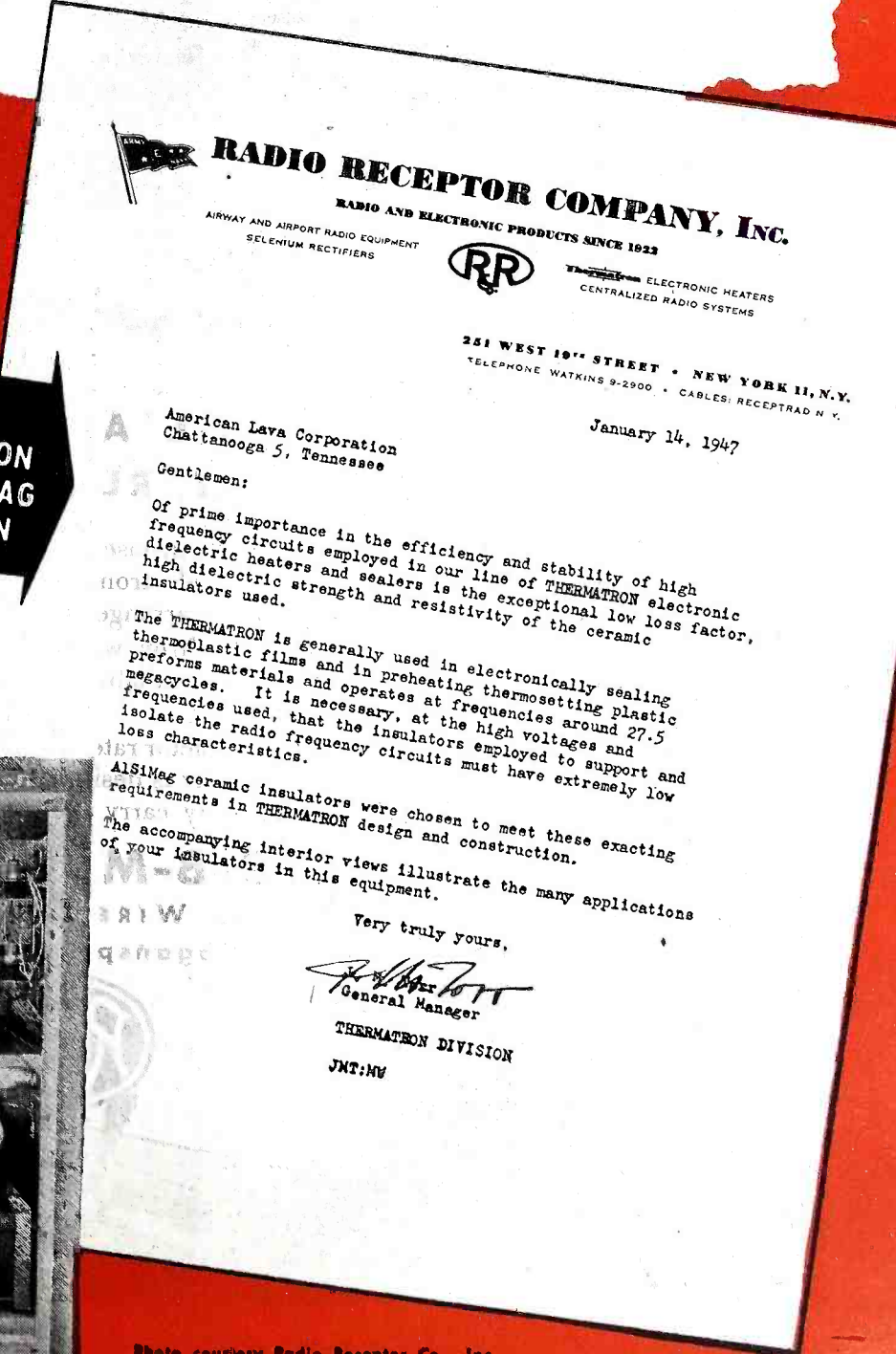

RADIO RECEPTOR COMPANY, INC.
 RADIO AND ELECTRONIC PRODUCTS SINCE 1923

AIRWAY AND AIRPORT RADIO EQUIPMENT
 SELENIUM RECTIFIERS
 ELECTRONIC HEATERS
 CENTRALIZED RADIO SYSTEMS



251 WEST 19th STREET • NEW YORK 11, N.Y.
 TELEPHONE WATKINS 9-2900 • CABLES: RECEPTAD N.Y.

January 14, 1947

American Lava Corporation
 Chattanooga 5, Tennessee

Gentlemen:

Of prime importance in the efficiency and stability of high frequency circuits employed in our line of THERMATRON electronic dielectric heaters and sealers is the exceptional low loss factor, high dielectric strength and resistivity of the ceramic insulators used.

The THERMATRON is generally used in electronically sealing thermoplastic films and in preheating thermosetting plastic preforms materials and operates at frequencies around 27.5 megacycles. It is necessary, at the high voltages and frequencies used, that the insulators employed to support and isolate the radio frequency circuits must have extremely low loss characteristics.

ALSiMag ceramic insulators were chosen to meet these exacting requirements in THERMATRON design and construction. The accompanying interior views illustrate the many applications of your insulators in this equipment.

Very truly yours,

[Signature]
 General Manager

THERMATRON DIVISION
 JMT:NV

Photo courtesy Radio Receptor Co., Inc.
 251 West 19th Street, New York 11, N. Y.

Now

**MORE ACCURATE FM-AM
RECEIVER TUNING BY MEANS OF
KEN-RAD'S REVOLUTIONARY NEW TUBE!**

THE 6AL7-GT ELECTRON-RAY INDICATOR TUBE



General Electric research, plus Ken-Rad development work, are responsible for the brilliant new 6AL7-GT indicator tube—most modern step in the direction of fast, accurate receiver tuning, FM and AM.

An electron-ray tube, twin light patterns appear on a fluorescent screen at the end of the glass bulb. These take the form of green bands which vary in depth according to changing voltages brought about in the process of tuning.

Extremely close FM discriminator tuning may be accomplished by matching depths of the 6AL7-GT's light patterns. How the patterns appear to the eye under various off-channel, on-channel, off-tune, and on-tune conditions, is diagrammed below. Three FM circuit applications are shown. A fourth—AM—illustrates how avc voltage may be used for tuning purposes by

CONTROL VOLTAGE SOURCE	SIGNAL	OFF CHANNEL (-)	ON CHANNEL OFF TUNE (-)	ON TUNE	ON CHANNEL OFF TUNE (+)	OFF CHANNEL (+)
DISCRIMINATOR	FM					
DISCRIMINATOR AND SQUELCH	FM					
DISCRIMINATOR AND LIMITER	FM					
AVC	AM					

New

IN PRINCIPLE IN SIMPLICITY AND RELIABILITY!

checking the depth of the two light patterns working as a unit.

Easy to see and read... Previous indicator tubes, developed for AM, have had reflecting targets, giving poor visibility because cathode and deflecting plates were placed in front of the screen, making it necessary to mask out the center. The fluorescent screen of the new Ken-Rad FM-AM 6AL7-GT is transparent, with electron-ray mechanism located *behind*, not before the image, thus offering no obstacle to vision.

Ken-Rad is consistently ahead with new tube developments—meaning that Ken-Rad dealers, and servicemen installing Ken-Rad tubes, march in the van of radio progress. Pioneering work by Ken-Rad, as typified by this great new 6AL7-GT indicator tube, enables you to serve *all* your clients better, whether their radio sets be AM or FM, old-style or new, portables or console models. . . . Install Ken-Rad tubes for greater owner satisfaction, and resulting bigger profits!

KEN-RAD'S OUTSTANDING NEW INDICATOR TUBE WILL BE ON VIEW AT THE CHICAGO PARTS SHOW, MAY 13 THROUGH 16. SEE HOW IT TUNES CIRCUITS TO HAIRLINE ACCURACY WITH EASE AND PRECISION! YOUR VISIT TO THE KEN-RAD DISPLAY WILL BE ONE OF THE HIGHLIGHTS OF YOUR CHICAGO TRIP. A CORDIAL WELCOME AWAITS YOU!

● The 6AL7-GT's principle of operation is unique and effective. In the cutaway drawing at the right, note that the three deflection electrodes are close to the cathode, with this whole assembly in turn separated from the target by the grid. The latter operates either at cathode potential, or at a few volts negative with respect to the cathode. Because electrons move slowly in the area between cathode and grid, the 6AL7-GT's deflectors easily control the position of the electron beams on the target. Increasing the negative voltage on the grid slows down the electrons still more, augmenting their response to the deflectors' pull and thus heightening the tube's sensitivity.

More detailed technical information and performance data on the 6AL7-GT will be furnished promptly on request. If you manufacture electronic equipment, Ken-Rad tube engineers gladly will work with you to apply the new Indicator Tube to radio receivers or test equipment you may have on your drawing-boards. Communicate direct with Ken-Rad at the address below.

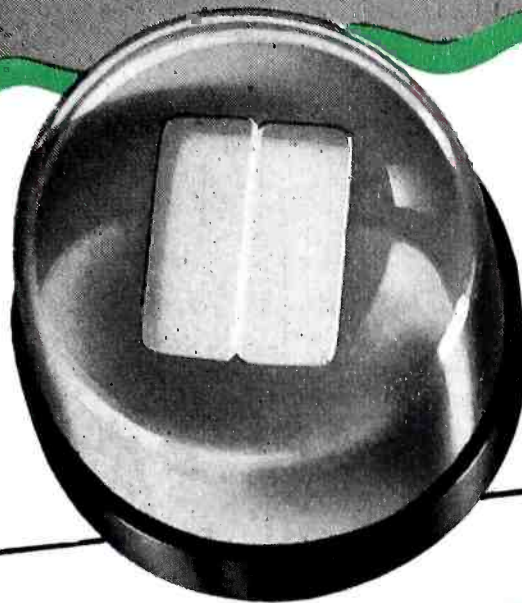

TYPICAL OPERATING CONDITIONS (Indicator service)

Heater voltage	6.3 v
Heater current	0.150 amp
Target voltage	315 v
Voltage, deflection electrodes 1, 2 and 3	0 v
Cathode resistor (approx)	3,300 ohms
Deflector sensitivity (approx)	1.0 mm/v
Fluorescence cut-off, grid volts (approx)	-6.0 v

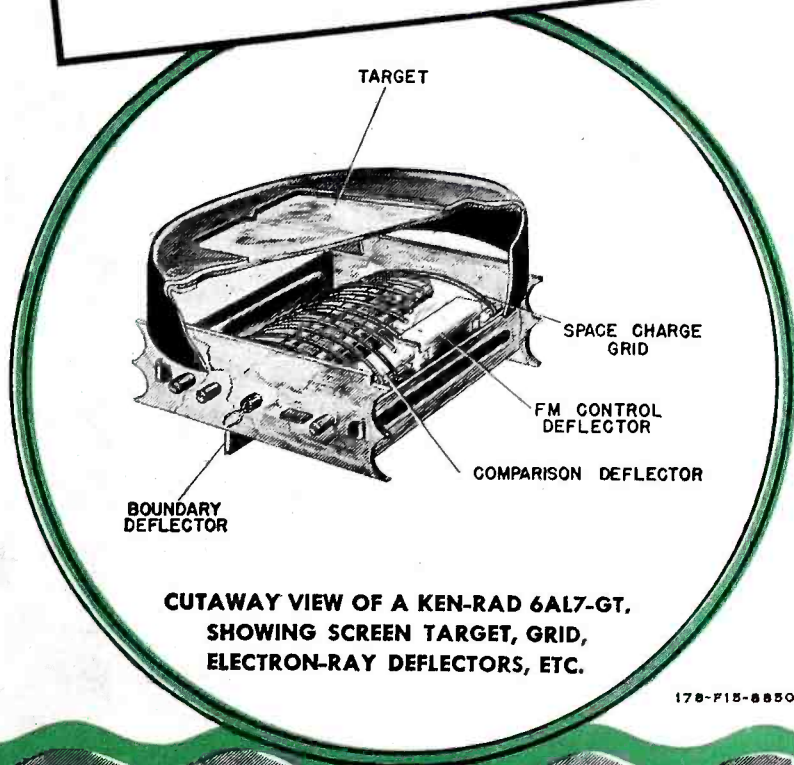

CUTAWAY VIEW OF A KEN-RAD 6AL7-GT, SHOWING SCREEN TARGET, GRID, ELECTRON-RAY DEFLECTORS, ETC.

178-715-8850

Behind KEN-RAD radio tubes stands Electronics' first and greatest name — GENERAL ELECTRIC

KEN-RAD

DIVISION OF
GENERAL ELECTRIC
COMPANY
SCHENECTADY,
NEW YORK

READY NOW

IN ANSWER TO HAMS' DEMANDS



Hams around the world have been National's collaborators in creating the NC-173—ready now after five years of intensive research. Here are some of the advantages this 13-tube superheterodyne receiver offers:

- The NC-173's newly designed adjustable threshold double diode noise limiter—working on both *phone and CW*—has an extremely high limiting efficiency because of the short recovery time.
- Voltage regulated circuits give the NC-173 high stability and less drift for changes in powerline voltage. The pitch of code characters barely changes—even over extended listening periods.
- The S-meter circuit allows signal strength recordings to be taken on either *phone or code*.
- Works equally well on coaxial feed-line, single-wire, directional or balanced antenna.
- AC powered. Will also operate on battery for portable or emergency use—110/120 or 220/240 volts, 50/60 cycle. Frequency range .54 to 31 and 48 to 56 MC. (Includes calibrated band spread on 5, 10, 11, 20, 40 and 80 meters).
- Ask your dealer to let you see and hear the new moderate-priced NC-173.

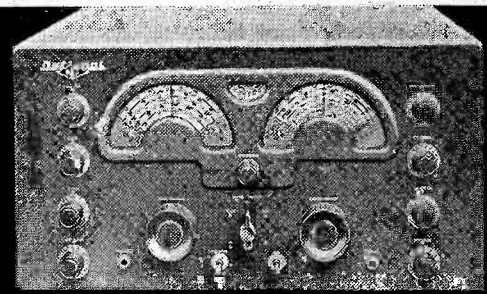
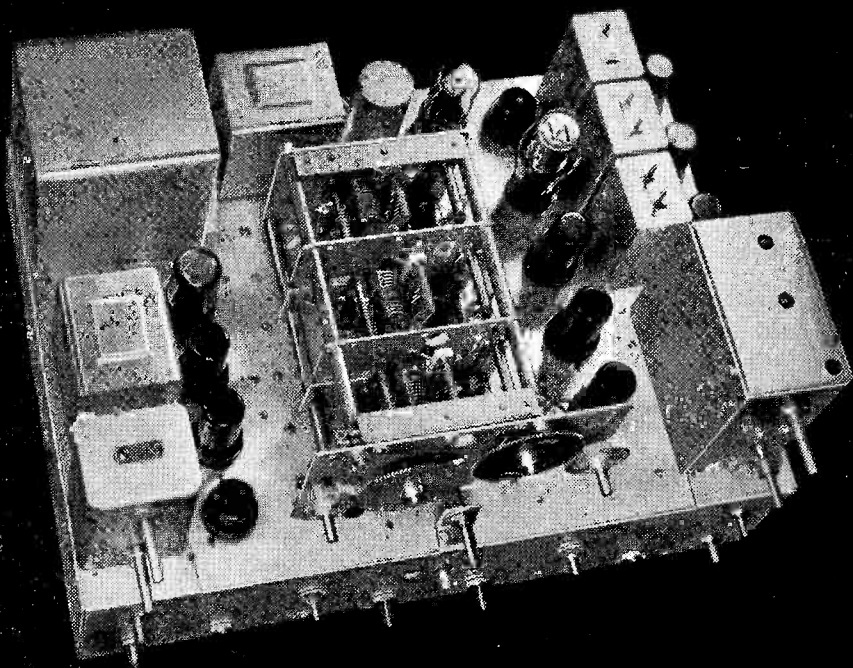

THE NATIONAL NC-173

NATIONAL
COMPANY, INCORPORATED
MALDEN, MASS.

THE MOST DISTINCTIVE NAME IN RADIO COMMUNICATIONS

Remove obstacles

like these...



Have you a problem which graphite in a liquid carrier can solve? "dag" colloidal graphite dispersed in many liquids has offered novel solutions to many vexing problems for scores of industries.

You know many of "dag" colloidal graphite's successful applications, but you will discover other equally helpful applications by reading the booklets listed below. Acheson Colloids Corporation's technical research and advisory service is continuously studying industrial problems and developing new uses of "dag" colloidal graphite to remove these problems. Return the coupon and find out how you can satisfactorily deal with your problems.

ACHESON COLLOIDS CORPORATION, PORT HURON, MICHIGAN

This new literature on "dag" colloidal graphite is yours for the asking:

- 460** A data and reference booklet regarding "dag" colloidal graphite dispersions and their applications. 16 pages profusely illustrated.
- 421** Facts about "dag" colloidal graphite for ASSEMBLING AND RUNNING-IN ENGINES AND MACHINERY.
- 422** Facts about "dag" colloidal graphite as a PARTING COMPOUND.
- 423** Facts about "dag" colloidal graphite as a HIGH TEMPERATURE LUBRICANT.
- 431** Facts about "dag" colloidal graphite for IMPREGNATION AND SURFACE COATINGS.
- 432** Facts about "dag" colloidal graphite in the FIELD OF ELECTRONICS.



ACHESON COLLOIDS CORPORATION
PORT HURON, MICHIGAN DEPT. D-5

JMLcoA-D-1

Please send me without obligation, a copy of each of the bulletins checked:

NAME _____

POSITION _____

FIRM _____

ADDRESS _____

ZONE No. _____ STATE _____

OUR PRESENT OIL SUPPLIER IS _____

(Lubricants containing "dag" colloidal graphite are available from major oil companies.)

NOW!

a complete line of
EJECT-O-MATIC
 automatic-feed
 soldering irons
 and accessories

The manufacturers of Eject-O-Matic—the only soldering iron with built-in automatic-feed—are now ready with a complete line of automatic-feed soldering irons, tips and accessories. Shown here are some of the items now available. All Eject-O-Matic irons are equipped with Multi-clad 400 hour tips, that last 50 to 75 times longer than the ordinary soldering tip. Safety base, for holding idle iron, is included with every Eject-O-Matic.

TIPS: multi-clad tips are available in eight different sizes and shapes.

SPECIAL TIPS CAN BE DESIGNED FOR YOUR PARTICULAR NEEDS—MINIMUM OF TEN.

Send today for new catalog

AUTOMATIC FEED SOLDERING IRON
EJECT-O-MATIC
 HOUSES · MEASURES · EJECTS THE SOLDER

MULTI-PRODUCTS TOOL COMPANY • 123 SUSSEX AVENUE • NEWARK, NEW JERSEY

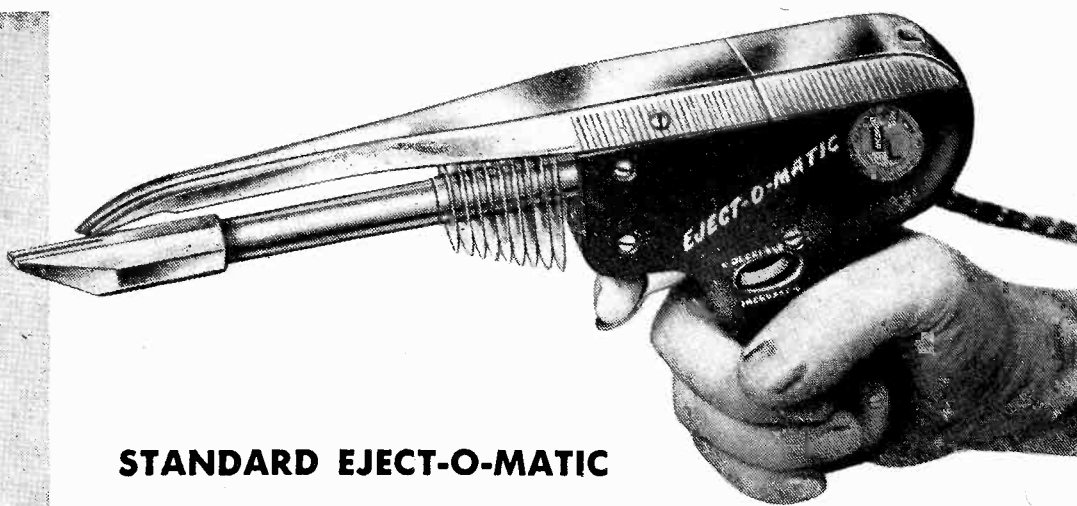

STANDARD EJECT-O-MATIC

The popular 50 and 75-watt models for general radio and electrical use. Weight only 18 oz. Special long-nosed models are also available in the same wattages, for soldering inside deep receptacles, hard-to-get-at relays and assemblies.

HEAVY DUTY EJECT-O-MATIC

High-heat 100 and 150-watt models for automotive, heavy electrical, sheet metal, and fill-in work, sealing cans, soldering heavy wire joints, and for general repair work. Weight only 22 oz.

Available also in the long-nosed instrument model.

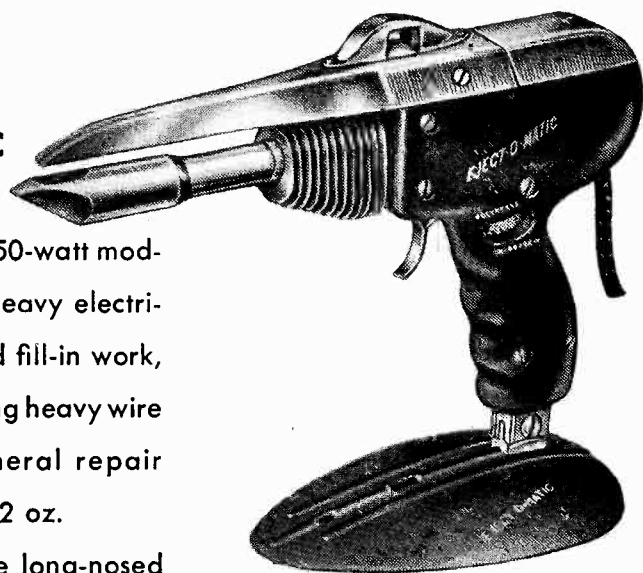

VERTI-MOUNT

The newest accessory in the Eject-O-Matic line! Made for high-speed, production-line soldering. The Verti-Mount takes all Eject-O-Matic irons. Treadle operated—leaves both hands free to hold work. Pre-heats and solders work with one easy foot movement. And the Eject-O-Matic can be mounted or dismounted in seconds.

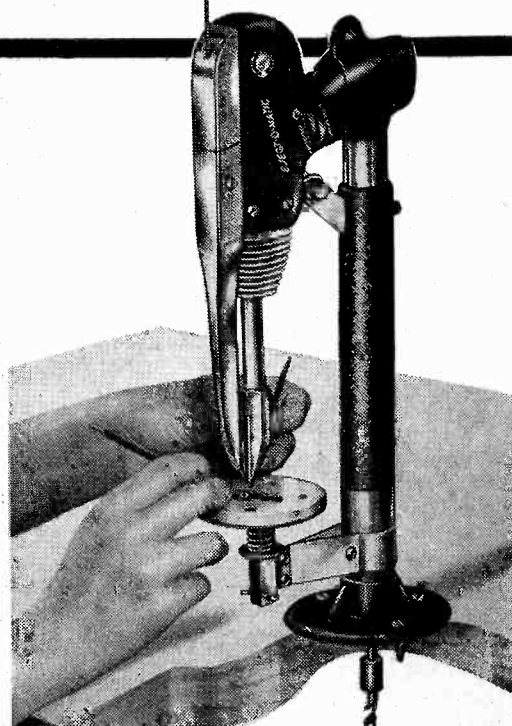

Specified Tolerance \pm *, Test Accuracy \pm ?

It is comparatively easy to lay down close tolerance specifications for springs. But can you tell you are getting them?

Strange as it may seem, springs are often ordered to tolerances beyond the purchaser's capacity or means for inspection.

Certain types of inspection equipment are accurate but not nearly fast enough for checking large quantities of springs. Others are *neither* fast nor accurate. And it is a matter of record that some

plants use equipment which has all the appearance, the sensitivity and the speed of fish scales . . . and old-fashioned fish scales at that.

If you must insist on springs with close tolerances, make sure you provide your inspectors with equipment for testing them quickly and adequately. Or order springs from Hunter where you get the tolerance you pay for . . . guaranteed by inspection devices of amazing accuracy and speed.

*Often next to nothing.

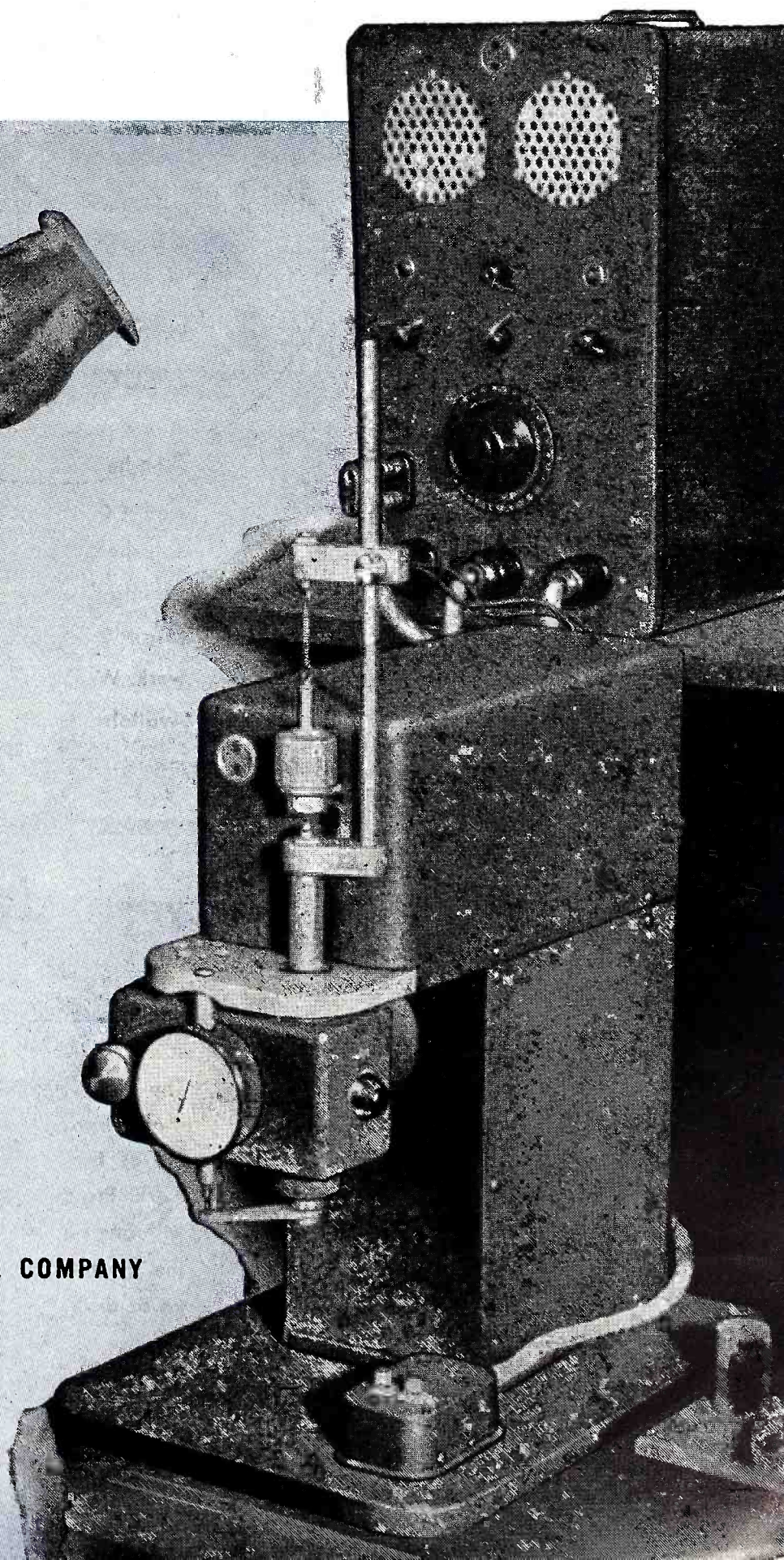
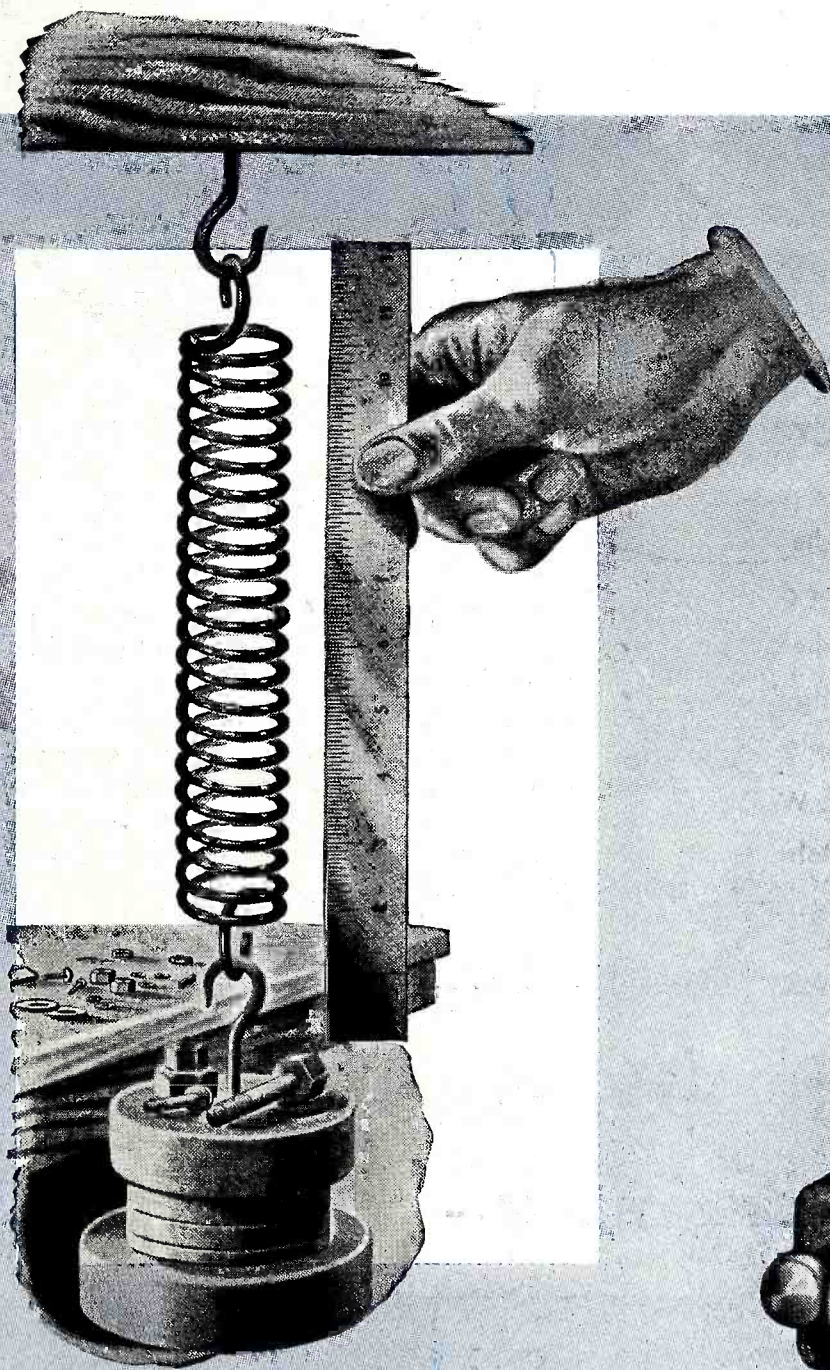

HUNTER PRESSED STEEL COMPANY
Lansdale, Pennsylvania

Springs, Metal Stampings, Wire Forms, Mechanical and Electrical Assemblies.

IT'S NEW...it's the...



Here's the new program console that will form the heart of a wired music distribution system, audition system, or control center for P.A. systems in schools, hospitals, factories and hotels.

It consists of the following completely packaged units, ready for plug-in operation with no additional wiring. Units may be obtained separately if desired:

ORIGINATING UNIT (left in above photograph)—equipped with a two-speed turntable, reproducer which plays both vertical and lateral recordings, equalizing transformer, pre-amplifier, main amplifier, repeating coils, and necessary controls.

CONNECTING UNIT (center)—provides desk space—includes a volume indicator and an electric clock. (Volume indicator and clock are included with the Originating Unit when it is ordered separately).

SUPPLEMENTARY UNIT (right)—same as the Originating Unit, except that it does not contain a main amplifier or repeating coils.

This console may be ordered equipped for network operation—where all subscribers receive the same program—or for private line use where subscribers are given a choice or may make specific requests. For both network and private line operation, a number of standardized accessories, panels and bays are available. Ask your local Graybar representative for complete details or write Graybar Electric Co., 420 Lexington Avenue, New York 17, N. Y.

Western Electric

— QUALITY COUNTS —

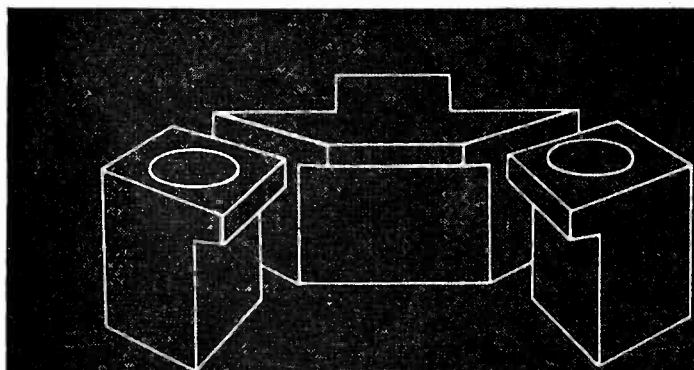
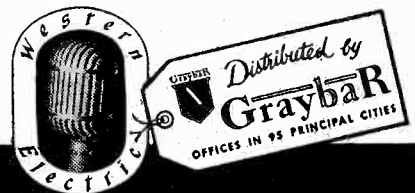

Units of console may be arranged to suit individual requirements. Here the Originating Unit and the Supplementary Unit are shown with and without Connecting Unit.

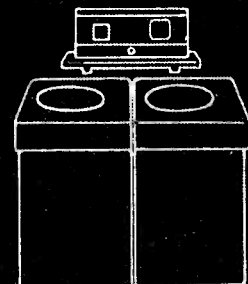

This Modern *Miracle* Clock keeps

In the Swing"

with

DRIVER-HARRIS

NILVAR*

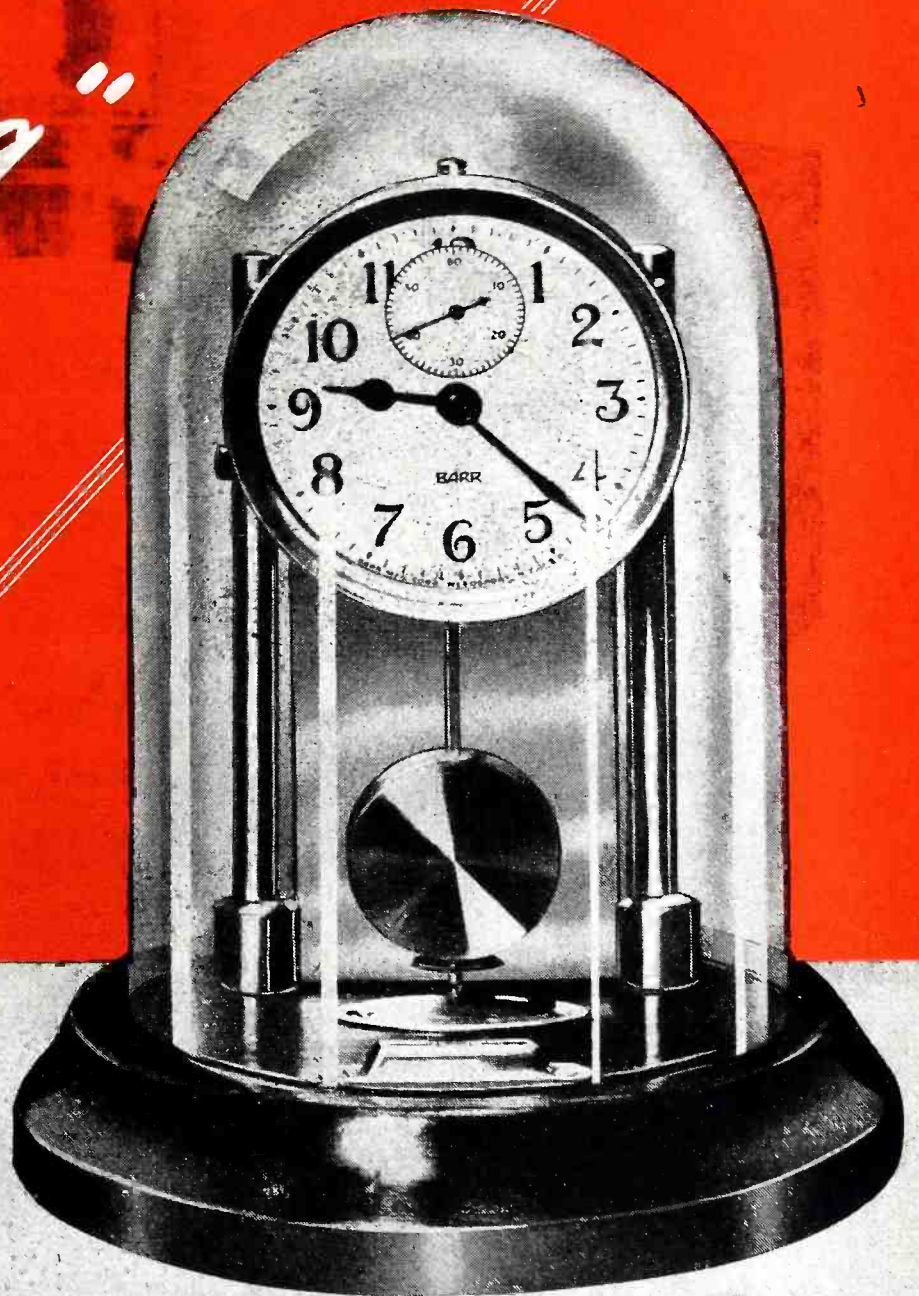

GRANDFATHER'S CLOCKMAKER didn't worry about the effect of temperature on the length and arc of a clock's pendulum — a minute lost or gained didn't matter. Today it does — and today we have the alloy Nilvar.

Nilvar is a remarkable alloy which has identical microscopic length at widely varying temperatures. For that reason, Barr Manufacturing Corporation selected it for the pendulum of its new "miracle" Executive Clock which depends for its accurate operation upon the unvarying characteristics of the pendulum arc — at any temperature.

This unusual clock provides synchronous motor accuracy, yet operates from a self-contained power supply. In operation, as the pendulum momentum gradually lessens, its arc decreases until,

at a pre-determined point a tiny weight is released which imparts fresh momentum to the pendulum. Thereupon the weight is instantly retrieved by a small-battery-energized electro magnet, in preparation for another cycle. No alloy but Nilvar could permit such critical pendulum arc control, for *Nilvar has the lowest T. C. of expansion of any alloy yet developed* — even lower than that of quartz.

Somewhere in your engineering or production operations — or in the operation of your product — the critical dimensional stability of Nilvar may help to solve a problem of long standing. Why not call on Driver-Harris engineers for their recommendations.



*Trade Mark
Reg. U.S. Pat. Off.

The B. GREENING WIRE COMPANY, LTD.
Hamilton, Ontario, Canada

Driver-Harris COMPANY

Exclusive Manufacturers of Nichrome
HARRISON, N. J.

BRANCHES: Chicago • Detroit • Cleveland • Los Angeles • San Francisco • Seattle

Where there is Horsepower—

There is Wire

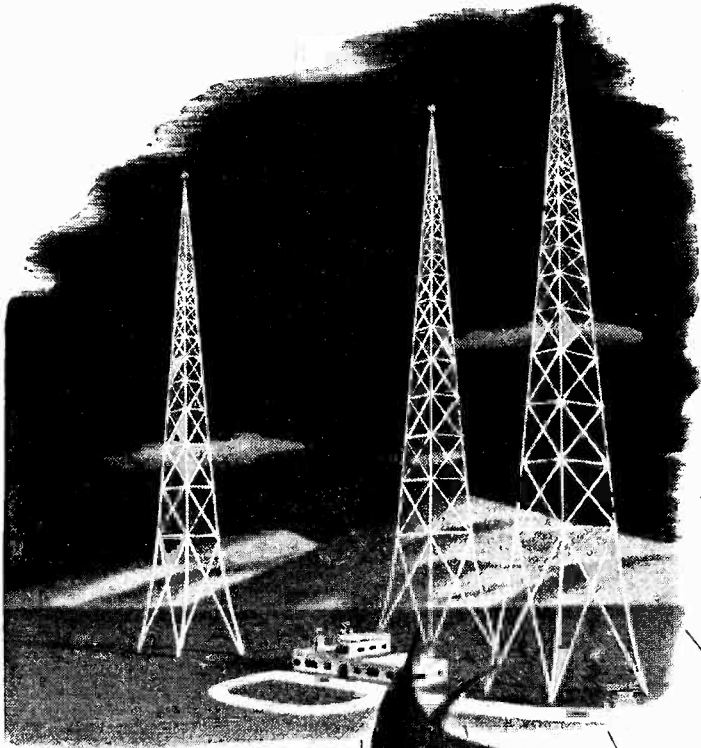

Man has always wanted news—and felt a frantic urge to “get the message through.” There were shouters on the hilltops—a runner to announce the Persian loss of Marathon. Then horses sped the mails; but they were yet too slow—too slow for instance to prevent a battle after the peace was signed.

The telephone was a novelty in 1902—when Belden Manufacturing Company was founded. The story of instantaneous communications reads on from there.

Words have conquered space and time—because the products of the wiremakers have harnessed horsepower.

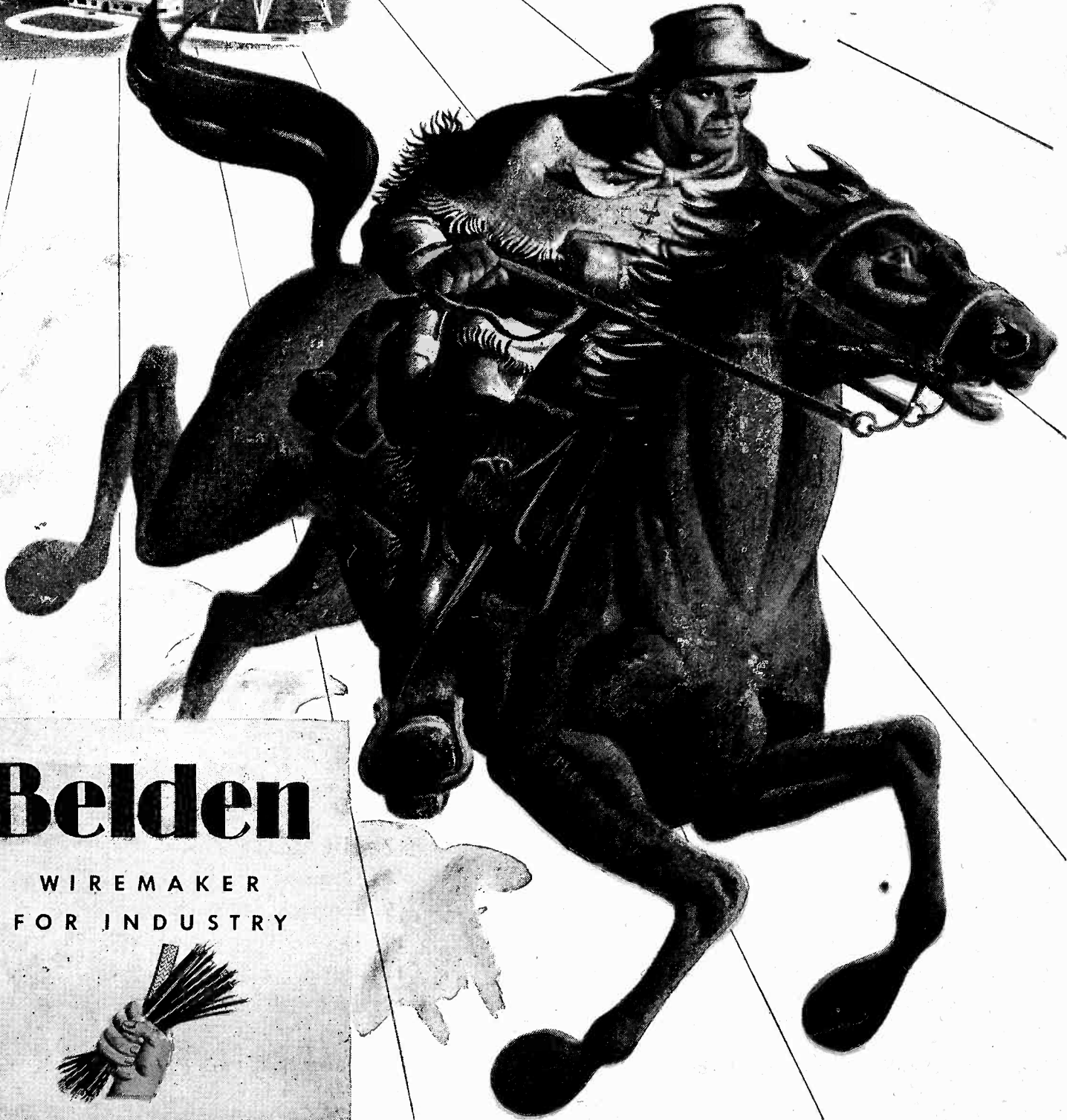

Belden

WIREMAKER
FOR INDUSTRY

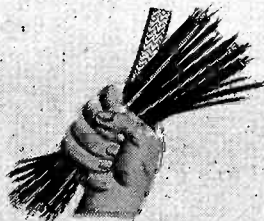

THIS PROVES IT!

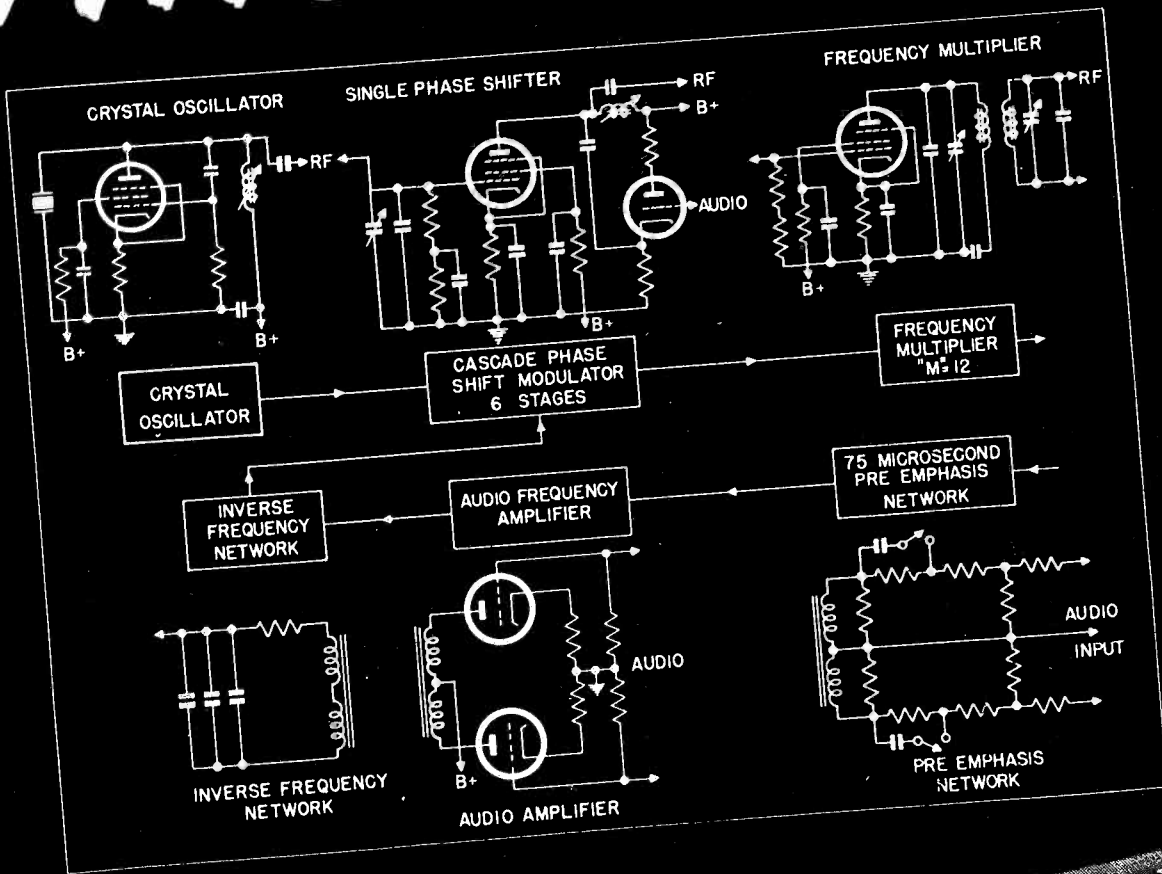

Cascade
**PHASE
 SHIFT
 MODULATION**

RAYTHEON FM

IS BETTER...

12 Ways



Excellence in Electronics

BECAUSE IT:

1. Features direct crystal control
2. Gives the most desirable electrical characteristics
3. Contains fewest circuits, fewest tubes
4. Has the simplest circuits
5. Is easiest to tune and maintain
6. Has *inherently* the lowest distortion level

AND ELIMINATES ALL:

7. High orders of multiplication
8. Complex circuits
9. Expensive special purpose tubes
10. Discriminator frequency control circuits
11. Pulse counting circuits for frequency control
12. Motor frequency stabilizing devices

See your consulting engineer and write for fully illustrated booklet giving complete technical data and information. Write today to:

RAYTHEON MANUFACTURING COMPANY

Broadcast Equipment Division, 7475 North Rogers Avenue, Chicago 26, Illinois

THIS TIME BOTH DAVID AND GOLIATH HAD TO WIN

In almost any business, how to handle both large and small orders with equal dispatch is a problem. At least that's the way it was in our industry (resistors) until January 1, 1946. On that day—after months of observation, we introduced the IRC Industrial Service Plan. Minimum orders for nearly all IRC Standard Resistors can now be obtained from the well-stocked shelves of local independent electronic parts distributors. No time lost when you need experimental or maintenance quantities in a hurry. No production runs held up by small orders at the factory. Consuming manufacturer, distributor and ultimate user all benefit.

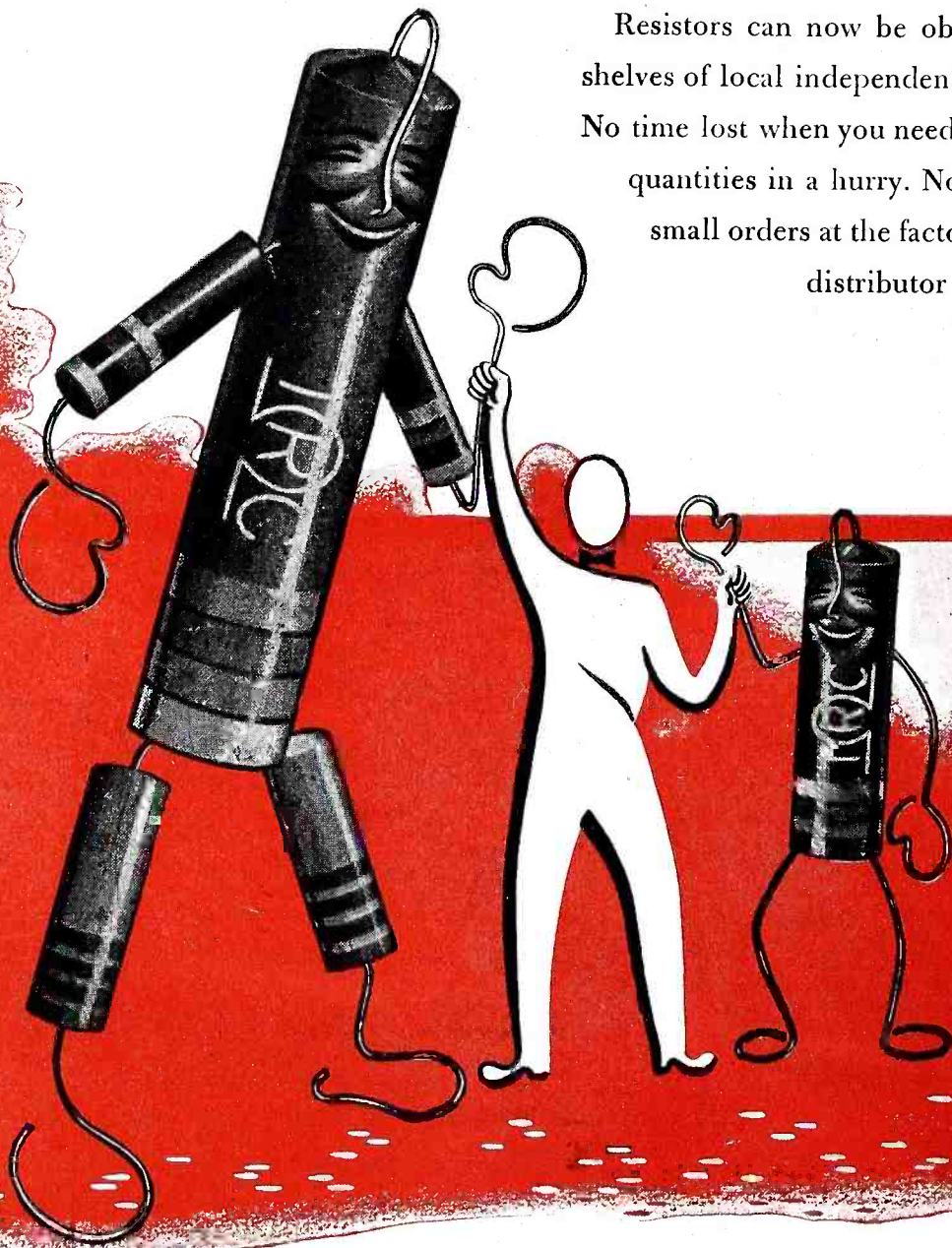

An unpretentious booklet containing the essence of the IRC Industrial Service Plan is available upon request.

IRC

Wherever the Circuit says Ω

Power Resistors on Short Delivery Cycle

Whatever your needs in power resistors there's an IRC resistor to do the job... readily available for immediate delivery. Four types of power wire wound resistors... each particularly suited to certain circuit or design applications... all unexcelled in essential electrical and mechanical characteristics... provide proven solutions to voltage dropping problems where power dissipation is necessary. Write for complete information regarding specifications, characteristics and delivery, stating products in which you are interested. International Resistance Company, 401 N. Broad Street, Philadelphia 8, Pennsylvania. In Canada: International Resistance Company, Ltd., Toronto, Licensee.

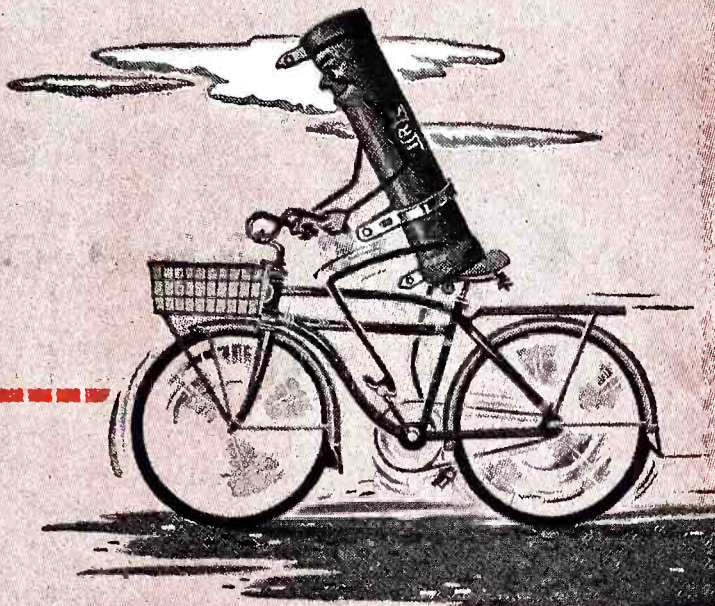

PWW Resistors

For exacting heavy-duty applications. Tubular power wire wounds of extreme mechanical strength. Available in two coatings for high temperature or high humidity conditions. Fixed, adjustable and non-inductive types in full range of sizes, ohmic values and terminals.



FRW Resistors

For voltage dropping in limited space applications. Flat power wire wounds of lightweight construction. Designed for vertical or horizontal mounting singly or in stacks. Mounting brackets serve as conductors of internal heat. Fixed adjustable and non-inductive types in full range of sizes and ohmic values.

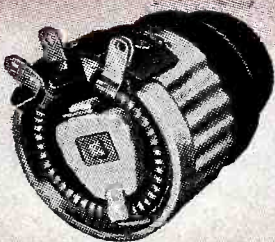

PR Rheostats

All metal construction permits operation at full load with as little as 25% of winding in use, with only slight increase in temperature rise. Available in 25 and 50 watt ratings. Type PR-25: diameter 1²³/₃₂"', depth behind panel 3¹/₃₂"', standard resistance values 1 to 5,000 ohms. Type PR-50: diameter 2²³/₃₂"', depth behind panel 1³/₈"', standard resistance values 0.5 to 10,000 ohms (higher values on special orders).

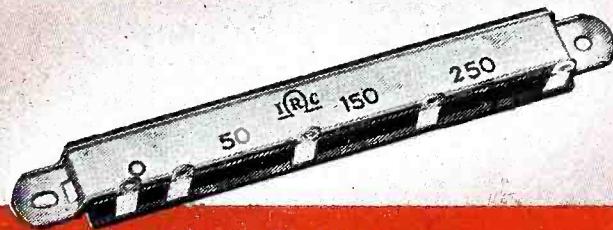

MW Resistors

For applications where low temperature rise, space and weight are vital factors. Encased in special phenolic compound for complete protection. Unique design of mounting bracket aids rapid heat dissipation. Multi-section feature permits exceptional flexibility for voltage dividing applications.

$$I = \frac{E}{IRC}$$

INTERNATIONAL RESISTANCE COMPANY

Power Resistors • Precisions • Insulated Composition Resistors • Low Wattage Wire Wounds • Rheostats • Controls • Voltmeter Multipliers • Voltage Dividers • HF and High Voltage Resistors

Exactly

THE RIGHT RELAY FOR YOUR APPLICATION

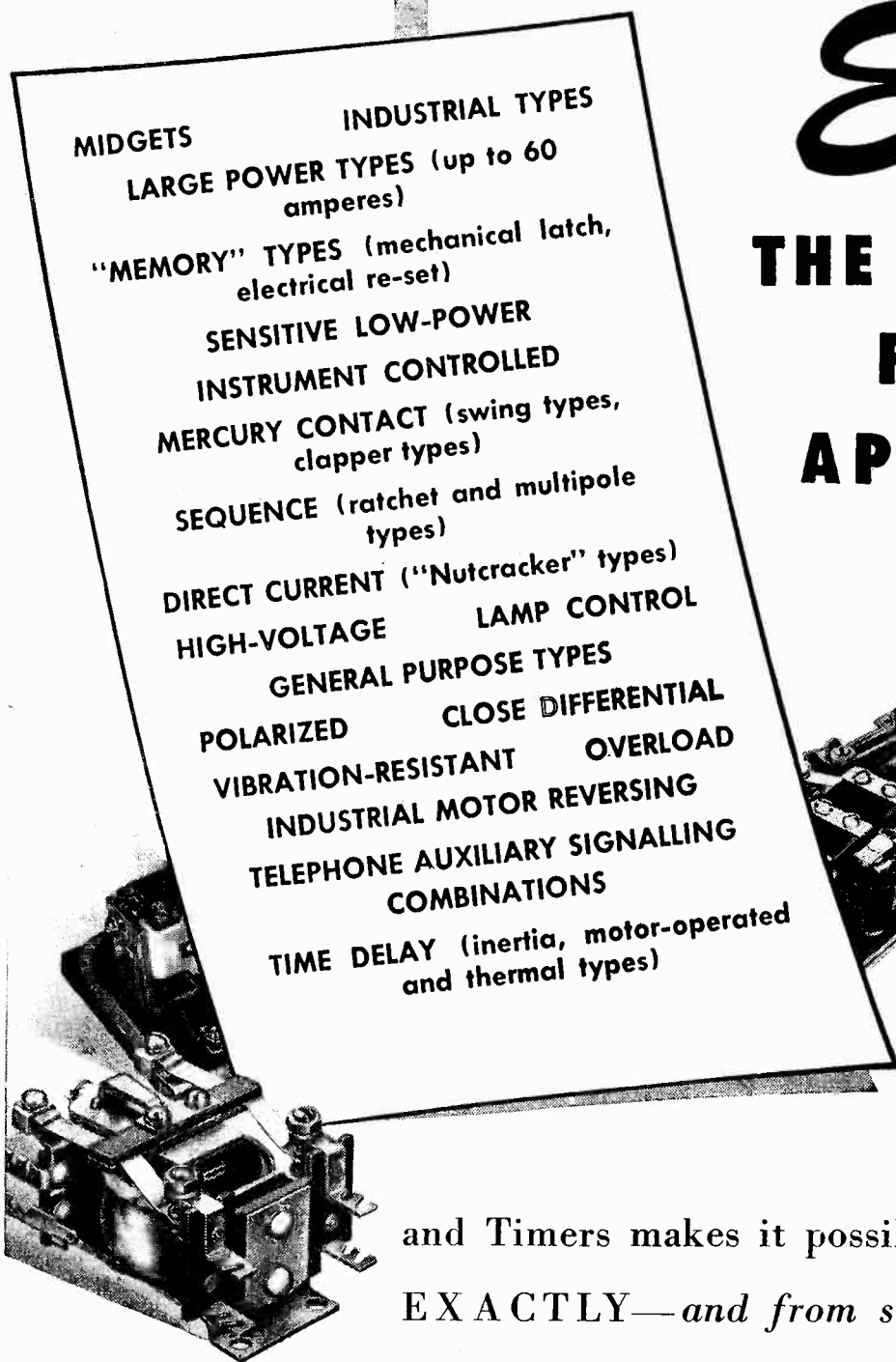
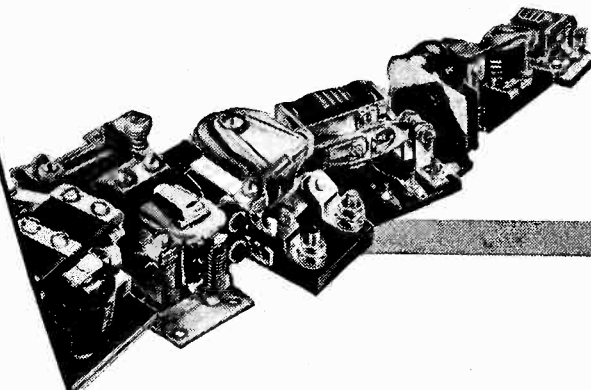

MIDGETS
INDUSTRIAL TYPES
LARGE POWER TYPES (up to 60 amperes)
"MEMORY" TYPES (mechanical latch, electrical re-set)
SENSITIVE LOW-POWER
INSTRUMENT CONTROLLED
MERCURY CONTACT (swing types, clapper types)
SEQUENCE (ratchet and multipole types)
DIRECT CURRENT ("Nutcracker" types)
HIGH-VOLTAGE LAMP CONTROL
GENERAL PURPOSE TYPES
POLARIZED CLOSE DIFFERENTIAL
VIBRATION-RESISTANT OVERLOAD
INDUSTRIAL MOTOR REVERSING
TELEPHONE AUXILIARY SIGNALLING
COMBINATIONS
TIME DELAY (inertia, motor-operated and thermal types)

The tremendous number
of Struthers-Dunn Relays

and Timers makes it possible to meet most specifications
EXACTLY—and from standard types. All are highly
adaptable as to contact, coil and mounting arrangements.

STRUTHERS-DUNN, INC. • 146-150 N. 13th ST., PHILADELPHIA 7, PA.

Write for Data Bulletin on any type

STRUTHERS-DUNN

ATLANTA • BALTIMORE • BOSTON • BUFFALO • CHICAGO • CINCINNATI • CLEVELAND • DALLAS
DENVER • DETROIT • HARTFORD • INDIANAPOLIS • LOS ANGELES • MINNEAPOLIS • MONTREAL
NEW YORK • PITTSBURGH • ST. LOUIS • SAN FRANCISCO • SEATTLE • SYRACUSE • TORONTO

1 MILLION

AIRLOOPS

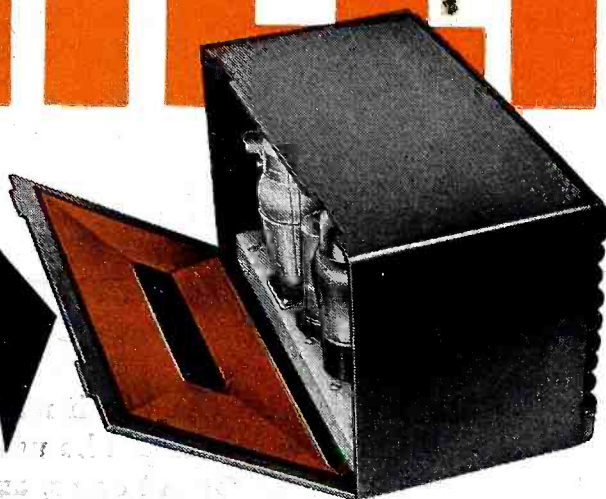

INSTALLED IN RADIO RECEIVERS IN LESS THAN A YEAR

**AIRLOOPS' . . . back panel and loop antenna in one unit*

It was less than a year ago that large scale production of **AIRLOOPS** began to feed radio set assembly lines and in this short time more than a million receivers, fitted with **AIRLOOPS**, went into service throughout the world.

The enthusiastic acclaim and acceptance of the **AIRLOOP** is well earned. It has dem-

onstrated that its many superior features improve set performance and lower the cost of radio assembly and manufacture. Time and use have proved the **AIRLOOP** the most significant post war development in radio components . . . no set builder can afford to overlook the values **AIRLOOPS** contribute to set performance .

FRANKLIN

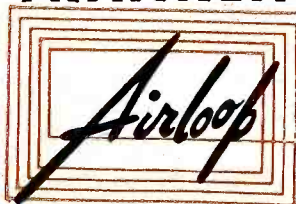

. flat sheets of copper die-stamped into perfect super sensitive loops . . . are air dielectric throughout . . . are lower in cost . . . are back panel and loop in one unit . . . have high uniform "Q" over entire band . . . have low distributed capacity . . . have 27% greater effective loop area . . . have electrical and mechanical stability . . . increase set sensitivity . . . eliminate individual loop adjustment . . . eliminate haywire.

FRANKLIN AIRLOOP CORPORATION
43-20 34th ST. LONG ISLAND CITY 1, N. Y.

If it's an Insulation Problem
 ... this is the name to know.

Continental Diamond
C - D
 Engineers & Non-Metallics

- When you are looking for better product performance . . . a greater margin of safety in electrical equipment—discuss it with C-D engineers. It is their application experience, coupled with C-D production "know-how", that has led to the development of the complete line of C-D Non-Metallics: molded macerated and laminated plastics, bonded mica and fibre products to meet the specific needs of industry.
- They can advise you which materials best meet high voltage requirements, which should be used for high frequencies, which for panels or instrument cases, as well as those best suited for thermal or moisture conditions.
- Take advantage of this specialized, practical experience and by-pass costly errors in your planning that may cause product failure. A call to our nearest office will find a ready, helpful response from C-D engineers.

C-D NON-METALLIC PRODUCTS

DILECTO—Thermosetting Laminated Plastics.

CELORON—A Molded Phenolic Plastic.

DILECTENE—A Pure Resin Plastic Especially Suited to U-H-F Insulation.

HAVEG—Plastic Chemical Equipment, Pipe, Valves and Fittings.

DIAMOND Vulcanized FIBRE.

VULCOID—Resin Impregnated Vulcanized Fibre.

MICABOND—Built-up Mica Electrical Insulation

Grade XXP natural paper base Dilecto was used for this electrical insulating strip. In addition to clean, easy fabrication, C-D Dilecto provides excellent mechanical and dielectric strength.

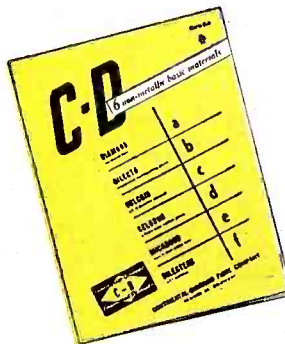

STANDARD & SPECIAL FORMS

Available in Standard Sheets, Rods and Tubes; and Parts Fabricated, Formed or Molded to Specifications.

DESCRIPTIVE LITERATURE

Bulletin GF gives Comprehensive Data on all C-D Products. Catalogs are also available.

D-2-47

BRANCH OFFICES: NEW YORK 17 • CLEVELAND 14 • CHICAGO 11 • SPARTANBURG, S. C. • SALES OFFICES IN PRINCIPAL CITIES
 WEST COAST REPRESENTATIVES: MARWOOD LTD., SAN FRANCISCO 3 • IN CANADA: DIAMOND STATE FIBRE CO., OF CANADA, LTD., TORONTO 8

Continental - Diamond FIBRE COMPANY

Established 1895..Manufacturers of Laminated Plastics since 1911—NEWARK 16 • DELAWARE

NEW 5516 INSTANT-HEATING VHF BEAM PENTODE

**18
WATTS**

**USEFUL POWER OUTPUT
FOR MOBILE F-M
WITHOUT NEUTRALIZATION**

**165
MC**



IT WAS NOT EASY . . . Compact though it is, the new 5516 is a far cry from the cathode-type tubes previously used in mobile vhf equipment. Design and production headaches for instant-heating vhf beam pentodes increase in geometric progression with the operating frequency. A glance at 5516 constructional advantages discloses unusual measures taken to solve such problems. Yes, the 5516 of necessity costs more, but it does a *real* job at 165 mc.

WHAT THE 5516 DOES FOR YOU . . . 5516 useful power outputs at 165 mc of 18 watts f-m, 12 watts a-m (more at lower frequencies) are not theoretical but are based on actual tested transmitter designs. Low internal tube drop gives high output at low plate potential, with simplified power supply requirements. Instant-heating filament permits tremendous savings in battery drain — mobile or aircraft. One 2E30 doubler or tripler drives a 5516 in plate-modulated class C to full output at 165 mc. Ratings — designed for mobile use — are CCS and equally suitable for the fixed station. Also the 5516 requires no neutralization in properly designed circuits. Write today for complete data sheet.

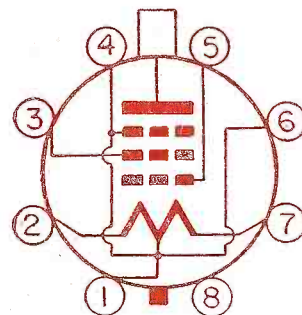

BASING — BOTTOM VIEW

Pin	Connection	Pin	Connection
1	Fil. center tap & beam plates	5	Control grid
2	Filament	6	Same as pin 1
3	Screen grid	7	Filament
4	Same as pin 1	8	No connection
			Cap Plate

HYTRON TYPE 5516
INSTANT-HEATING VHF BEAM PENTODE

GENERAL CHARACTERISTICS

Filament	oxide-coated, center-tapped		
Potential (a-c or d-c)	6.0 ± 10% volts		
Current	0.7 ampere		
Grid-plate capacitance	0.12 max. μf .		
Input capacitance	8.5 μf		
Output capacitance	6.5 μf		
Maximum overall length	3-21/32 inches		
Maximum diameter	1-7/16 inches		
Base	low-loss, medium-shell, 8-pin octal		

ABSOLUTE MAXIMUM CCS RATINGS

		Mod.*	Unmod:	
D-c plate potential	80 mc	475	600	v
	135 mc	395	500	v
	165 mc	355	450	v
D-c plate power input	80 mc	30	45	w
	135 mc	26.5	40	w
	165 mc	23.5	35	w
D-c plate current		75	90	ma
D-c screen potential		250	250	v
Plate dissipation		10	15	w

USEFUL POWER OUTPUT (CCS) — TYPICAL OPERATION#

Service	Up to:	165	135	80	mc
Class C unmod. or f-m	18	24	30		w
Class C plate-modulated	12	16	20		w

* Carrier condition with max. modulation percentage of 100. # Useful power output to load equals plate power output less circuit and direct radiation losses.

5516

CONSTRUCTIONAL ADVANTAGES

- Zirconium-coated plate, gold-plated control grid, carbonized screen grid enable maximum possible vhf ratings, despite compact size.
- Special, rugged filament suspension avoids short circuits and burn-outs in rigorous mobile applications.
- Three separate base-pin connections to filament center tap provide for lowest possible cathode lead inductance.
- Dishpan stem and compact structure give short, heavy leads with low inductance and capacitance.

SPECIALISTS IN RADIO RECEIVING TUBES SINCE 1921

HYTRON

RADIO AND ELECTRONICS CORP.



MAIN OFFICE: SALEM, MASSACHUSETTS

Reasons why...

The Trend is Toward ERIE "GP" CERAMICONS for By-Pass and Coupling Applications

ECONOMICAL

**REQUIRE
LESS SPACE**

**EXCELLENT
ELECTRICAL
PROPERTIES**

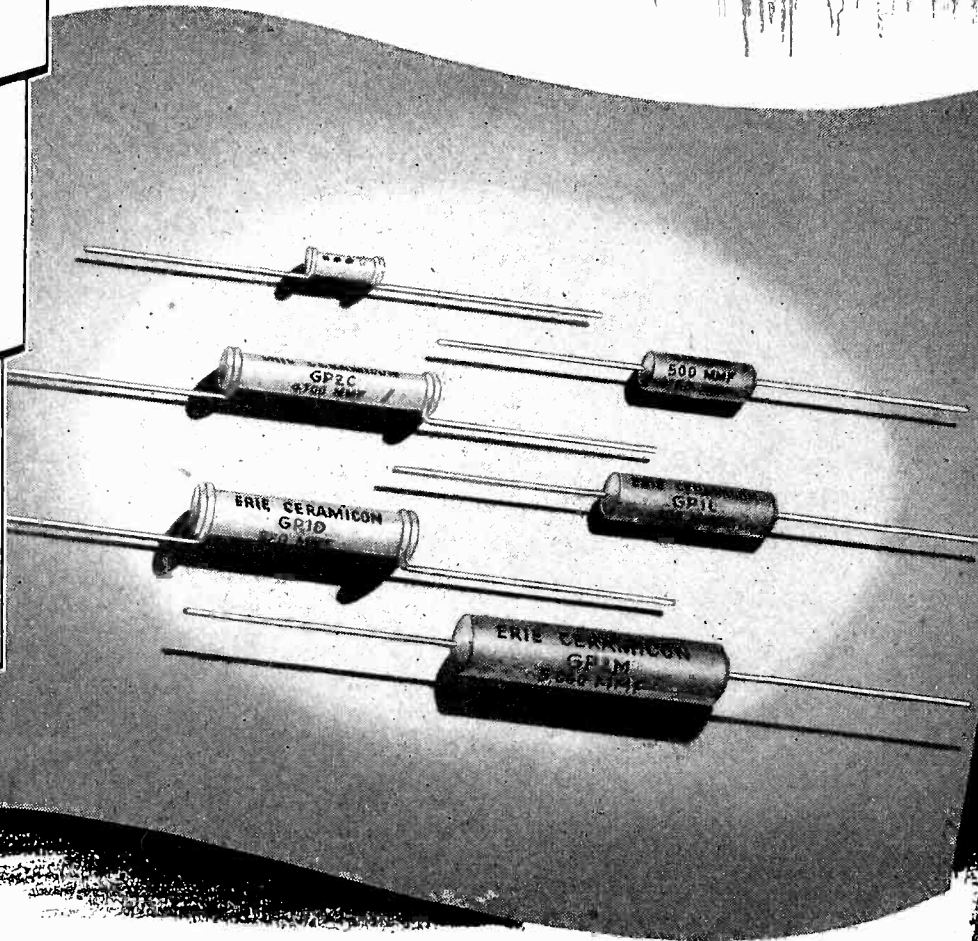

*M*ASS production methods in the manufacture of ERIE "GP" Ceramicons make possible mass production prices. Available in popular capacities, quantity production, with strict adherence to quality standards, bring new price economies in ceramic condensers for practically all applications in which the condenser is not directly frequency determining.

High capacities are available in extremely compact sizes. Because they are tubular in shape, they require less area than many types of rectangular shaped condensers of

equal capacities. Their physical characteristics make them easy to handle in the assembly line.

Because of their basic, simple construction ERIE "GP" Ceramicons have higher resonant frequencies. This factor is increasingly important as the higher frequencies used in FM & Television are reached.

The trend is toward ERIE "GP" Ceramicons. They are made in insulated styles in popular capacity values up to 5000 MMF, and in non-insulated styles up to 10,000 MMF. Write for full details and samples.



Electronics Division

ERIE RESISTOR CORP., ERIE, PA.

LONDON, ENGLAND • • TORONTO, CANADA

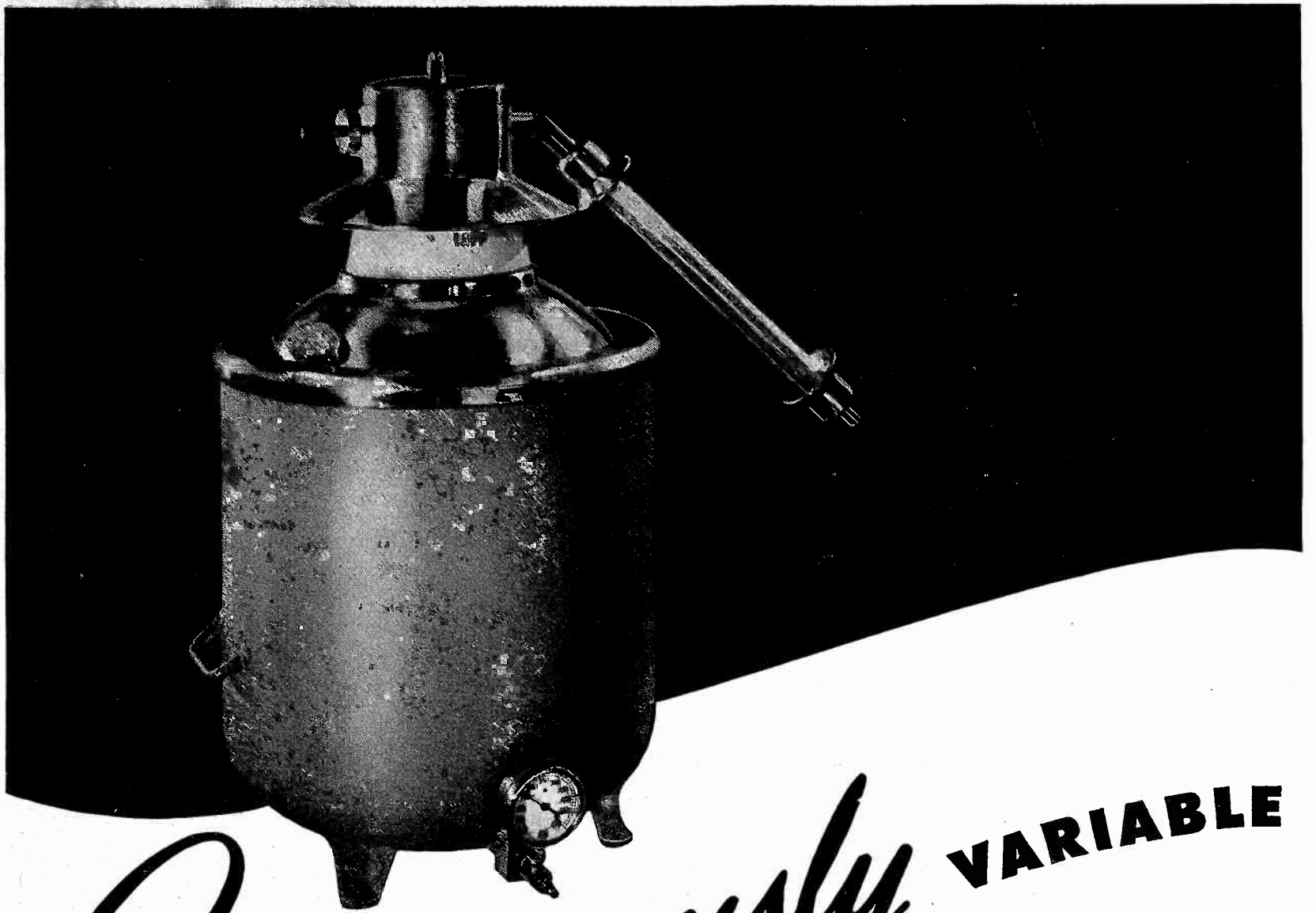

Continuously **VARIABLE**

CAPACITANCE "ON-THE-NOSE" FOR HIGH CURRENT, HIGH POWER ELECTRONIC CIRCUITS

The variable capacitance feature of Lapp Gas-Filled Condensers permits you to "tune-to-a-whisker," with power on, to get the most out of any high current, high power circuit. And once set, this gas-dielectric unit delivers uniformly—no "warm up," no change of capacitance with change in temperature. Non-deteriorating, too, the Lapp unit is truly puncture-proof and will outlast almost any other components of any circuit of which it is a part. In addition to the variable unit, there are adjustable units, continuously adjustable within their range but not designed for frequent "tuning dial" adjustment, and fixed capacitance units. Current ratings range up to 500 amperes R.M.S.; power ratings to 60 Kv peak load. Capacitance to 60,000 mmf. (for fixed units); to 16,000 mmf. (variable and adjustable units). Higher ratings on special design order.

Lapp

LAPP INSULATOR COMPANY, INC., LE ROY, NEW YORK

Every **FEDERAL** Industrial Power Tube is
X-RAY TESTED

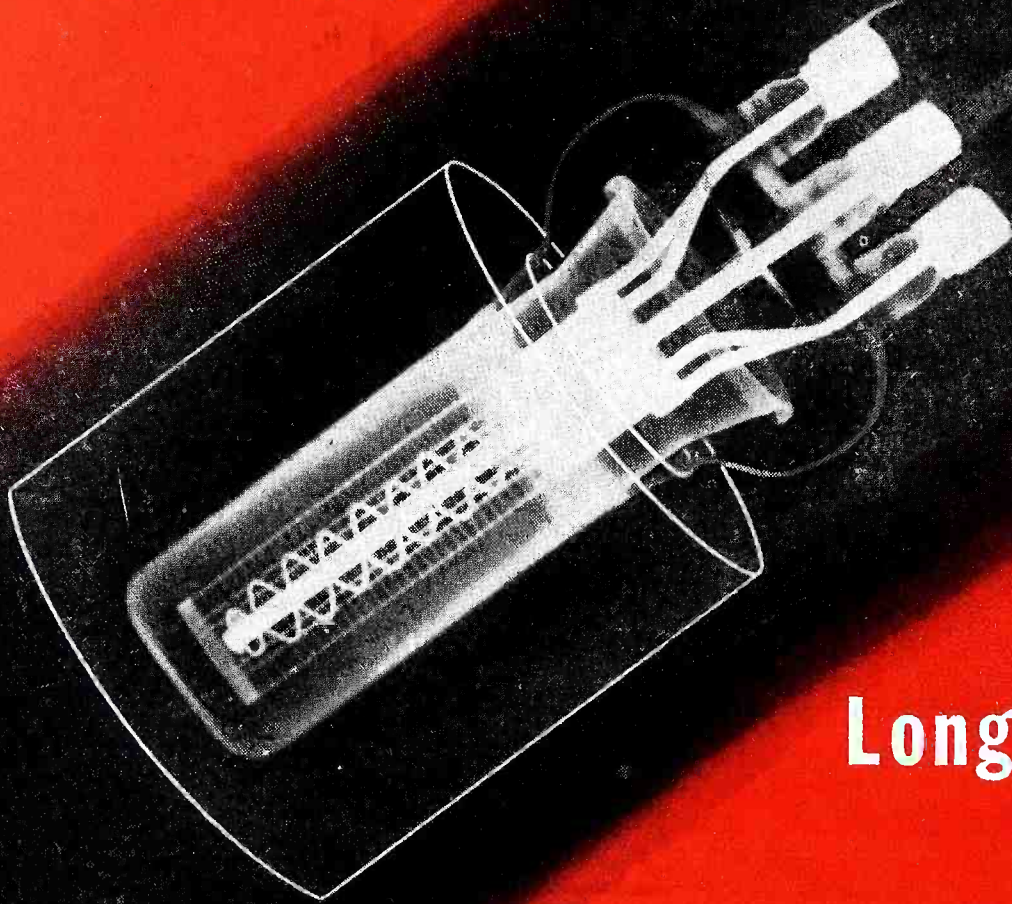

for a
Long, Hard Life

... in Industrial Electronic Equipment like this 2½-KW Dielectric Sealing Unit made by the RADIO RECEPTOR CO. INC., N. Y. C.

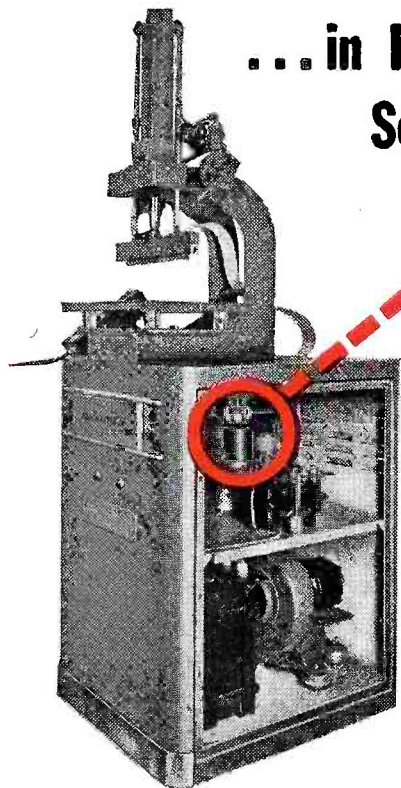

In Federal Power Tubes, there can be no unseen flaws — because the searching eye of X-ray tells the “inside story” of every tube not once, but *twice*, before shipment. This test, together with other exacting requirements, means that each tube must be perfect in every detail — your assurance of longer tube life under the severe conditions of industrial service.

The 7C25, like all of Federal's industrial tubes, is built to take a beating. Wide spacing of internal elements fortify against excessive vibration. Flexible leads simplify installation and reduce strains. And very little unshielded glass is used, minimizing

the possibility of breakage in handling or in service.

For complete information, write to Dept. L313.

DATA FOR 7C25 TUBE

Filament Voltage 11.0 volts
 Filament Current 27.5 amp.

*Maximum Ratings for
 Maximum Frequency of 50 Mc*

DC Plate Voltage 4500 volts
 DC Plate Current 1.25 amp.
 Plate Dissipation 2500 watts

Overall Height App. 7 inches
 Maximum Diameter 3½ inches
 Type of cooling Forced Air

Federal Telephone and Radio Corporation

In Canada: — Federal Electric Manufacturing Company, Ltd., Montreal.
 Export Distributors: — International Standard Electric Corp. 67 Broad St., N. Y.



100 Kingsland Road,
 Clifton, New Jersey

LISTEN

LISTEN

LISTEN

IT'S A

Jensen

SPEAKERS

priced from
\$5 to \$1500

CONSTANTLY INCREASING PRODUCTION

LISTEN



Designers and Manufacturers of Fine Acoustic Equipment

JENSEN MANUFACTURING COMPANY 6607 S. LARAMIE AVE., CHICAGO 38, U.S.A.
In Canada: Copper Wire Products Ltd., 11 King St. W., Toronto, Ont.

Arnold presents:

another step towards a complete line of permanent magnet materials

CAST ALNICO I

CAST ALNICO II

CAST ALNICO III

CAST ALNICO IV

CAST ALNICO V

CAST ALNICO VI

CAST ALNICO XII

SINTERED ALNICO

SINTERED ALNICO

In general SINTERED ALNICO MAGNETS do not compete with, but rather supplement, magnets produced by the cast method to widen the scope of potential permanent magnet applications.

Alnico magnets weighing roughly one ounce or less should be produced by the sintered method.

Heavier magnets of more intricate shapes can be produced. For some applications Sintered magnets are more economical because:

1. Magnetic characteristics are practically the same as Cast Alnico.
2. Sintered Alnico is a fine-grain, homogeneous material which has more uniform flux density, is easier to grind, and provides better surface finish.
3. Sintered Alnico magnets can be produced to closer dimensional tolerances:

SINTERED ALNICO II	CAST ALNICO II
0.000 to 0.125 — + .005	0.000 to 2.00 — ± 1/64
0.126 to 0.625 — + .010	2.0 to 4.0 — ± 1/32
0.626 to 1.250 — + .015	4.0 to 6.0 — ± 3/64
1.251 to 3.000 — + .062	

Grinding can in many applications be eliminated.

4. More intricate shapes, including holes, inserts, etc., are more feasible.
5. Transverse modulus of rupture is several times greater.

All Alnico, and particularly Sintered magnets, have very high values of Coercive Force (which is the capability of resisting demagnetization or loss of magnetism due to stray fields and from heat and vibration).

The curves show roughly the effect of these demagnetization factors on Alnico compared to other alloy steels.

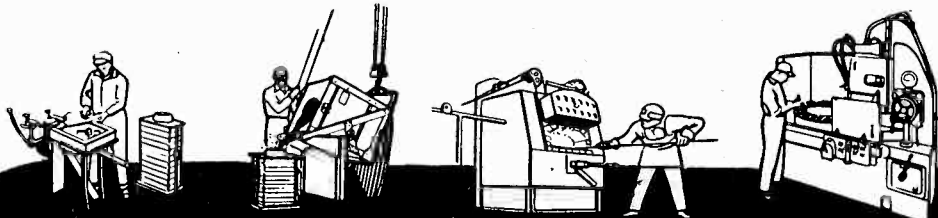
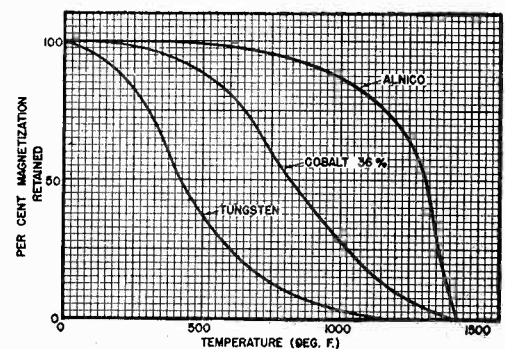
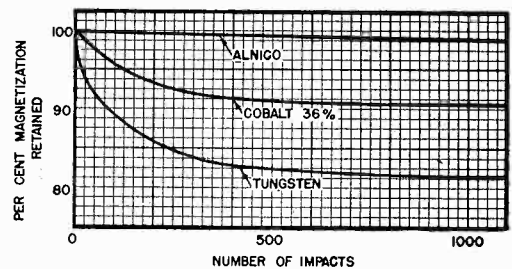
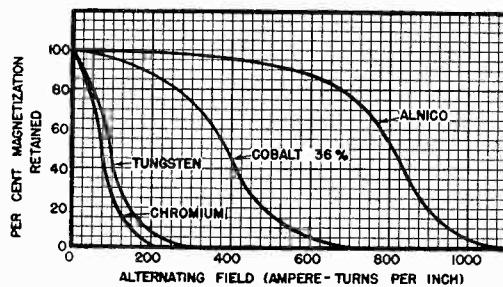

THE ARNOLD ENGINEERING COMPANY

SUBSIDIARY OF ALLEGHENY LUDLUM STEEL CORPORATION

147 EAST ONTARIO STREET, CHICAGO 11, ILLINOIS

Specialists in the manufacture of PERMANENT MAGNET MATERIALS

profit engineering with C-D Capacitors

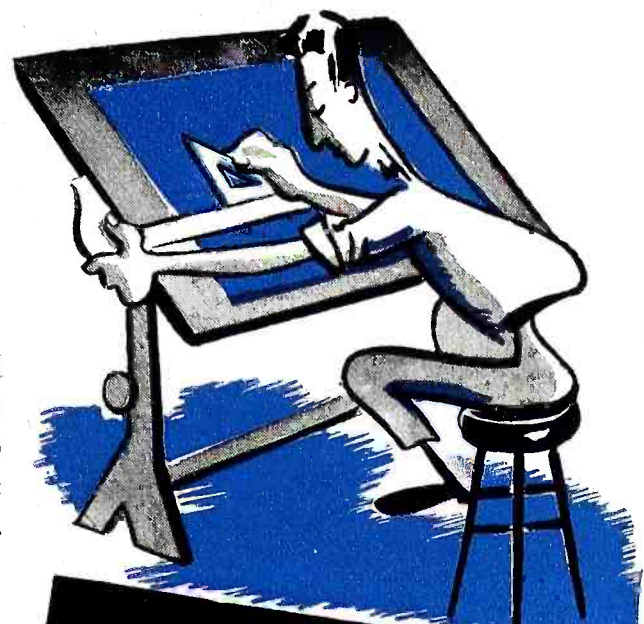

Perhaps you're starting from scratch with a completely new product. Maybe you're sprucing up an old one. Or possibly you'd like to tighten assembly costs—bring your soaring break-even point back to earth. Regardless of what your specific problem may be, if capacitors play a part in your plans, C-D engineers can do a job of profit engineering for you.

Unequaled specialization has enabled us to design and build over 250,000

different types of capacitors. Typical of this experience are the capacitors shown below—designed by C-D engineers to meet the specific production and profit problems of manufacturers like yourself.

**CATALOG OF STANDARD TYPES
AVAILABLE ON REQUEST**

Cornell-Dubilier Electric Corporation,
Dept. K4, South Plainfield, New Jersey.
Other large plants in New Bedford,
Worcester and Brookline, Mass., and
Providence, R. I.

MICA • DYKANOL • PAPER • ELECTROLYTIC

CORNELL-DUBILIER
world's largest manufacturer of
CAPACITORS

1910  1947

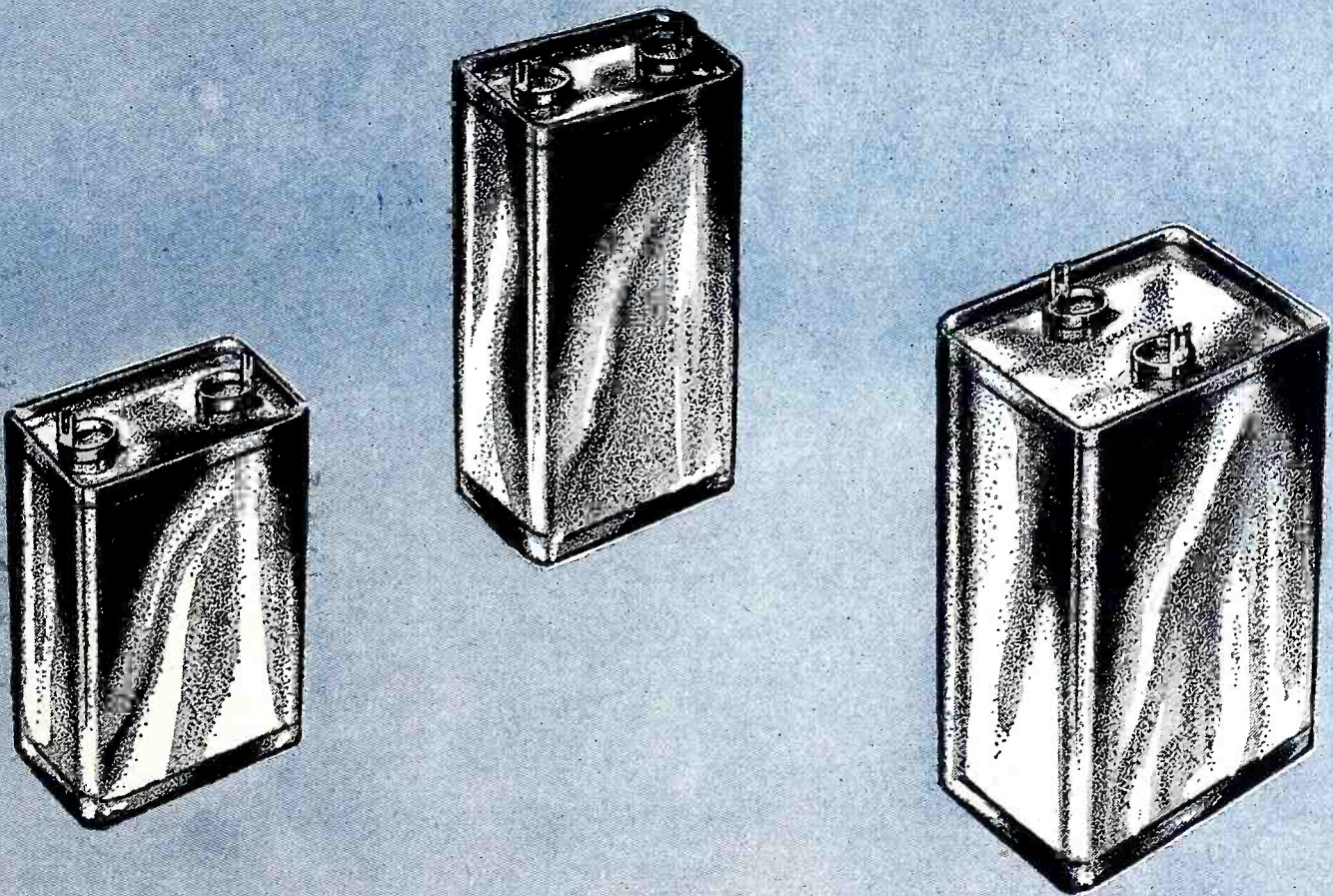

TYPICAL C-D MADE-TO-ORDER CAPACITORS

DESIGNATED AS THE TYPE HKG SERIES, these hermetically-sealed capacitors are available in a wide range of capacities at 2,000 and 2,500 V.D.C. Ruggedly constructed, they embody the research experience of over 37 years devoted exclusively to capacitors.

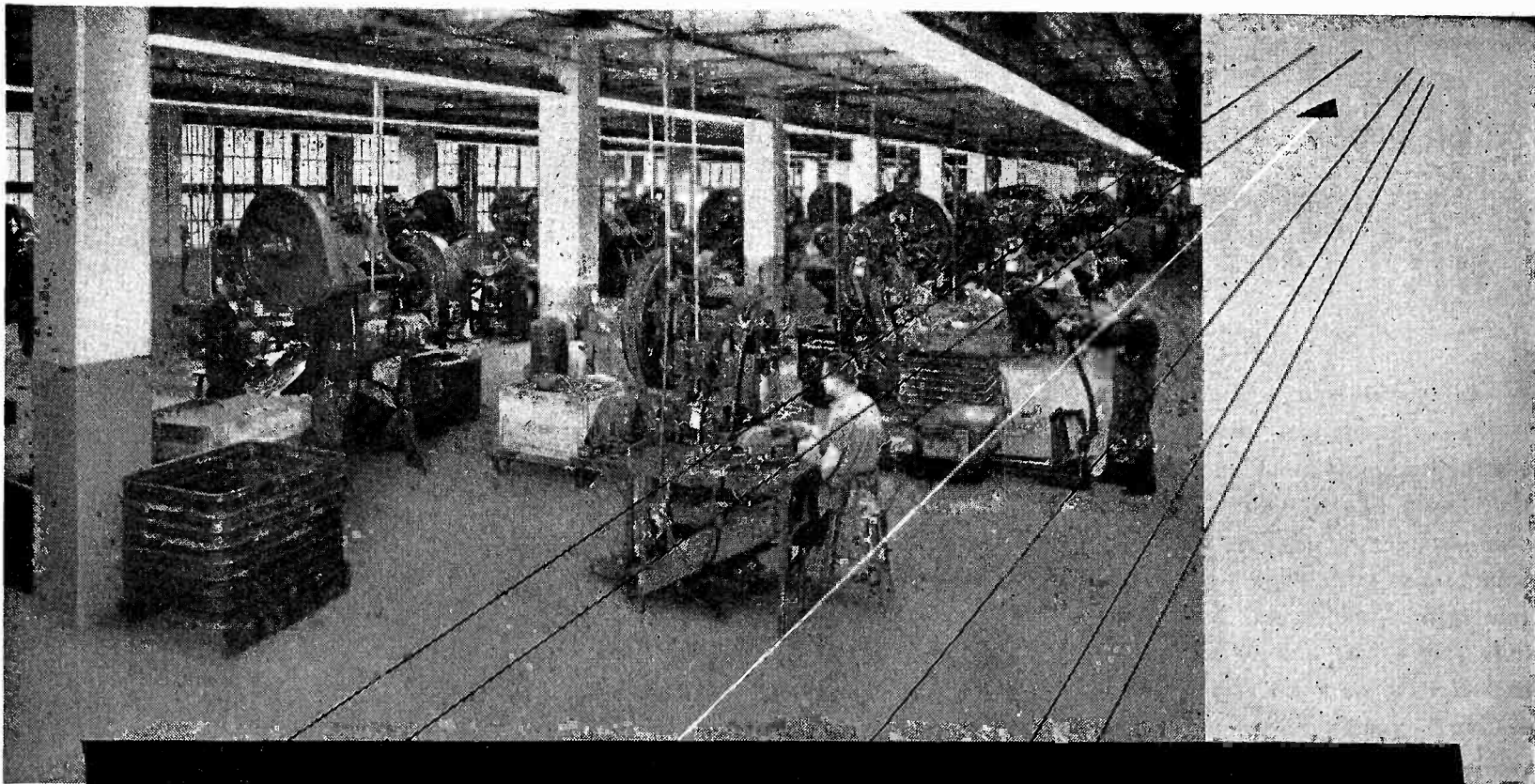

How to Lengthen your Production Line

with **NO** capital investment

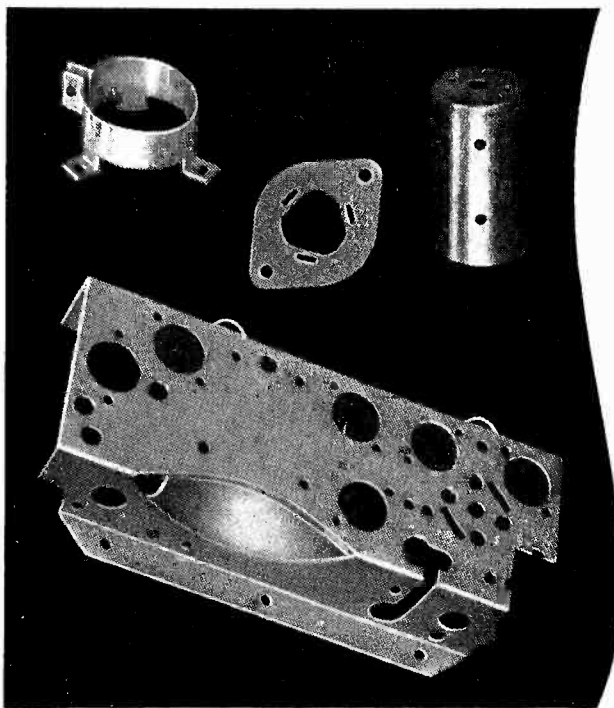

The ability to increase or diversify production without additional investment for plants and machinery puts you a long step ahead of competition. One way to do that . . . to make your production line longer without investing in new equipment . . . is to make use of Paul and Beekman Service.

Paul and Beekman Division specializes in large-scale production of precision metal parts. We have the men, the machines and the organization to turn out parts for you . . . to turn them out fast, and at a cost that will help you remain in a good competitive position.

We'd like to tell you more about our services, and how we'd apply them in your particular case. Write us . . . our engineers are available for consultation with no obligation to you.

Paul and Beekman Division makes all types of precision metal stampings, and complete or sub-assemblies—including condenser cans, mounting clamps, mounting plates, chassis. From mild steel, stainless steel, aluminum, copper or brass—painted or electroplated as required.

PAUL and BEEKMAN *Division* 1805 COURTLAND ST., PHILADELPHIA 40, PA.

PORTABLE PRODUCTS CORPORATION
 MANUFACTURERS OF: LAWN MOWERS • ELECTRICAL APPLIANCES • PRECISION STAMPINGS
 INDUSTRIAL INSTRUMENTS • RADIOS • SAFETY EQUIPMENT

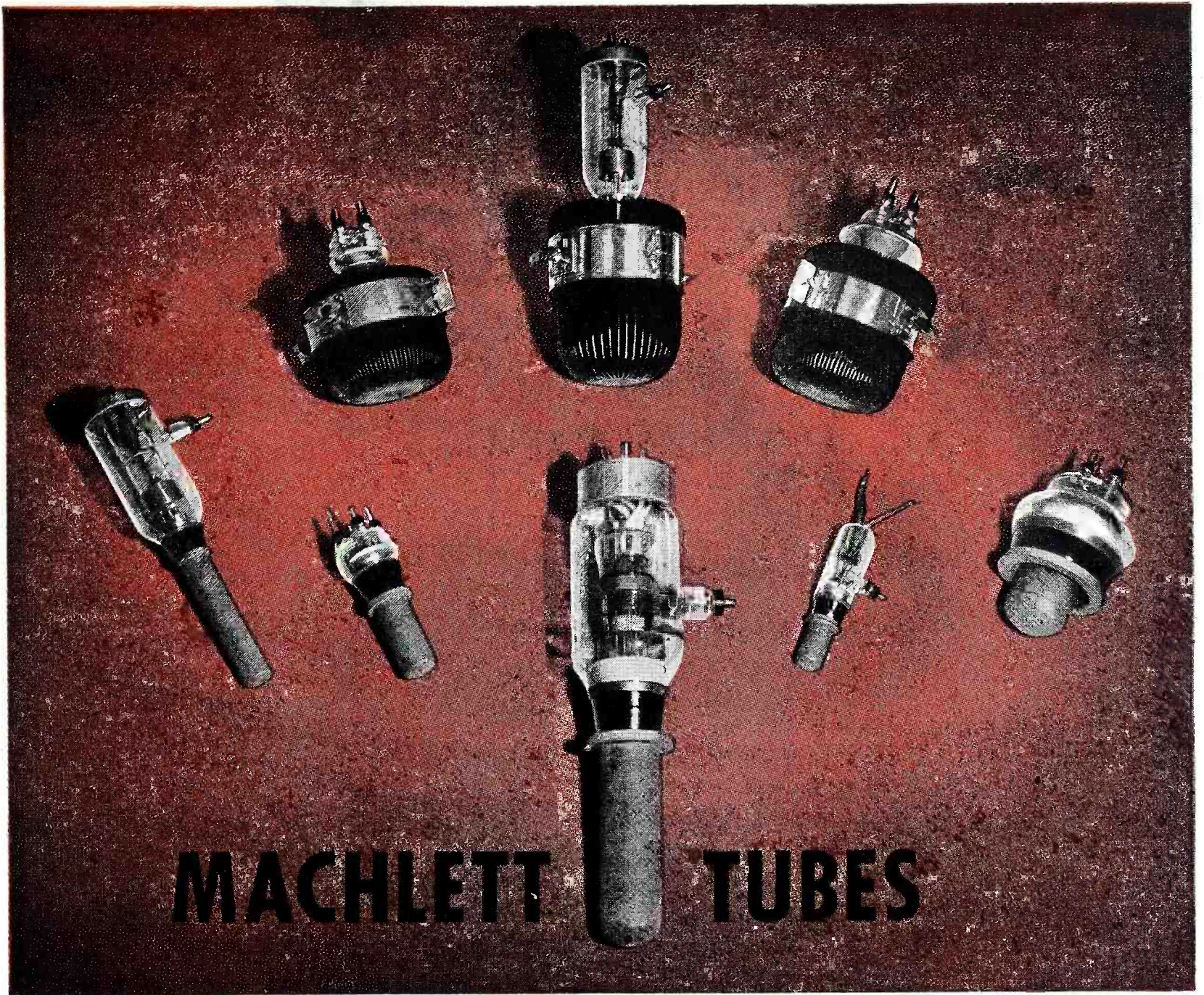

DESIGNED AND PROCESSED FOR LONG LIFE IN R-F HEATING EQUIPMENT

EVER since the first external anode tubes were made, the primary considerations in design, construction and processing were those directed to meeting the requirements of broadcast and communication applications. In those early years, there was little need—and later, little opportunity—to adequately provide for the special and more rigorous requirements of industrial service.

Machlett Laboratories, specialist for half a century in servicing the special electron tube needs of the equipment manufacturer, has long recognized the

necessity for special construction and processing of tubes for industrial use and has been guided by this in every step in the design and manufacture of its water and forced-air cooled tubes for induction and dielectric heating applications. For this reason, Machlett external anode tubes are more rugged, more completely outgassed and have inherently more factors of safety to cope with unusual operating conditions. For longer life and better performance use Machlett electron tubes because they are especially built to fill your needs.

The complete story of what Machlett Laboratories have done and are doing to furnish better tubes to industrial equipment manufacturers and users will be sent upon request. Machlett Laboratories, Inc., Springdale, Conn.



APPLIES TO RADIO AND INDUSTRIAL USES
ITS **50** YEARS OF ELECTRON TUBE EXPERIENCE

**You'll be in good company
using
PLASTICON
WIRE AND CABLE**

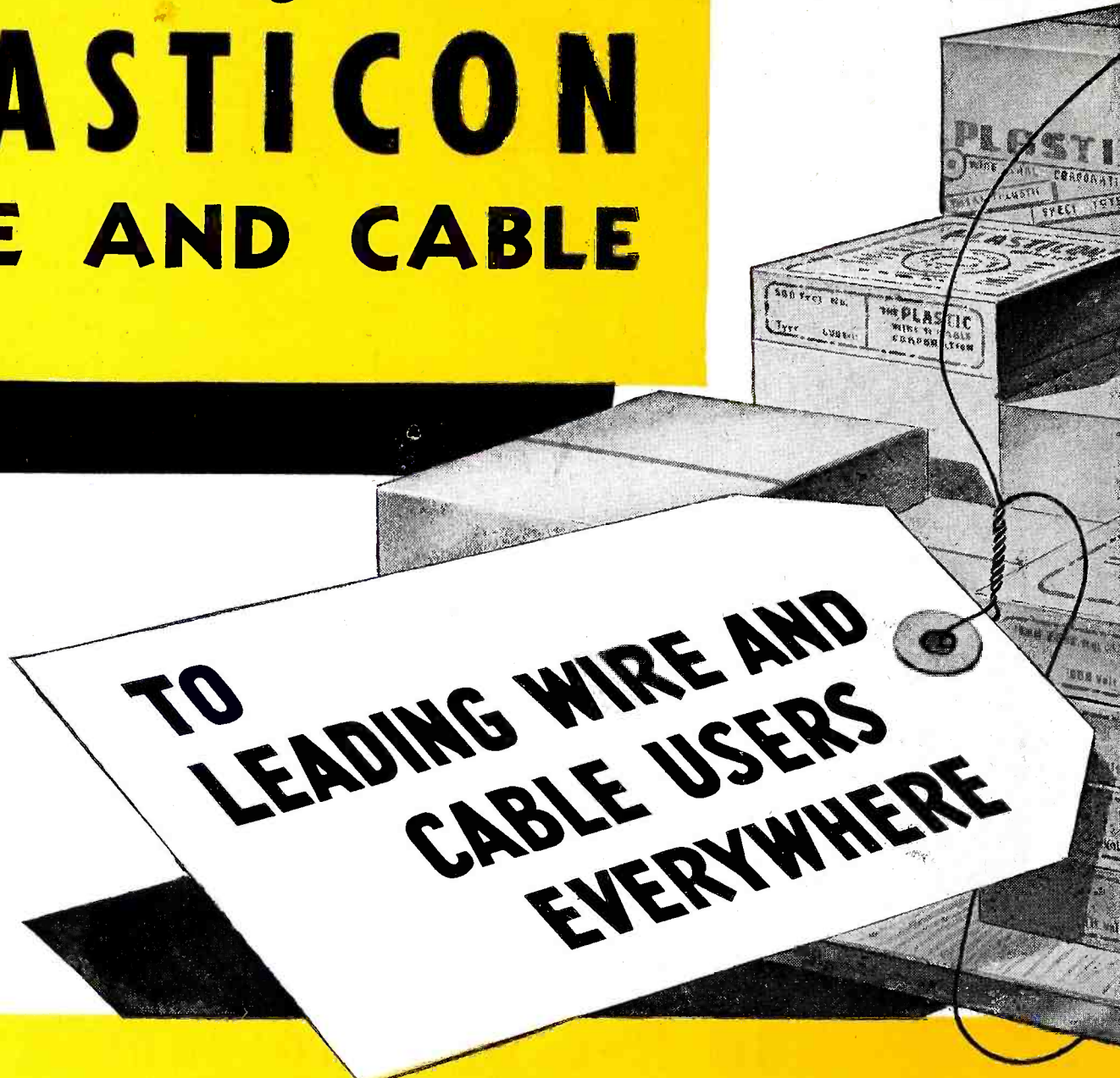

**TO
LEADING WIRE AND
CABLE USERS
EVERYWHERE**

**WHAT CAN ANY INSULATION DO
THAT PLASTIC CAN'T DO BETTER?**

Plastic insulation is a basic permanent improvement because of its inherent qualities and its adaptability to almost any insulation requirement.

PLASTICON stands for plastic-insulated

wire and cable manufactured to the highest standards by Plastic Wire & Cable Corporation — world's largest exclusive producer and pioneer of progress in plastic-insulated conductors. Plastic Wire & Cable engineers are continually expanding the development of plastic compounds to meet the specialized needs of wire and cable users.



PLASTICON

10 WAYS BETTER

1. Greater dielectric strength.
2. Cannot fray, crack or rot.
3. Low moisture absorption.
4. Greater mechanical strength.
5. Higher abrasion resistance.
6. Flexibility at all temperatures.
7. High chemical resistance.
8. Wide range of permanent gem-like colors.
9. Non-combustible.
10. Lasting appearance.

DECIDE FOR YOURSELF!

Our booklet of technical data is packed with facts about the mechanical and dielectric characteristics, resistance to chemicals, aging properties, and other important data of interest and importance to all users of wire and cable. Write for your free copy today, or explain your requirements and let us tell you how PLASTICON can meet them. Plastic Wire & Cable Corporation, 408 East Main Street, Jewett City, Connecticut.

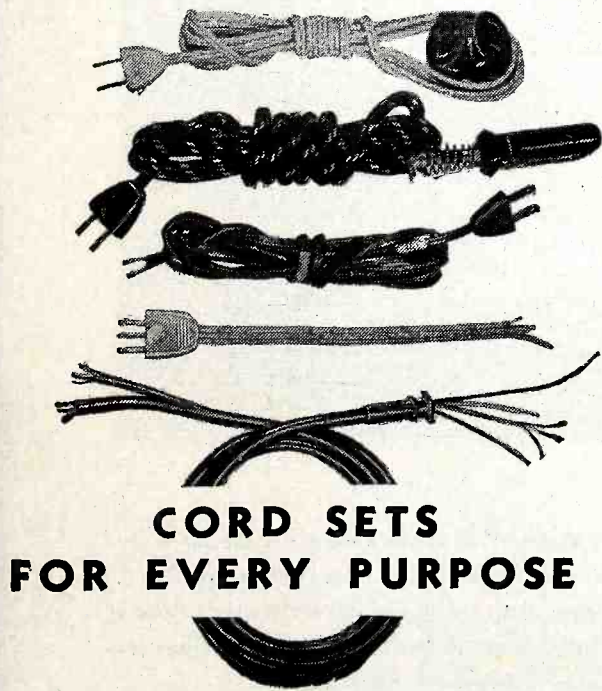
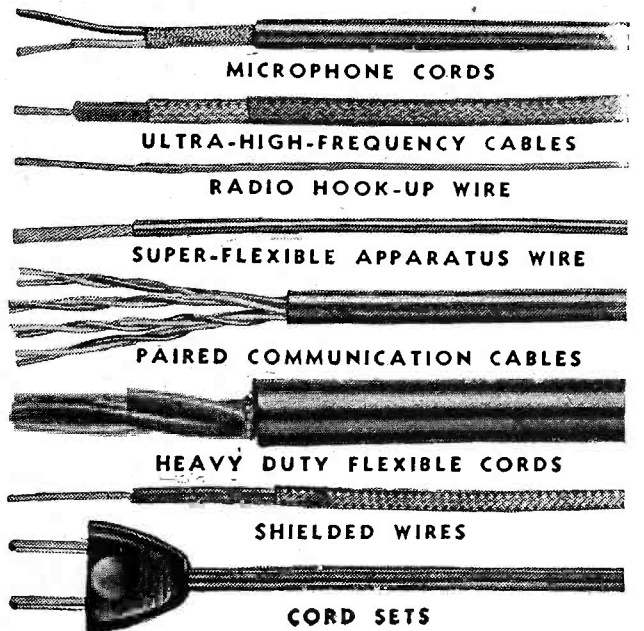

**CORD SETS
FOR EVERY PURPOSE**



New Audio Facilities

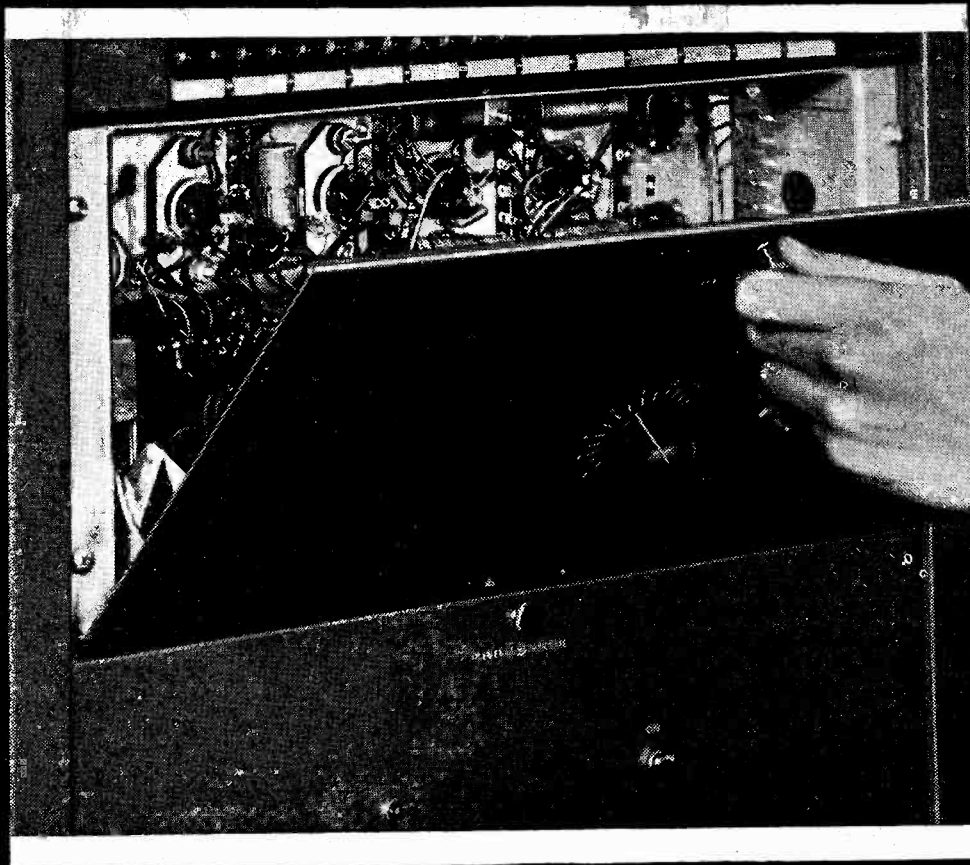

Illustration shows ease of access to Audio rack unit

COMPLETE ACCESSIBILITY

All components instantly accessible without removal of any chassis. Operating controls—switches, lights, meters, gain controls located on front panel. Tubes and plug-in electrolytic capacitors readily accessible from rear of cabinet. Permanently attached, hinged front panels serve as shelves when open, thus providing still greater convenience.

NEWLY STYLED . . . Attractively finished, mechanically clean—these handsome blue-gray audio racks are a complement to any modern studio. Recessed panel mounting and General Electric amplifier construction eliminate the need for accessory trim.

EXCELLENT PERFORMANCE

Extended frequency response, lower noise and distortion levels meet every requirement in FM, AM and TV service. More than satisfies all FCC regulations and latest RMA proposals. Any combination of input and output impedances may be used, with provisions for present 30 and 250 ohm or proposed 150 and 600 ohm microphones.

HIGHLY ADAPTABLE . . . New wiring duct affords maximum ease of installation and flexibility to meet the widest possible variety of station requirements. Full length duct covers and closely spaced wiring ports contribute to neatness of installation.

Audio Equipment
Data Book **FREE**

Free to you for the asking is General Electric's new 44-page technical specification book that describes the new a-f amplifiers, accessories, and loudspeakers. Ask your General Electric broadcast sales engineer for a copy, or write to the *Electronics Department, General Electric Company, Syracuse 1, New York.*

for FM, AM and TV

FEATURING INSTANT ACCESSIBILITY

General Electric's new high-fidelity audio equipment does away with complicated servicing procedures—puts every circuit component within instant reach! It assures you maximum on-the-air reliability, lower cost-per-hour of broadcast service—places your a-f facilities ahead of tomorrow's demands.

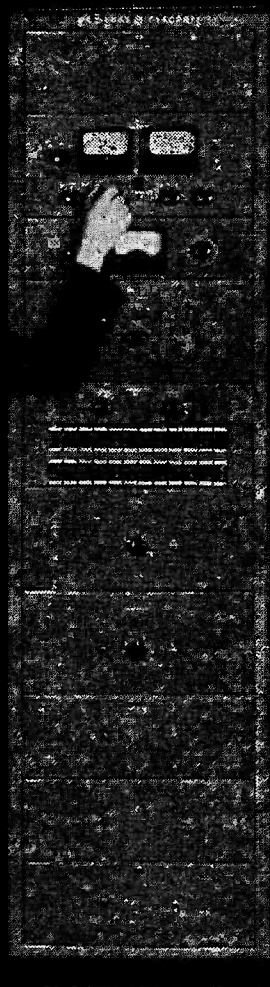

Advanced styling, plus attention to operating details, make this cabinet rack a *must* in the modern broadcast installation. General Electric cabinet racks are sturdy—made of heavy-gauge steel, adequately reinforced. The rigid, no-sag rear door is equipped with a full-size handle and smooth-acting latch.

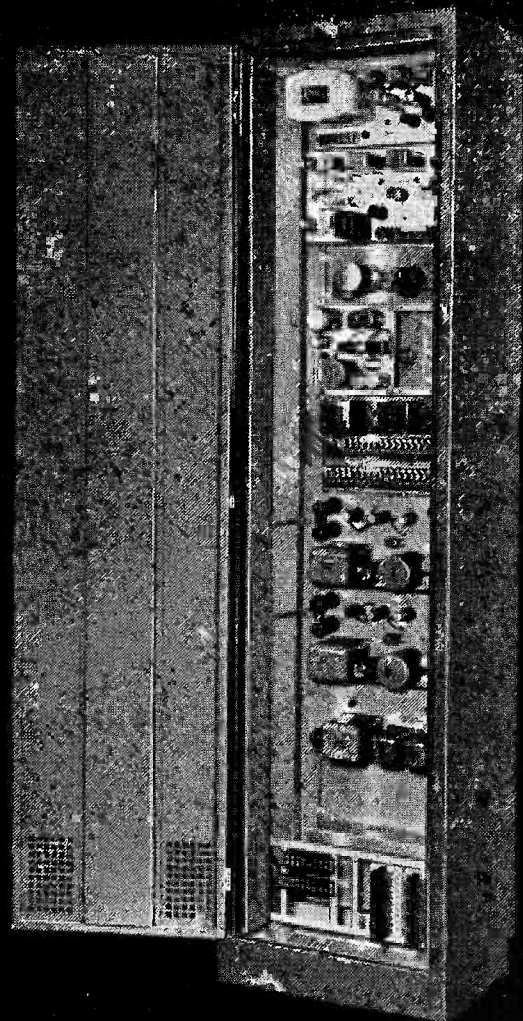

FIRST AND GREATEST NAME IN ELECTRONICS

GENERAL  **ELECTRIC**

160-FL-6814

Brush presents



*A DC Amplifier for use with
Brush Magnetic Oscillographs!*

This is truly a practical D.C. amplifier! It opens new uses for your Brush Direct-Inking Oscillograph. As with all Brush products this new instrument represents years of intensive research in engineering and design. Write today for the complete story . . . Brush representatives will be glad to demonstrate.

Specifications include

- ✓ Frequency Response—uniform from D.C. to 100 cycles per second
- ✓ Voltage Gain—1000 Approximately (one chart millimeter pen displacement per millivolt signal)
- ✓ Stability—drift—less than one chart mm. per hour
- ✓ Calibration Circuit—for convenient determination of input signal levels
- ✓ Centering Control—to position pen electrically to any point on chart
- ✓ Power Requirements—115 volts, 60 cycles
- ✓ Portability—Weight 30 pounds

a product of

The Brush Development Co.

3415 Perkins Ave., Cleveland 14, Ohio

Canadian Representatives: A. C. Wickman, (Canada) Ltd., P. O. Box 9, Station N, Toronto 14

Accent on



MOTION

The Model MS Alliance Powr-Pakt Motor can be mass produced with minor variations to meet the demands of specific jobs which require a highly efficient miniature power plant. Operating over a wide range of AC voltages from 24 to 250 and frequency of 40, 50 or 60 cycles, this compact lightweight motor can be incorporated as the vital power source in all kinds of electrical and mechanical devices.

Here are just a few of the many applications which can use the Alliance Model MS or one of the other Powr-Pakt motors in the Alliance line:

Electronic, electric, radio and time controls, radio tuning and turntable drives, valve and heating controls, coin operated mechanisms, signals, switches, business machines and other specialized uses.

The trend is to make things move!

Designs will call for more action—movement! Flexible product performance needs power sources which are compact, light weight! Alliance Powr-Pakt Motors rated from less than 1-400th on up to 1-20th h. p. will fit those "point-of-action" places! Alliance Motors are mass produced at low cost—engineered for small load jobs!

For vital component power links to actuate controls...to make things move . . . plan to use them!

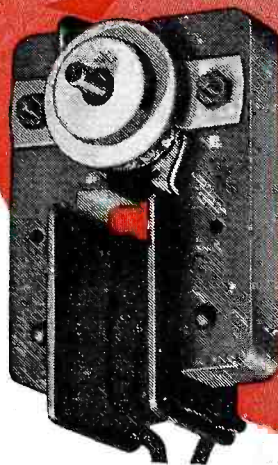

Model MS Shaded Pole Induction Type Motor, size 3 1/2" x 2" x 1 3/4". Weight, 1 lb. 2 oz.



WHEN YOU DESIGN—KEEP

alliance

MOTORS IN MIND

ALLIANCE MANUFACTURING COMPANY • ALLIANCE, OHIO

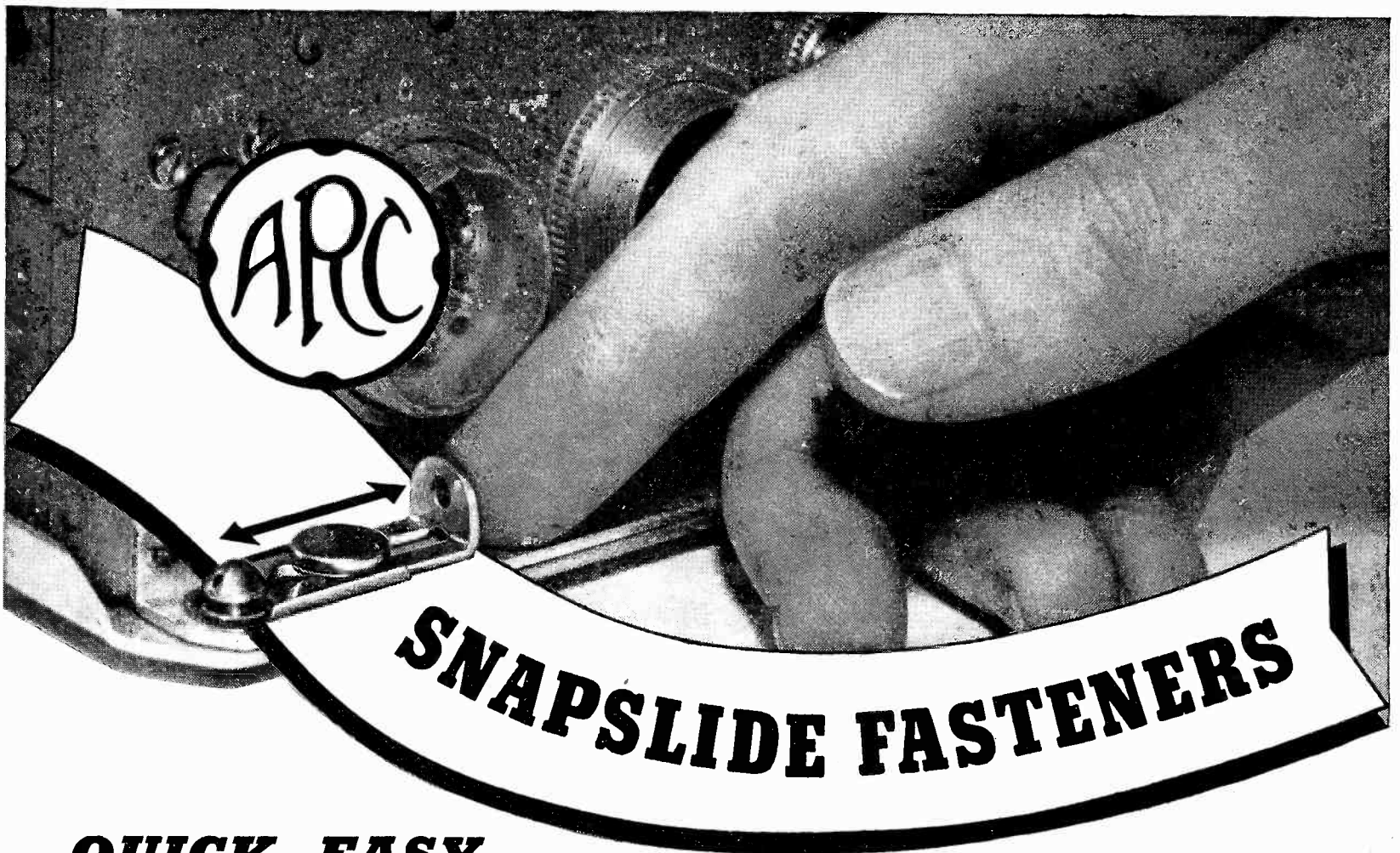

**QUICK, EASY,
ENTIRELY VISIBLE,
NO TOOLS NEEDED**

These Snapslide Fasteners were originated by A. R. C. to provide positive means of attachment and yet to allow instant disengagement. Note how the two spring jaws of the Snapslide lock around the Stud and insure complete security. Both large and small Snapslide Fasteners are available, with Buttons and Studs for various applications and different thicknesses of material.

VARIETY OF USES

Large Snapslides, approximately $\frac{7}{16}$ " wide by 1" long, are suitable for attaching radio sets or such units as dynamotors, converters, etc. to shock absorbers or directly to mounting plates.

Small Snapslides, approximately $\frac{1}{4}$ " wide by $1\frac{1}{32}$ " long, are used to hold down tube covers, fuse covers, and similar light-weight parts.

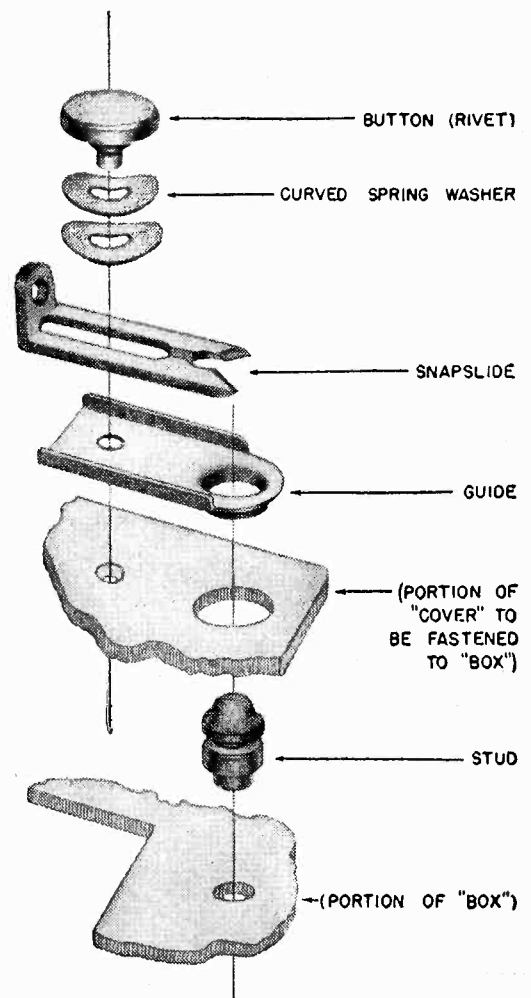

AIRCRAFT RADIO CORPORATION

Boonton, N. J.

Designers and Manufacturers of Radio and Electronic Equipment Since 1928



Steatite

SEALEX



the **GUARANTEED** hermetic seal!

BUSHINGS

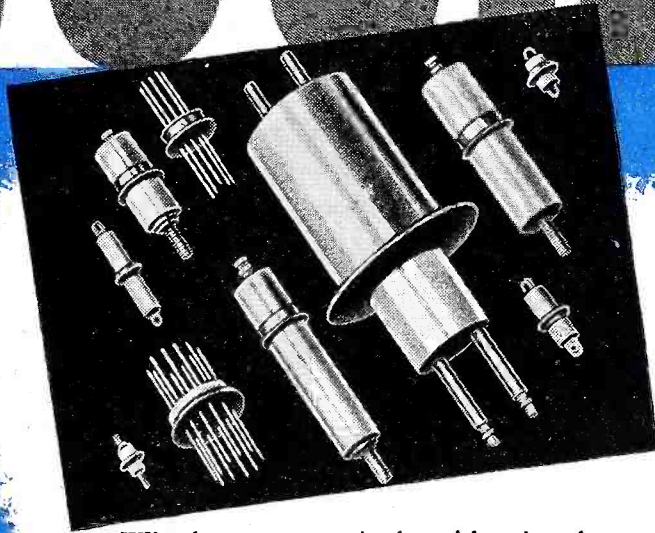

Pressure tested, shockproof Sealed Leads and Multiple Headers

vidually pressure tested at 50 psi; all metal parts are hot-tinned for fast soldering. Sealex Bushings are available in sizes from 0.5 to 20 amps with flash-over ratings to 40 Kilovolts. Steatite — the insulation used in these products — has a low loss factor of only 0.7% at 1000 K. C., which recommends the use of these terminals at practically any frequency.

Whether your terminal problem involves vibration, temperature, hermetic sealing or ordinary lead termination, GENERAL CERAMICS Steatite Sealex Bushings and Multiple Headers offer important advantages that reduce assembly costs and improve product quality. Mounting as a single unit, they can be quickly soldered, welded or sweated to the equipment enclosure and provide perfect termination for one or as many leads as required.

GENERAL CERAMICS Sealex Bushings and Multiple Headers are available in many standard sizes and types suitable for most applications. Special types can be supplied on short notice. Hermetic sealing is absolute and each unit is indi-

WRITE TODAY FOR CATALOG!

GENERAL CERAMICS engineers will gladly assist in applying Steatite Sealex terminals to your equipment, or will collaborate in developing special types for unusual conditions. An informative, fully illustrated catalog covering all General Ceramic insulators, is available free upon request on company letterhead. Write for your copy today!

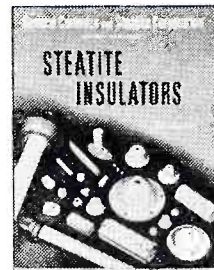

General CERAMICS and STEATITE CORP.

GENERAL OFFICES and PLANT: KEASBY, NEW JERSEY

MAKERS OF STEATITE, TITANATES, ZIRCON PORCELAIN, ALUMINA, LIGHT-DUTY REFRACTORIES, CHEMICAL STONWARE

" We didn't know you could do that with Callite Contacts "

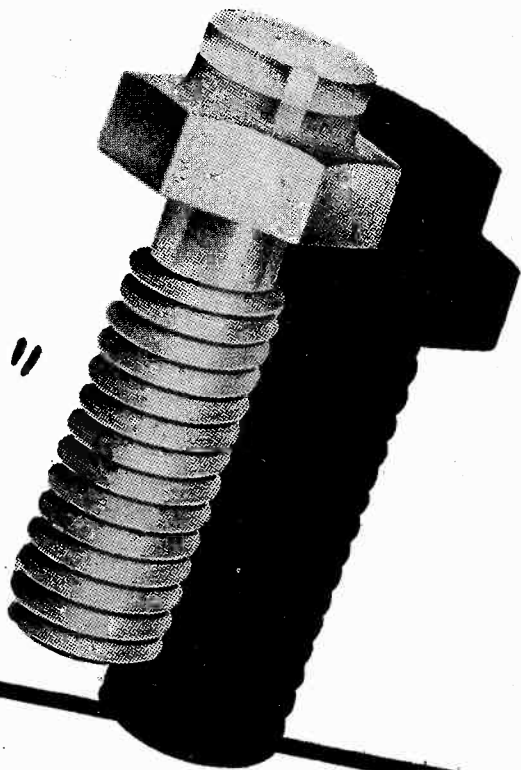

SPARK GAP POINTS

Callite rivet contacts of tungsten provide high current carrying capacity and heat resistance in a prominent electro-surgery unit.

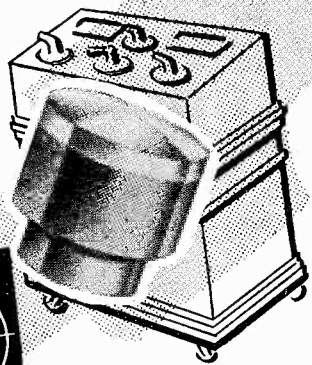
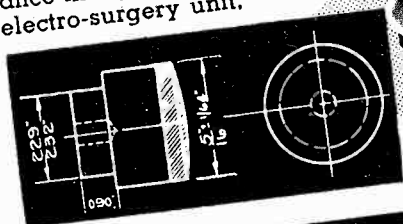

HEAT CONTROL RELAY

Callite rivet contacts of tungsten assure regulated flow of electrical energy in a famous heat control relay.

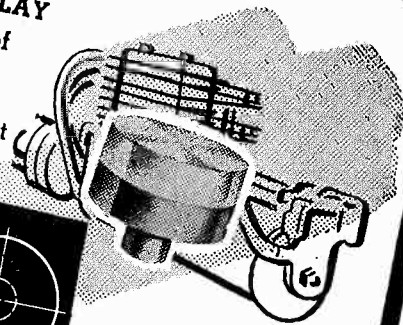
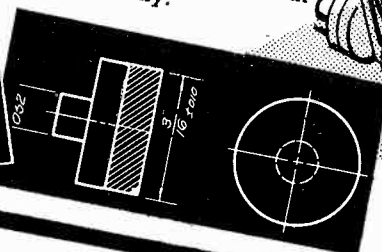

ELECTRICAL RESET RELAY

Callite rivet contacts of tungsten help check coil-energizing in a popular brand of electrical reset relays.

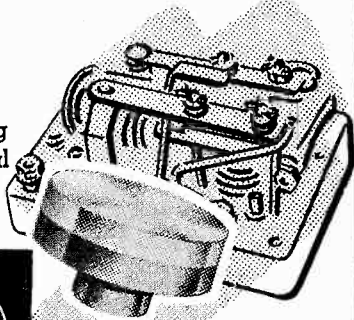
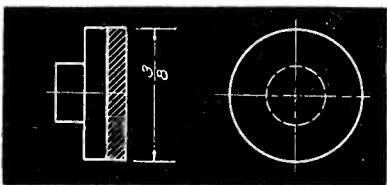

IGNITION ELECTRODE

Callite rivet contacts of tungsten give instant cylinder firing action to a leading aviation magneto.

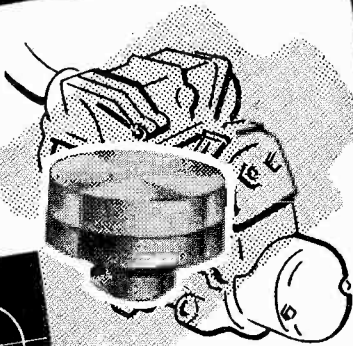
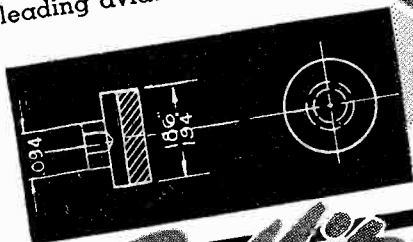

Illustrated above are four contacts that are not for sale. They were designed—after close collaboration between each manufacturer's staff and ours—for highly individual contact applications. But the same resourcefulness and engineering flexibility that produced these special designs can also be applied to furnishing the exact contact you need for your own equipment. In 26 years of specialization and pioneering with component metallurgy, we have amassed thousands of tried-and-tested stock contact types as well as the experience to produce any type not yet devised. Call your Callite engineer for an estimate. Callite Tungsten Corp., 544 Thirty-ninth St., Union City, N. J. Branch Offices: Chicago, Cleveland.

Callite
CONTACTS



Standard and special shapes in tungsten, molybdenum, silver, platinum, palladium and alloys of these metals. Write for Catalog #152 which describes stock contacts and extraordinary designs used in special applications.



Impervious TO ATMOSPHERIC MOISTURE

Proof AGAINST INDUSTRIAL FUMES . . .

Unaffected BY EXTREME HEAT OR COLD

Withstand SEVERE MECHANICAL SHOCKS

. . . in short, constructed to last under the worst of operating conditions.

★ Although essentially fitted for the "tough" applications, Chicago Transformer's *Sealed in Steel* construction is being specified with increasing frequency by engineers who design electronic equipment for only average, or normal, conditions, but who, because of the vital services performed by their products, require an extra margin of dependability.

Their reasoning —

(a) Water vapor, oxygen, and carbon dioxide exist in all atmospheres; chlorine and sulphur compounds in the air of industrial localities.

(b) The action of these agents, intensified by heat and direct current potentials, corrodes copper coil windings, shortens transformer life.

(c) Moisture, even when not excessive in the air, frequently condenses on the inside of partially sealed or unsealed cases and shields as the result of variations in temperature.

Their conclusion —

It is good engineering to specify the transformers that have met with outstanding success the most rigid military tests for sealing against corrosion, have been proven to stay sealed in extremes of heat and cold . . . Chicago Transformers, *Sealed in Steel*.

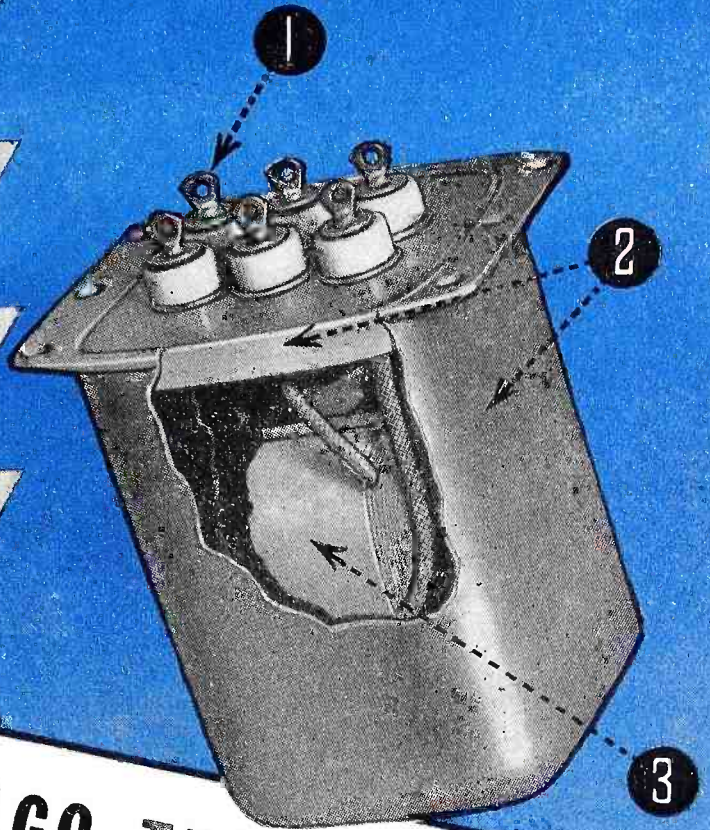

CHICAGO TRANSFORMERS
Sealed in Steel
FOR LASTING DEPENDABILITY

- 1 C.T.'s exclusive Bushing-Gasket Seal at terminals employs tough resilient gaskets to permanently seal all openings and to cushion terminals and bushings against mechanical shock or drastic changes in temperature. (No cracking because of sudden heat transfer from soldering iron to terminals during chassis assembly operation.)
- 2 Seamless, Drawn Steel Case and C.T.-innovated Deep Seal Base Cover provide a strong, impenetrable housing which, with its compact, modern, and streamlined "good looks," helps sell the equipment in which it appears.
- 3 Coil is impregnated by a process using heat and alternate cycles of vacuum and pressure. By use of vacuum, all moisture is withdrawn from the coil, while pressure and heat thoroughly impregnate it with wax or varnish. Superior to ordinary impregnation processes, this method insures that the transformer is potted without moisture trapped inside.



CHICAGO TRANSFORMER

DIVISION OF ESSEX WIRE CORPORATION

3501 ADDISON STREET • CHICAGO 18, ILLINOIS



saves costly time

**Training
New Assembly Workers
by using
PHILLIPS SCREWS**

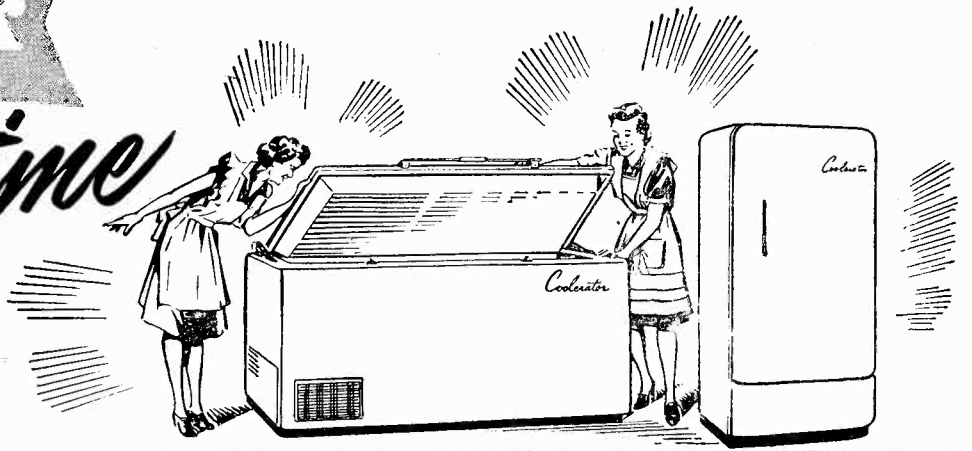

Highlights from a comprehensive report by independent investigator of James O. Peck Co.—one of their studies of assembly savings made with Phillips Screws in leading plants...

● "WE made an important saving we hadn't counted on when we switched to Phillips Recessed Head Screws," said the foreman of Coolerator's assembly line. "Instead of the expensively long period usually required to train operators to drive slotted screws, we found that new people could start driving Phillips Screws with a few simple instructions. Since we use about 125 Phillips Screws in every Coolerator and our daily production is 800, there isn't much time for teaching anyone how to drive a screw.

"EASIER TO USE, especially in awkward or blind applications... like fastening the black base to the bottom of the unit or attaching the ice container to the box. You have practically no control over slotted screws, while Phillips Screws are easy to line up.

"STOPPED PANEL DAMAGE and burring of heads. Assembly people used to almost write their names on the sides of the units when a slotted screw driver slipped. That cost real money... for disassembly, refinishing and reassembly, not to mention the disruption of the assembly line. Phillips Screws ended slips.

THE WHOLE STORY of this and other assembly studies in key plants... covering metal, wood and plastic products... will suggest similar savings to any production man. This coupon will bring you these reports—FREE. Mail it now.

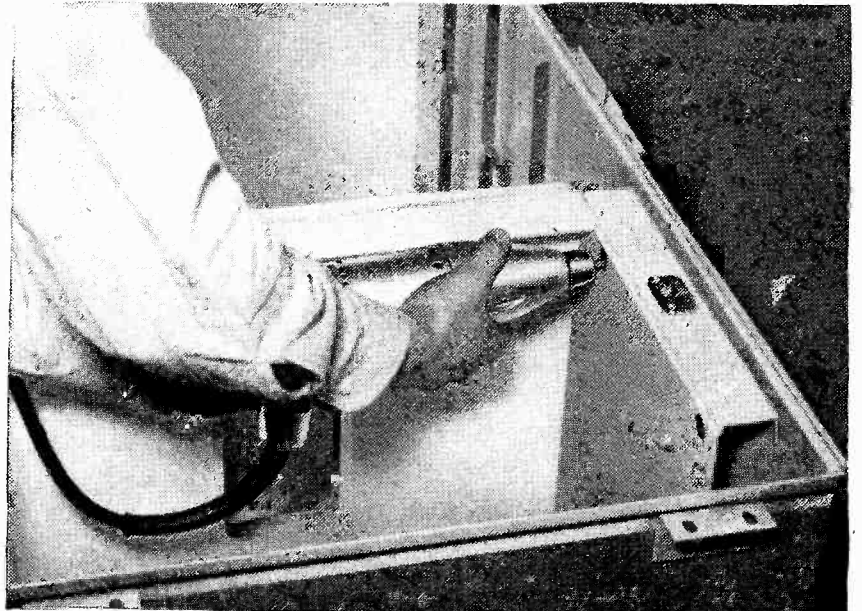

Here's a tricky bit of "blind" driving... through a small hole in the ice unit. With Phillips Screws, locating and driving is easier.

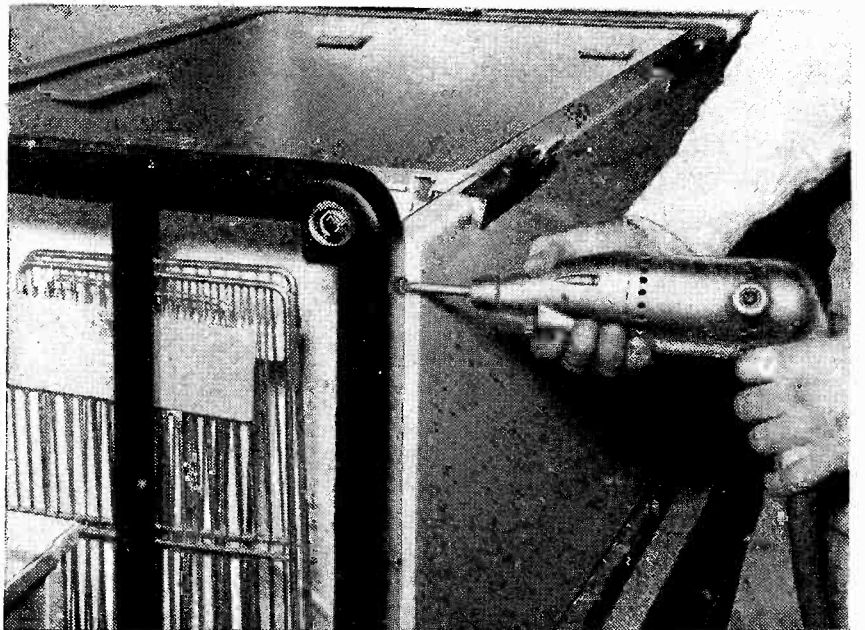

If ordinary slotted screws were used in fastening this black enameled base, inevitable driver slippage would do costly damage to the adjacent panels.

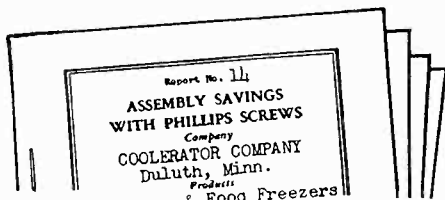

.....

• Phillips Screw Mfrs., c/o Horton-Noyes E-16

• 2300 Industrial Trust Bldg.,

• Providence, R. I.

• Send me reports on Assembly Savings with Phillips Screws.

• Name

• Company

• Address

.....

PHILLIPS *Recessed Head* SCREWS

Wood Screws • Machine Screws • Self-tapping Screws • Stove Bolts

- American Screw Co.
- Central Screw Co.
- Continental Screw Co.
- Corbin Screw Div. of
- American Hdwe. Corp.
- The H. M. Harper Co.
- International Screw Co.
- Lamson & Sessions Co.
- Milford Rivet and Machine Co.

23 SOURCES

- Pheoll Manufacturing Co.
- National Lock Co.
- National Screw & Mfg. Co.
- New England Screw Co.
- Parker-Kalon Corporation
- Pawtucket Screw Co.

- Reading Screw Co.
- Russell Burdshall & Ward Bolt & Nut Co.
- Scovill Manufacturing Co.
- Shakeproof Inc.
- The Southington Hardware Mfg. Co.
- The Steel Company of Canada, Ltd.
- Sterling Bolt Co.
- Stronghold Screw Products, Inc.
- Wolverine Bolt Company

Going places
(AGAIN)

hallicrafters

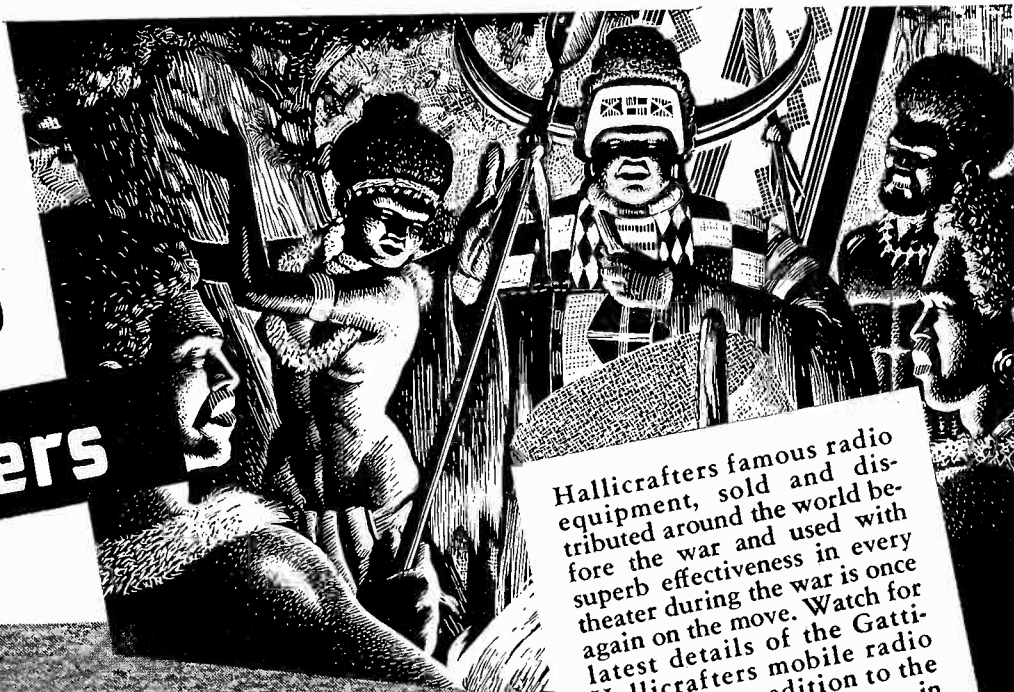

Hallicrafters famous radio equipment, sold and distributed around the world before the war and used with superb effectiveness in every theater during the war is once again on the move. Watch for latest details of the Gattilone Hallicrafters mobile radio equipped expedition to the Mountains of the Moon in deepest Africa—a new and exciting test for the ingenuity of hams and the performance of Hallicrafters equipment.

3

GREAT RECEIVERS designed and priced for hams who are going places, too



Model SX-42 Described by hams who have operated it as "the first real postwar receiver." One of the finest CW receivers yet developed. Greatest continuous frequency coverage of any communications receiver—from 540 kc to 110 Mc, in six bands. FM-AM-CW. 15 tubes. Matching speakers available. **\$27500**



Model S-40A Function, beauty, unusual radio performance and reasonable price are all combined in this fine receiver. Overall frequency range from 540 kc to 43 Mc, in four bands. Nine tubes. Built-in dynamic speaker. Many circuit refinements never before available in medium price class. **\$8950**

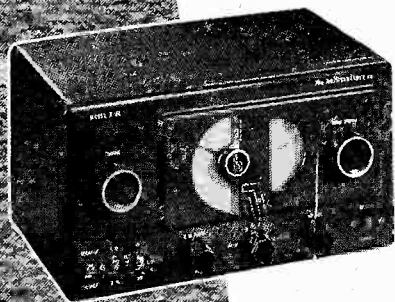

Model S-38 Overall frequency range from 540 kc to 32 Mc, in four bands. Self contained speaker. Compact and rugged, high performance at a low price. Makes an ideal standby receiver for hams. CW pitch control is adjustable from front panel. Automatic noise limiter. **\$4750**

Prices slightly higher in zone 2

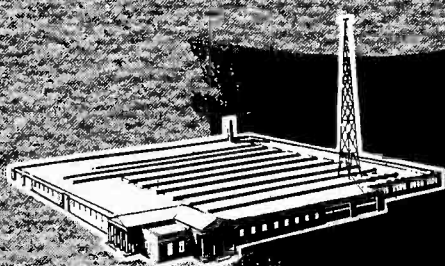

BUILDERS OF *Skyfone* AVIATION RADIO-TELEPHONE

hallicrafters RADIO

THE HALLICRAFTERS CO., MANUFACTURERS OF RADIO AND ELECTRONIC EQUIPMENT, CHICAGO 16, U. S. A.

Sole Hallicrafters Representatives in Canada: Rogers Majestic Limited, Toronto-Montreal

SPRAGUE VITAMIN Q DIELECTRIC

(TRADEMARK REG. U. S. PAT. OFF.)

HAS PERMITTED
SUBSTANTIAL RE-
DUCTIONS IN BOTH
THE SIZE AND WEIGHT
OF MANY OIL-FILLED
CAPACITOR TYPES

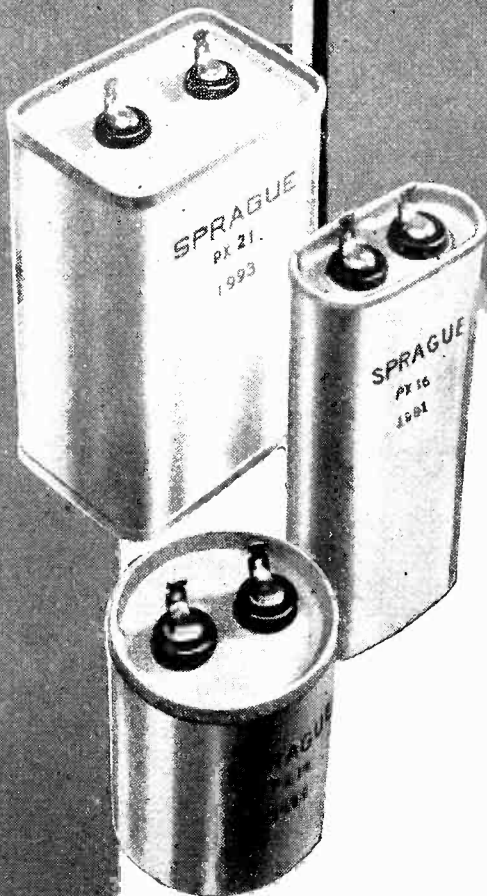

TYPICAL! *Greatly Increased Life for Fluorescent Lamp Capacitors*

The application of Vitamin Q dielectric to Sprague Fluorescent Lamp Ballast Capacitors has established new, higher standards of performance under all conditions of use. Standard $3\frac{1}{2}$ mfd. 330 volt capacitors in 2" round containers were tested competitively for 750 hours at 575v. A-C at 85°C. in still air. Not one of the Sprague Capacitors failed. All competing units by three other manufacturers failed within four hours. Write for Sprague Technical Data Bulletin No. 3200.

SPRAGUE ELECTRIC COMPANY, North Adams, Mass.

PIONEERS OF ELECTRIC AND ELECTRONIC PROGRESS

Another new product
from a Du Pont Plastic



NYLON GROMMET WITH A VISE-LIKE GRIP

New safety for appliances . . . molded from a Du Pont plastic

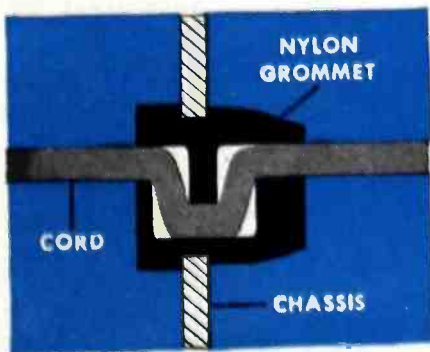

HOW NEW GROMMET WORKS

Grommet is two-piece assembly. Wire is placed across base piece. Top section is squeezed into assembly with pliers, locking wire in a safe hairpin turn. Grommet is then snapped into hole in appliance chassis. (Nylon grommet molded by Mack Molding Co., Inc., Wayne, N. J., for Heyman Manufacturing Co., Kenilworth, New Jersey.)

WELCOME NEWS for appliance manufacturers, underwriters and consumers is a new strain-relief grommet (or bushing) molded from Du Pont nylon.

Anchored into the chassis of the appliance, this mighty little nylon grommet keeps a tight, safe grip on lead-in wire. It absorbs the stresses of tugs and twists . . . protects connections against stripping, short circuits and moisture . . . adds a safety feature and a sales boost too. Nylon outpointed all other grommet materials tested by the manufacturer. Under heat test, for example, the nylon grommet withstands temperatures up to 400°F. It is economical to install . . . and it lasts the life of the equipment.

Want to improve an old product . . . design a new one? Look to nylon . . .

and other Du Pont plastics . . . for a lift to success and more sales. Write for literature. E. I. du Pont de Nemours & Co. (Inc.), Plastics Department, Room 154, Arlington, New Jersey.





Stupakoff Ceramics

Meet Exacting
Requirements
for

ELECTRONIC TUBES and COMPONENTS

Precision Ceramic parts for highly sensitive Cathode Ray and other tubes—and for electronic components, require extremely close tolerances, highest quality materials and correct engineering. Such parts are constantly produced by STUPAKOFF.

The dimensional accuracy and sturdy structure of STUPAKOFF Ceramics speed fabrication processes, improve your products, make faster assembly possible and assure greater satisfaction. Standardize on STUPAKOFF for all your ceramic needs.

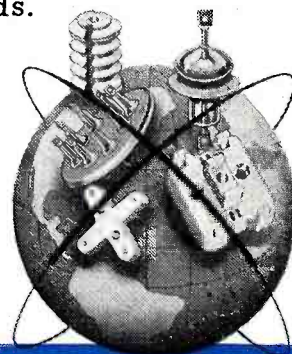

STUPAKOFF

CERAMIC AND MANUFACTURING CO. • LATROBE, PA.

EXPORT DEPARTMENT 13 E. 40TH ST., NEW YORK 16, N. Y. CABLE ADDRESS ARLAB ALL CODES

Hit of I.R.E. Convention

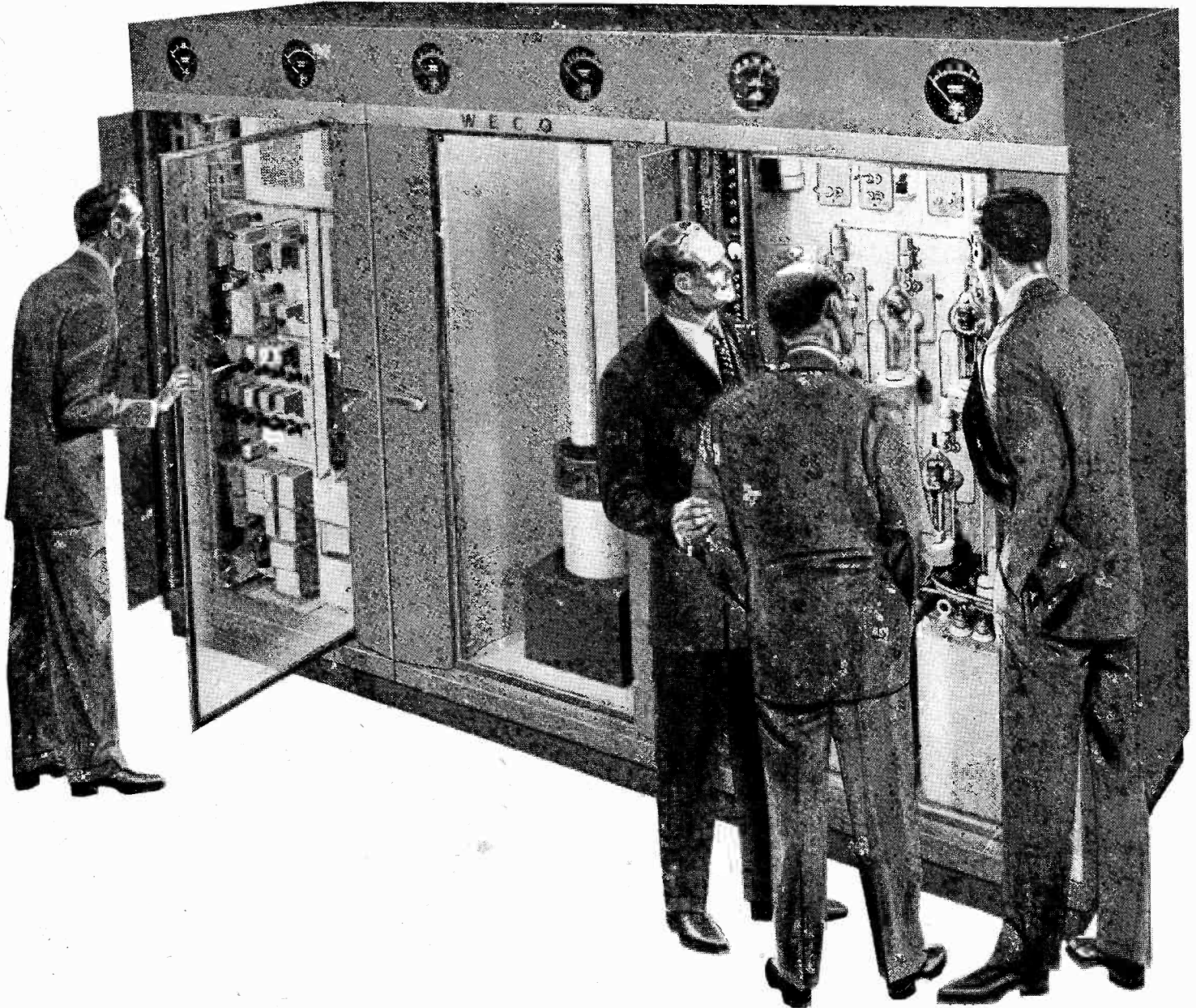

Western Electric 10 KW TRANSVIEW design FM Transmitter



Western Electric's new 10 kw FM transmitter is still the talk of broadcasters who saw it at the recent I.R.E. Convention.

Its sleek, business-like appearance, with full length glass doors and an unobstructed view of all tubes, caught their eye—but they were even more impressed by its technical characteristics and operating advantages.

Particularly, they liked its *low intermodulation* and *low harmonic distortion*, its *Synchronizer* for precise frequency control, and its *Arc-*

Back Indicator, a new circuit for quick and accurate location of a faulty mercury vapor rectifier tube.

Western Electric's complete line of TRANSVIEW design FM transmitters will range from 250 watts to 50 kw. For full information, call your local Graybar Broadcast Representative or write to Graybar Electric Co., 420 Lexington Avenue, New York 17, N. Y.

— **QUALITY COUNTS** —

Seeburg Changers for every radio-phonograph combination

• To help manufacturers provide the finest radio-phonograph combinations, Seeburg offers three outstanding changers—the "M," the "L" and the "K."

While each is designed for use in radio-phonograph combinations of various price ranges, all are engineered to bring the

maximum in listening pleasure. Whatever Seeburg changers you build into your combinations, you may count on quiet, simple operation . . . constant, sustained speed . . . minimum time between changes . . . longer record life . . . the ultimate in reproduction fidelity.

the Seeburg "M"...

The new, deluxe changer that lends appeal to the most glamorous radio-phonograph combinations. Exclusive, three-post construction permits intermixed playing of 10 and 12-inch records . . . assures longer record life . . . increases record load. Capacity of fourteen 10-inch records, twelve 12-inch records or twelve 10-inch and 12-inch records intermixed. Size: 14¼ x 14¼ in.

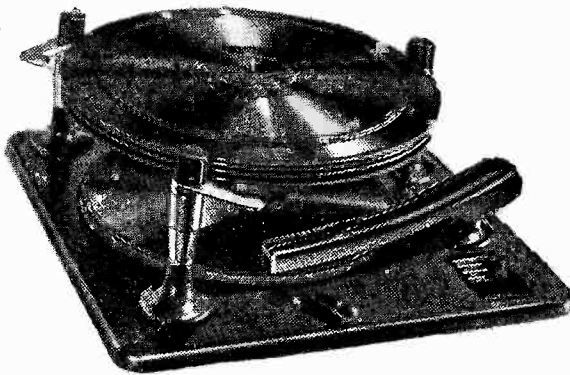

... the Seeburg "L"

A finely engineered changer to enhance the listening pleasure of your beautiful table and console radio phonograph combinations. Two-post construction. Capacity: fourteen 10-inch or ten 12-inch recordings. Size: 14¼ x 14¼ in.

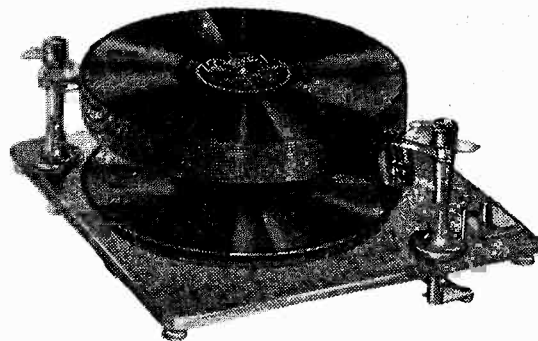

the Seeburg "K"

A simplified, compact mechanism to bring fine reproduction to competitively priced units. Two-post construction. Capacity of fourteen 10-inch or ten 12-inch recordings. Size: 12½ x 12½ in.

Seeburg

RECORD CHANGERS ★ MUSIC SYSTEMS

J. P. SEEBURG CORPORATION
1500 N. DAYTON ST. • CHICAGO, 22



Joe knows you can't kid calipers!

Richardson tool makers are trained to respect tolerances. This is exact work with us... no guesses allowed! Joe and others like him, are skilled from feet to finger tips. They learned the ropes a long time ago and their craftsmanship is paying dividends today.

To whom? To any Richardson customer... or prospective customer... who wants to feel confident that his job is being handled by men who aren't baffled by complications; by men with the ability to take every job in stride... delivering a really *complete* service... from plan to finished product.

We often build special equipment to meet our own production needs. *Versatility in plastics*... that's what we call it. Why not see how it works... for you?

We will be glad to welcome you at the S. P. I. National Plastics Exposition, Booth 16, Chicago, May 6 to 10.

INSUROK *Precision Plastics*

The RICHARDSON COMPANY

Sales Headquarters: MELROSE PARK, ILL. FOUNDED 1858 LOCKLAND, CINCINNATI 15, OHIO
 NEW YORK 6, 75 WEST STREET Sales Offices ROCHESTER 4, N. Y., 1031 SIBLEY TOWER BLDG.
 PHILADELPHIA 40, PA., 3728 NO. BROAD STREET MILWAUKEE 3, WIS., 743 NO. FOURTH STREET
 CLEVELAND 15, OHIO, 326-7 PLYMOUTH BLDG. DETROIT 2, MICH., 6-252 G. M. BLDG. ST. LOUIS 12, MO., 5579 PERSHING AVENUE
 Factories: MELROSE PARK, ILL. NEW BRUNSWICK, N. J. INDIANAPOLIS, IND.

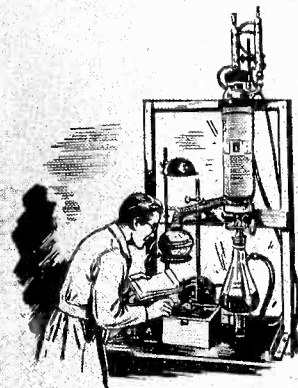

* RESEARCH
 ... a continuous transformation of possibilities into practical ideas in plastics.



* DESIGNING
 ... Artistic visualization. Creative engineering. Practical planning for efficient plastics production.



* LAMINATING
 ... Sheets, rods, tubes. Standard NEMA grades; over 100 special grades.

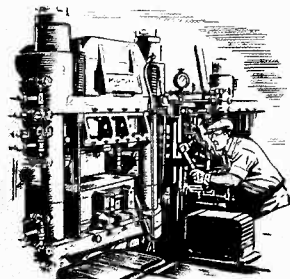

* MOLDING
 ... Rubber and bituminous plastics; and synthetic resin plastics... Beetle, Bakelite, Durez, etc.

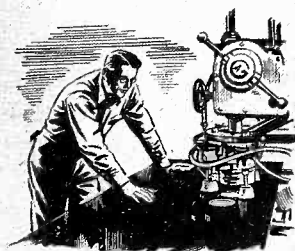

* FABRICATING
 ... Complete equipment for drilling, punching, sawing, turning, milling, etc.

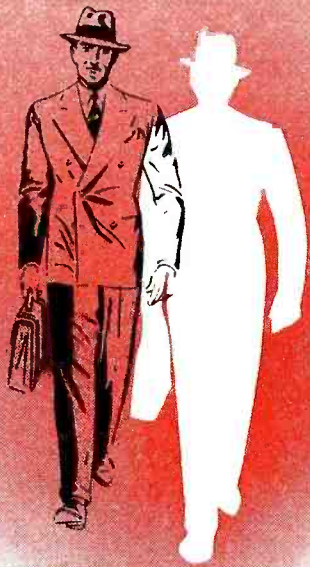

THE IMC ENGINEER

IS ON YOUR STAFF..

but not on your payroll

HEADQUARTERS FOR ELECTRICAL INSULATION

DIEFLEX

FIBERGLAS

MACALLEN

MANNING

NAT'L. FIBRE

PEDIGREE

PERMACEL

SILICONES

VARTEX

WEDGIE

... HE OFFERS A FULL LINE OF NATIONALLY KNOWN INSULATING MATERIALS

The IMC Engineer offers two services to help you solve electrical assembly problems:

1. A complete line of nationally advertised insulating materials.
2. Expert advice and engineering service on the best application of these materials.

Whatever your insulation problem, call in your nearby IMC Engineer. He is trained in the application of electrical insulation, and can usually suggest an answer from his experience and the complete line of products he represents. Every one of these products is superior in quality and designed for full satisfaction in application and service.

IMC PRODUCTS: Macallen Mica Products—Vartex Varnished Cloth and Tapes—Varslot Combination Slot Insulation—Varnished Silk and Paper—Fiberglas Electrical Insulation—Manning Insulating Papers and Pressboards—Dow Corning Silicones—Dieflex Varnished Tubings and Saturated Sleeveings of Cotton and Fiberglas—National Hard Fibre and Fishpaper—Phenolite Bakelite—Permacel Adhesive Tapes—Asbestos Woven Tapes and Sleeveings—Cotton Tapes, Webbing and Sleeveings—Pedigree Insulating Varnishes—Wedgie Brand Wood Wedges.

Representatives in:

DETROIT 2: 11341 Woodward Avenue
MINNEAPOLIS 3: 1208 Harmon Place
PEORIA 5: 101 Heinz Court

INSULATION

MANUFACTURERS CORPORATION

*CHICAGO 6
565 West Washington Blvd.

MILWAUKEE 2
312 East Wisconsin Avenue

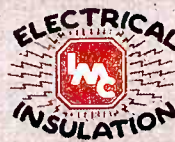

*CLEVELAND 14
1231 Superior Ave., N. E.

DAYTON 2
1315 Mutual Home Bldg.

*Local Stocks Available

TAX REVISION...

Can Make or Break American Business

IS THE American way of life—progress by private initiative—going to get a fair chance to demonstrate its superiority over all the challenging varieties of collectivism?

That's the real question before Congress as it confronts the long labor of remodeling the federal tax structure. What Congress does about taxes will come pretty close to making or breaking the U. S. A.

Today the tax colossus that sprawls across the national economy is unguided by any central nervous system. Its crushing weight comes down first here, then there, as the giant wobbles around, unguided by any central purpose except to grab as much as it can.

The central purpose of a tax system is simple. It should raise the necessary revenue without placing unnecessary fetters on enterprise.

As recently as 1929 federal taxes took only one dollar out of every twenty of national income. A loose-jointed and inconsistent tax structure was a nuisance then. But it wasn't serious.

Today the federal tax burden is the dominant element in the nation's economy.

Even if Congress succeeds in cutting \$6 billions out of President Truman's \$37.5 billion budget, federal taxes still will take about one dollar out of every five of the national income. And few Congressmen are hopeful enough to think that they can get the tax load below \$25 billion for any year that is in sight.

Drastic Budget Cuts Required

Indeed, to get the tax load down to \$25 billion, Congress will have to stop treating expenditures, like those for military purposes and veterans, as politically sacrosanct. Congress must scrutinize every item in the budget. Economy must go along with tax cutting or we shall end in bankruptcy.

Suppose that expenditures are slashed to the bone. Our taxes *still* will be so heavy that the way they are loaded on the nation's back will make a big difference in how well the nation gets along. That's something which the postwar boom has tended to obscure. It will become much clearer as this boom wears off. Then a remodeling of the federal tax system to remove its manifold obstructions to private enterprise will be of transcendent and obvious importance to everybody.

Tax Experts Agree

The remodeling will require political courage plus tax wisdom. Congress must supply its own political

courage. But it can lean on tax experts for tax wisdom. Fortunately, tax experts now agree on the necessary reforms—especially on those that will remove obstructions to business. How well the tax experts agree is shown in the charts on the next page, summarizing answers to a questionnaire on possible federal tax reforms. The questions were asked by the Department of Economics of the McGraw-Hill Publishing Company. The answers came from a broad cross-section of tax experts, including the authors of a considerable crop of books on postwar federal taxes and what to do about them.

The experts agree (see the charts) that double taxation of corporate dividends should stop.

They agree that the tax rate on corporate income (now 38 percent) should be reduced as rapidly as possible to the initial rate on individual income (now 20 percent).

And they agree overwhelmingly that it is desirable to let net losses be subtracted from net profits over a 5-to-6-year period in computing business income for tax purposes.

All three changes would stimulate corporate initiative and hence make jobs. Averaging business incomes would make new ventures attractive even though these ventures *might* result in early losses. Reduction of the corporate income tax would have the same effect. So, too, would the elimination of that highly discriminatory provision whereby corporate dividends are taxed first as corporate profits, and again when received as income by individuals.

Penalties on Incentives

Beyond these changes, there must be an end to tax penalties on *individual* initiative. Consider the enterprising business man whose income fluctuates markedly from year to year. Because of his enterprise he may pay, on the same income, twice as much federal income tax as the man who plays it safe for a steady income. That's because he can't average his personal income over several years for tax purposes. He can count on heavy taxation of his good-year profits with no chance for offsetting against them his bad-year losses. It is a case of heads you lose, tails the tax collector wins. Eighty-six percent of the experts agree that an income-averaging allowance for individuals is desirable.

Three-quarters of them also agree that tax rates at the top end of the individual income scale (now running up almost to 90 percent) should come down. In my judgment, the total tax should not amount to more than 50 percent to encourage business men to venture for high stakes.

Advocating tax relief for men in the higher income brackets—and particularly for management men—has been considered political suicide for more than a decade. Some members of Congress still hold that view. A Democratic Congressman from Michigan told an Illinois colleague who advocated cutting upper bracket taxes, "If you put that idea forward at home, you won't come back."

The Congressman has an even better chance of not going back if our economy bogs down. One of the best ways to bog it down is to keep the taxes that destroy business incentives and block enterprise—for example, the confiscatory rates which drive the people in the high brackets away from risk-taking.

To give the American system of individual enterprise a fair chance was clearly the mandate of November's election. To give it that chance, enterprising business men must have a chance to make large rewards—as well as the always-present chance to lose their shirts. Under present tax rates, they don't get a break.

Prevailing federal taxation throttles bold business enterprise in other ways. It fails, for example, to encourage research and rapid industrial modernization. It tends to siphon investment away from private enterprise, driving it into tax exempt state and local securities. (The experts agree almost to a man that such tax exemption must be eliminated.) The list of obstacles could be amplified.

Hit-and-Run Revision Disastrous

Most of the reforms needed to prevent the federal tax system from smothering enterprise would lower federal revenues, at least temporarily. Elimination of the double taxation of corporate dividends might lop off \$800 million. Dropping the corporate income tax from 38 percent to 20 percent might cut away as much as \$4 billion.

Because we can not avoid enormous federal expenses in the years immediately ahead, all badly needed reforms of the type to which this article is confined obviously can't be made at once. Also there are other tax reforms bearing on consumption which obviously should be weighted in an over-all program of tax revision.

But this is equally obvious: We should have a general design for tax revision which would line up all the necessary steps. Then we could get ahead with tax reductions as rapidly—and as sensibly—as revenue requirements and political courage would permit. Tax cutting may come piece-meal, but tax planning must not.

Through such a design we might discover that some decidedly beneficial improvements in the federal tax structure can be made at relatively slight cost. But to-day there's no way to be sure. No one in Washington with access to the information has even undertaken to make the necessary estimate.

Instead, federal tax revision continues to be a hit-and-run business—and a short-run political business. Take, for example, the proposal of a 20 percent tax reduction across the boards. There are virtues in such a proposal. But how they stack up beside many other extremely urgent needs for tax reform remains a mystery.







Congress must dispel such mysteries. Only in that

way will it do the job of converting our present jerry-built tax structure into a moderately safe abode for the American system of private initiative, sparked by adequate incentives.

EXPERT OPINION ABOUT TAX REVISION

TAX EXPERTS THINK WE SHOULD:

% Of Tax Experts Favoring the Proposed Changes

- | | |
|--|---|
| 1 Eliminate double taxation of corporation dividends which are now taxed as corporate profit and then again as individual income. |  92% |
| 2 Reduce corporation income tax rate (now 38%) as rapidly as budget needs permit until it equals the initial rate for individual incomes (now 20%). |  73% |
| 3 Provide for averaging business' taxable incomes over a period of about 6 years to allow for losses in bad years. |  97% |
| 4 Provide for averaging individuals' taxable incomes over a period of a few years so as to treat fairly those whose incomes fluctuate. |  86% |
| 5 Reduce upper bracket individual income tax rates to a maximum of 50% in the \$100,000 bracket and 75% in the million and over bracket. |  76% |
| 6 Treat capital gains, now taxed at a lower rate, like other income but provide full allowances for losses. |  64% |
| 7 Remove the privilege of tax exemption from all future issues of state and local government bonds. |  92% |

James H. McGraw, Jr.

President McGraw-Hill Publishing Company, Inc.



**hp 410A VACUUM
TUBE VOLTMETER
TAKES THE PLACE
OF 4 INSTRUMENTS**

**This single instrument
accurately makes most of the
important radio measurements**

4 PRECISION INSTRUMENTS IN ONE

VHF Voltmeter... Measures voltages from 0.1 to 300 volts at frequencies from 20 cps to 700 mc. Frequency response flat within 1 db over entire range. Extremely low input capacity — approximately 1.3 uuf — and very high shunt resistance means most circuits can be measured without detuning or loading. Is a convenient voltage indicator up to 3000 mc.

Audio Frequency Voltmeter... Measures voltages from upper limits of audio spectrum down to 10 cps. 6 ranges full scale: 1, 3, 10, 30, 100 and 300 volts. Effective input resistance is 10 megohms. Accuracy is within $\pm 3\%$ on sinusoidal voltages.

D-C Voltmeter... Measures voltages from 1 to 1000 volts — full scale sensitivity — in 7 ranges. The input resistance on all ranges is 100 megohms, so circuits under test are never appreciably loaded, and accurate

readings can be obtained even on circuits of high impedance. Polarity reversing switch saves time.

Ohmmeter... Measures resistances from 0.2 ohms to 500 megohms in 7 ranges; with mid-scale readings of 10, 100, 1000, 10,000, 100,000 ohms, 1 and 10 megohms.

Check These Added Advantages... Small diode a-c voltage probe reaches inaccessible components. Probe capacity is approximately 1.3 uuf. Removable probe head provides

short, direct connection to diode, makes possible uhf response, and facilitates use of adapting connectors in making special or uhf measurements. Rugged 1-mil meter has knife-edge pointer, 5 easy-to-read scales, and cannot be damaged by accidental overload. Two convenient switches select 27 measurement conditions. Specially-designed circuit minimizes drift caused by line-voltage variations, warmups, and tube changes. Constant readjustment is not necessary.

This *hp*-410A Vacuum Tube Voltmeter is the ideal general-purpose instrument for important measurements in the development, manufacture, or servicing of radio equipment. For full details and shipping information, write or wire today. Hewlett-Packard Company, 1381A Page Mill Road, Palo Alto, California.

hp laboratory instruments
FOR SPEED AND ACCURACY

Noise and Distortion Analyzers	Wave Analyzers	Frequency Meters
Audio Frequency Oscillators	Audio Signal Generators	Vacuum Tube Voltmeters
Amplifiers	Power Supplies	UHF Signal Generators
Square Wave Generators	Frequency Standards	Attenuators
		Electronic Tachometers

BUSINESS BRIEFS

By W. W. MacDONALD

BRADLEY COPPER OXIDE RECTIFIERS

NEW "COPROX" RECTIFIER FOR PORTABLE RADIOS

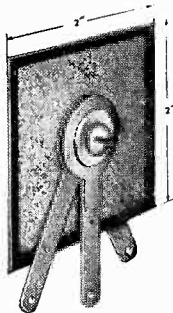

Small, light-weight but rugged is the new copper-oxide rectifier developed by Bradley especially for portable radio low voltage battery charging.

Rated at 1.5 amperes continuous current, this newest addition to the Bradley "Coprox" line offers a permanent, trouble-free, full wave rectifier. Priced for production use, its small size and versatile mounting provisions adapt it to limited space requirements.

Illustrated literature, available on request, shows more models of copper oxide rectifiers, plus a line of selenium rectifiers and photocells. Write for "The Bradley Line."

BRADLEY LABORATORIES, INC.

82 Meadow St. New Haven 10, Conn.

Commercial Shipping Interests have been quietly trying out radar units designed expressly for their use. At present operating under one-year experimental licenses, they are encouraged by the news that tickets for regular operation will probably be issued sometime this summer on a five-year basis, and by the generally favorable experience they have had with initial equipment.

As near as we can tell by checking with the half-dozen manufacturers most active in this field it appears that about 85 sets have been installed aboard American vessels, chiefly on the Atlantic seaboard and in the Great Lakes, a little more than half of these going out on consignment as a market and equipment test and the balance being outright sales. Additional orders on hand probably total 200 and it looks like several thousand could readily be sold in the next three or four years.

Television Antennas have been banned by 84 percent of the New York City apartment-house owners so far contacted by ELECTRONICS in a survey which is continuing as this issue goes to press (details on p 88). Even at this early stage of the game it is evident that the concerted move by realtors to avoid rooftop ratnests will have considerable effect upon the video receiver market since the figure given above covers 344 buildings housing 14,810 tenants.

C-R Tubes cost more than any other component in a television receiver. Anything which tends to reduce their price can have a marked effect on overall receiver cost. And it seems that several things which will ultimately do this are on the way, although they are unlikely to make themselves felt immediately due to other cost factors which set manufacturers originally underestimated.

For one thing, an order for envelopes large enough to initiate steps in the direction of true mass production has been placed with one glass-blower. For another, we

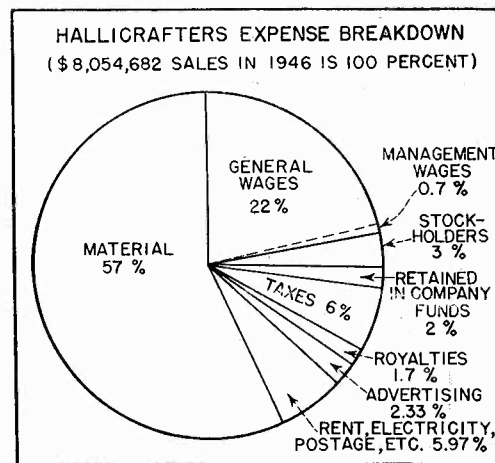

hear that certain extremely rigid specifications to which glass is blown could probably be relaxed without visibly affecting the picture and that this would materially reduce the number of envelope rejects.

Television's Attractiveness is exemplified by a story sent in by one of our Hollywood friends. It seems that a certain studio asked a certain receiver manufacturer to supply several dummy sets for use in a new picture. No piker, the manufacturer shipped working models. A couple of weeks later, when the sets were wanted, they had all disappeared from the prop room.

Crosslicense Agreements have been entered into between Philco and RCA, Westinghouse and General Electric, on an equal basis.

Among the major developments enabling Philco to get under a common patent coverlet with such big bedfellows is its single-stage f-m detector, wideband amplifiers for television, electromechanical record-changer and pickup designs, and some cute technical tricks in connection with radar. The contributions of the other three companies to the agreement are well and widely known.

Dynamotor Deliveries are slowly improving but production still lags 8 to 10 months behind orders.

Primary reason is the unexpected windfall of business from new services such as taxicab radio, superimposed upon a 4-year back-

UHF tetrode



Eimac 4X150A Power Tetrode	
Electrical Characteristics	
Heater voltage	6.0 volts
Heater Current	2.7 amps.
Grid-screen amplification factor (approximate)	4.
Direct Interelectrode capacitance (typical)	
Grid-Plate	0.02 μf
Input	12.0 μf
Output	4.6 μf
Maximum Ratings	
DC Plate voltage	1000 volts
DC Plate current	200 ma.
Plate dissipation	150 watts
DC Screen voltage	300 volts

The 4X150A, a new Eimac tetrode, extremely versatile—diminutive in size, will fill the bill in all types of application and at all frequencies up to 500 mc. Performance characteristics include—high transconductance, low plate voltage operation, low grid drive, high plate dissipation, and traditional Eimac-tetrode stability. Physical features include:

- A Low inductance grid lead.
- B Close element spacing for UHF and high transconductance.
- C Screen grid, mounting, and ring connector design effectively isolates input and output circuits.
- D Heater isolated from cathode.
- E Indirectly heated cathode.
- F Low inductance cathode terminals, (four separate paralleled pins).
- G Controlled primary and secondary grid emission, by specially processed grids.
- H New molded glass header, precision pin alignment.
- I Forced air cooled (vertical finned).
- J Simple installation, adaptable to standard loctal socket.

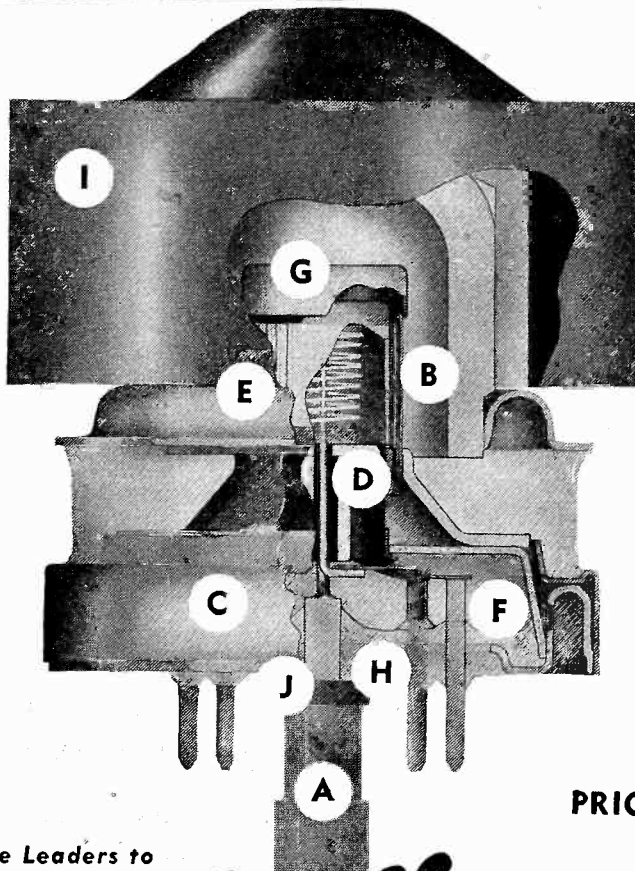

PRICE, \$31.00

Follow the Leaders to

Eimac
REG. U. S. PAT. OFF.
TUBES

The Power for R-F

You will find the 4X150A suited to your requirements, whether for wide-band low-efficiency service such as television video and audio or conventional application. For further information on this new, versatile, Eimac tetrode, type 4X150A, write to:

EITEL-McCULLOUGH, INC.
1451 San Mateo Avenue
San Bruno, California

EXPORT AGENTS: FRAZAR & HANSEN, 301 CLAY ST., SAN FRANCISCO 11, CALIFORNIA, U.S.A.

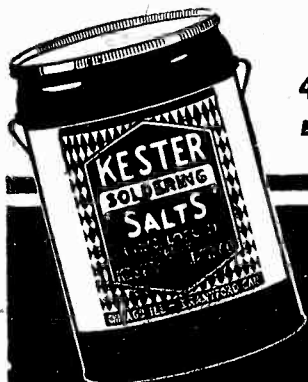

Photo courtesy Bell Aircraft Corporation

Here's Fluxing Efficiency For SOLDER SECURITY

KESTER FLUXES

- Your soldering job can be only as effective as the flux you use. Don't take chances on solder failure because the flux isn't suited to the job. Be sure with Kester!
- Nearly half a century of practical experience is behind the development of Kester Fluxes. Drawing on that experience, Kester engineers have developed a vast range of flux formulas covering every possible soldering requirement.
- Various types of seams, spot soldering, electrical connections, sweating operations—all have their own special requirements, all their own *special fluxes*.
- In any form—salts, paste or liquid—you can count on Kester Fluxes to form solder bonds that hold tight and provide top product performance.
- To be sure of the right flux on every soldering operation, consult Kester engineers. They're soldering specialists, and there is no obligation.



KESTER SOLDER COMPANY

4204 Wrightwood Avenue, Chicago 39, Illinois

Eastern Plant: Newark, N. J.

Canadian Plant: Brantford, Ontario

KESTER

Solder Fluxes

STANDARD FOR INDUSTRY

log built up among more conventional customers. Secondary reason is limitation of production below full plant capacity by shortages of magnet wire, silicon steel, yoke material, ball bearings, and bolts.

Most of the companies that jumped into the business during the wartime emergency have already retired from it, believing that the productive capacity of old-time manufacturers will be ample as soon as the material situation clears up. And some of the specialists have diverted a little of their energy from dynamotors to new products in heavy demand. But these two factors are to only a limited extent responsible for the shortage.

Electronic Consultants are to be listed in the editorial section of our buyer's guide and directory, an extra number that comes out around mid-June between two regular issues of the magazine. In the process of collecting their names, addresses and other data, which continues at this writing, some interesting statistics are being developed:

Of the 250 consultants replying to our questionnaire so far, 24 percent specialize in communications, 38 percent concentrate on industrial applications, and the remaining 38 percent handle both types of work. Patent matters are interesting to 37 percent.

Hotel Radio Business is one of the markets to watch this year. Several manufacturers are injecting new life into it by offering coin-operated sets. And a firm selling centralized systems suggests that the availability of wiring over which fire alarms may be sounded in each room may help stave off pending legislation that would necessitate the maintenance of special safety crews, at considerable expense to the hotels.

More Men, more money, and more room are three pressing Patent Office needs. Patents are being applied for in greatly increased number and are being issued at about half the pre-war rate. Facilities for handling them are about as adequate as the kit of

tools that comes with a modern car.

At the close of business in 1946 there were 3,699 patents identifiable as radio on the hook awaiting action, and another 1,244 on telegraphy and telephony. It is difficult to identify electronic apparatus listed in other categories but there are obviously many additional thousands of applications on hand covering navigational gear, industrial equipment and medical devices using tubes, not to mention instruments of all kinds, electrical apparatus and many other things we think of as allied products.

Surplus Equipment is sometimes a bad buy at any price and no substitute for commercial gear designed expressly for a job. A case in point is recent interference with instrument-landing systems by f-m broadcast stations, which turned out to be the fault of surplus receivers in the aircraft.

Miniature Panel Instruments were built in quantity for the military during the war and this market will continue although not, of course, at the same level. Such instruments are useful in certain Army, Navy and Air Force gear which must be ultra-compact.

Commercially, instruments 1½ inches or less in diameter appear to have a good but somewhat specialized market. Current research indicates that they are in demand for use in portable units which really must get down to minimum size, photographic exposure meters and test equipment for hearing aids being typical examples. Volume comparable with that achieved by more conventional larger varieties seems unlikely, chiefly because of the cost factor. As in the manufacture of watches, small size does not necessarily mean small cost.

Talking With A Group of engineers working on a temperature control problem the other day we picked up a remark worth repeating. We won't vouch for its authenticity, but it does seem of more than academic interest. The remark: "Physically and mentally men and women are satisfied at temperatures 1½ degrees apart."

FOR POSITIVE CONNECTIONS

connect with

Cannon Plugs

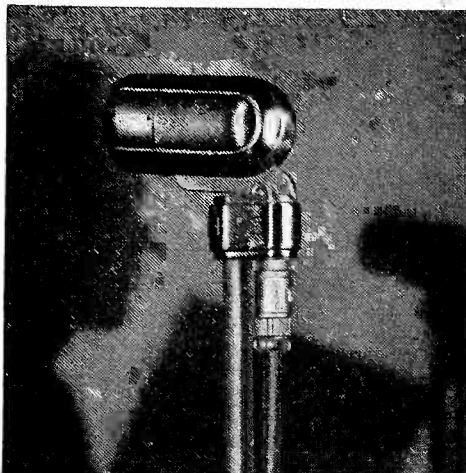

Turner "211" Mike with steel shell "XL" plug. Special adapters are required to re-convert these mike receptacles to "XL".

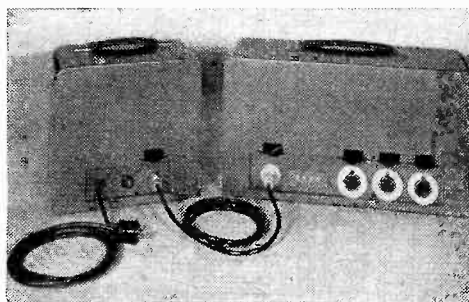

Raytheon's 3-channel Remote Amplifier and power unit uses two types of Cannon Plugs: "X" and "P". Three receptacles on amplifier at right are P3-13.

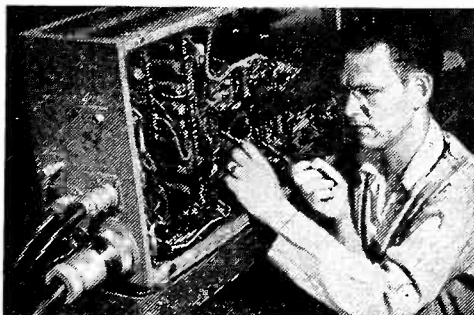

Rear end of RCA modern television monitor and control unit. Four types of Cannon Plugs are used in this unit: "TQ", "P", "K" and "FMR".
—Don Lee Television photo.

The connectors shown above are summarized with list prices in new C146A Condensed Catalog. Write to Dept. D-120 for a copy. Types "P", "X" and "XL" are also available direct from more than 125 leading electrical jobbers.

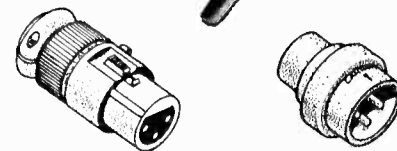

Type XL-3-11SC (\$2.80 List)
Type XL-3-50N (\$1.30 List)

One of three types of adapters made by Cannon Electric for converting microphones over to Cannon "XL" connectors when original plug installation is of another manufacture. The steel shell plugs not only have an integral cable clamp (5/16" Dia.) but are practically unbreakable.

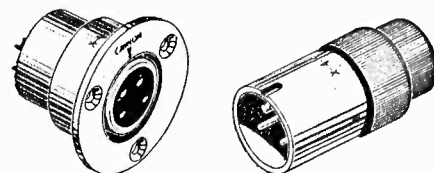

Type X-4-13 (\$3.25 List)
Type X-3-12 (\$1.25 List)

The "X" series of light plugs are made in zinc with bright nickel finish and have three available insert arrangements: 1 to 4 contacts for No. 14 and No. 16 wires. Friction-hold coupling. Cable entry 9/32" with gland nut and bushing.

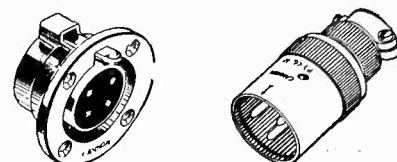

Type P4-13 (\$4.55 List)
Type P3-CG-12 (\$2.50 List)

The Type "P" Series has been standard on many types of quality electrical equipment for many years. It includes a wide variety of shell styles in both plugs and receptacles and six different insert arrangements from which to select two to six 30-amp. or eight 15-amp. contacts. Two cable entries 9/32" and 25/32".



CANNON ELECTRIC DEVELOPMENT COMPANY

3209 Humboldt Street, Los Angeles 31, California

Canada & British Empire — Cannon Electric Co., Ltd., Toronto, Ontario • World Export Agents (excepting British Empire) Frazar & Hansen, 301 Clay St., San Francisco 11, Calif.

*Nickel after nickel...
hour after hour...*

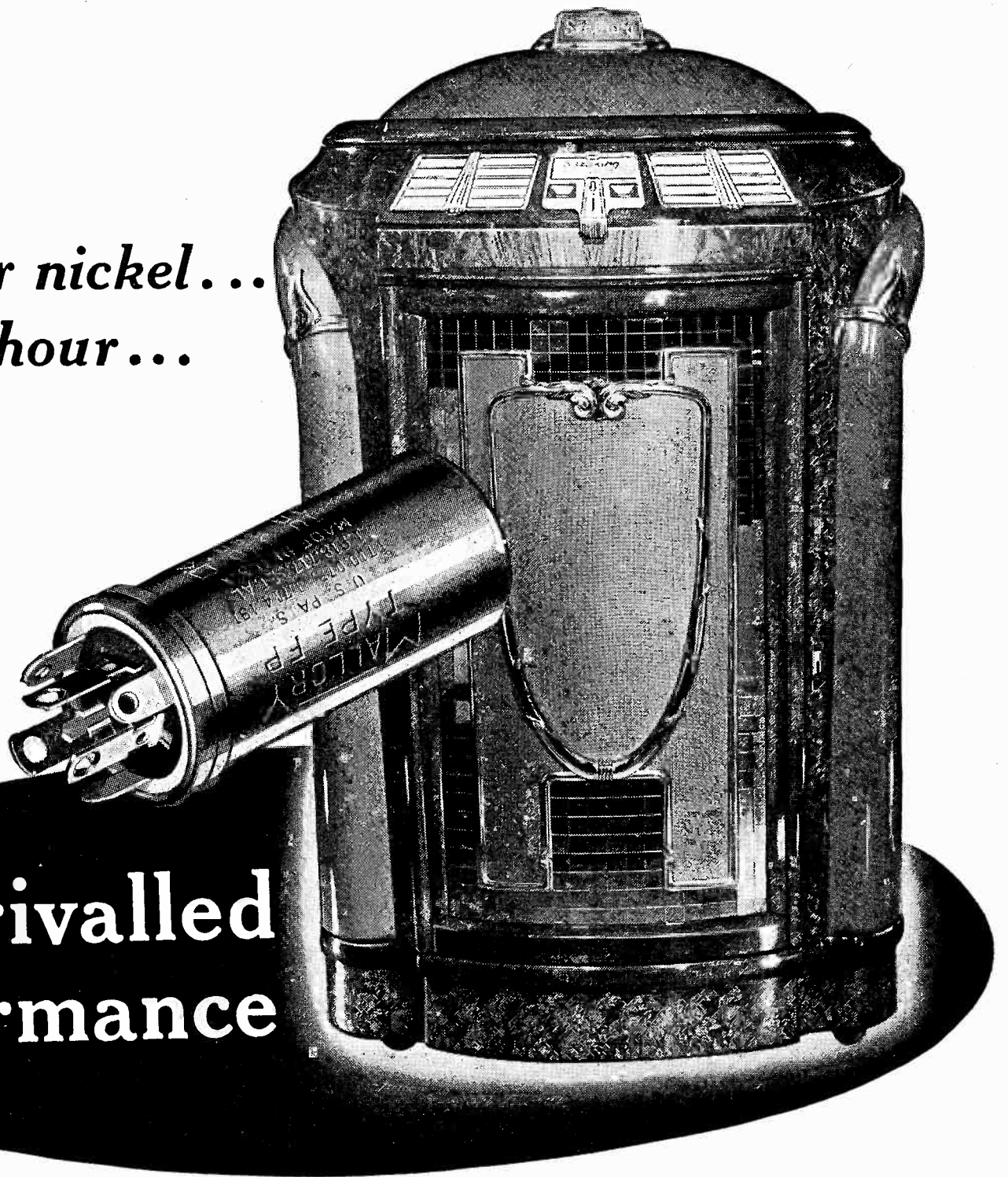

Unrivalled Performance

Perhaps the world's toughest job for an electrolytic capacitor is found in the familiar "juke box." Necessarily rugged in itself, the "juke box" requires sturdy components. High temperatures, heavy ripple currents, high voltages and continuous operation impose a tough set of conditions.

Mallory FP capacitors are famous the world over for their ability to stand up under severe punishment. That's why, in so many thousands of "juke boxes," like the popular J. P. Seeburg Co. instrument pictured, Mallory FPs are standard equipment. No other capacitors perform so dependably—*nickel after nickel, hour after hour, year after year!*



Everything you want to know about Mallory electrolytic capacitors—types, sizes, electrical characteristics—even data on test measurements and mounting hardware. Write today for a free copy.

P. R. MALLORY & CO. Inc.
MALLORY CAPACITORS
(ELECTROLYTIC, OIL and WAX)

P. R. MALLORY & CO., Inc., INDIANAPOLIS 6, INDIANA



CROSS TALK

► **SUBAQUEOUS** . . . A young lady formerly with the MIT Radiation Laboratory tells us the girls had a word for Ted Hunt's Underwater Sound Laboratory at Harvard. Passing this highly secret establishment on their way to work, it was their custom to murmur "blub, blub, blub."

► **CIRCUS** . . . It's time, we feel, to register heavy protest over the six-ring circuses conducted currently by our friends in the IRE and the National Electronics Conference. The straw which broke our back was the 1947 IRE National Convention just concluded in New York. This melee presented 124 papers in 25 sessions, running four abreast in five meeting places in two buildings, morning and afternoon for three and one-half days. This is a load well beyond the capacity of Bunyan and the Blue Ox, let alone any reasonably good insurance risk in the profession of electronics.

To the familiar hazard of multiple sessions, which for years has prevented hearing all the papers one might reasonably want to hear, was added this year a fast sprint from the Commodore to the Grand Central Palace. No one, including the committee chairman, was happy about it.

Within the framework set up, the program committee did a good job in separating papers into sessions on particular and, hopefully, non-conflicting subjects. But the segregation just didn't work. The members of our fraternity are still young enough to be interested, vitally and definitely, in matters not directly connected with their particular field of work. The broadcast engineer has a bread-and-butter interest in antennas, propagation, television, f-m, recording, and power tubes. He has a vital interest in nucleonics, aids to navigation, radar, microwaves, pulse-time systems, and his own professional status, all of which formed sessions in hopeless conflict with each other and with his primary interests. And similarly for all the other types of engineers in our business.

The only answer, it would seem, is a firm resolve on the part of program committees to hold the number of papers down at all costs. Papers of lesser importance must make room for essential and vital ones; papers on subjects previously presented in print or at other meetings must be weeded out. Only thus can the technician of varied interest (and who is not?) overcome his present frustration.

► **THANKS** . . . Recently we were shown an r-f signal generator made during the war by a Swiss firm for German use. Electrically very similar to one of the outstanding American designs, this device shows evidence of a fiendish ingenuity in behalf of the Allied cause. Where a straight shaft might have sufficed, a tube socket was placed in line with the shaft and the socket bypassed mechanically by bevel gears. On the tuning dial are engraved thousands of microscopic divisions, visible only under a strong glass, and having no discernible use. In dozens of similar instances, unnecessary man-hours were poured into the design, thus assuring against high-speed production, and hindering the ultimate user. The bad mechanical engineering was so cleverly contrived that it must have been an intentional effort to obstruct the German war machine. To the unknown Swiss designer, and to countless others like him both in and out of Germany, we owe thanks.

► **PPI** . . . The wheels within the wheels of electronic endeavor never fail to amaze. Now comes word from MIT that work is underway on a plan position indicator, originally developed to map radar targets, to map electric potentials on the human skull. These tiny impulses (1 to 50 microvolts) are useful in determining the presence and position of brain tumors. Those working on it say the job is a tough one because the voltage is so small. As in radar, the problem is to lick the noise. Our guess is that the noise will be licked.

The TELEVISION

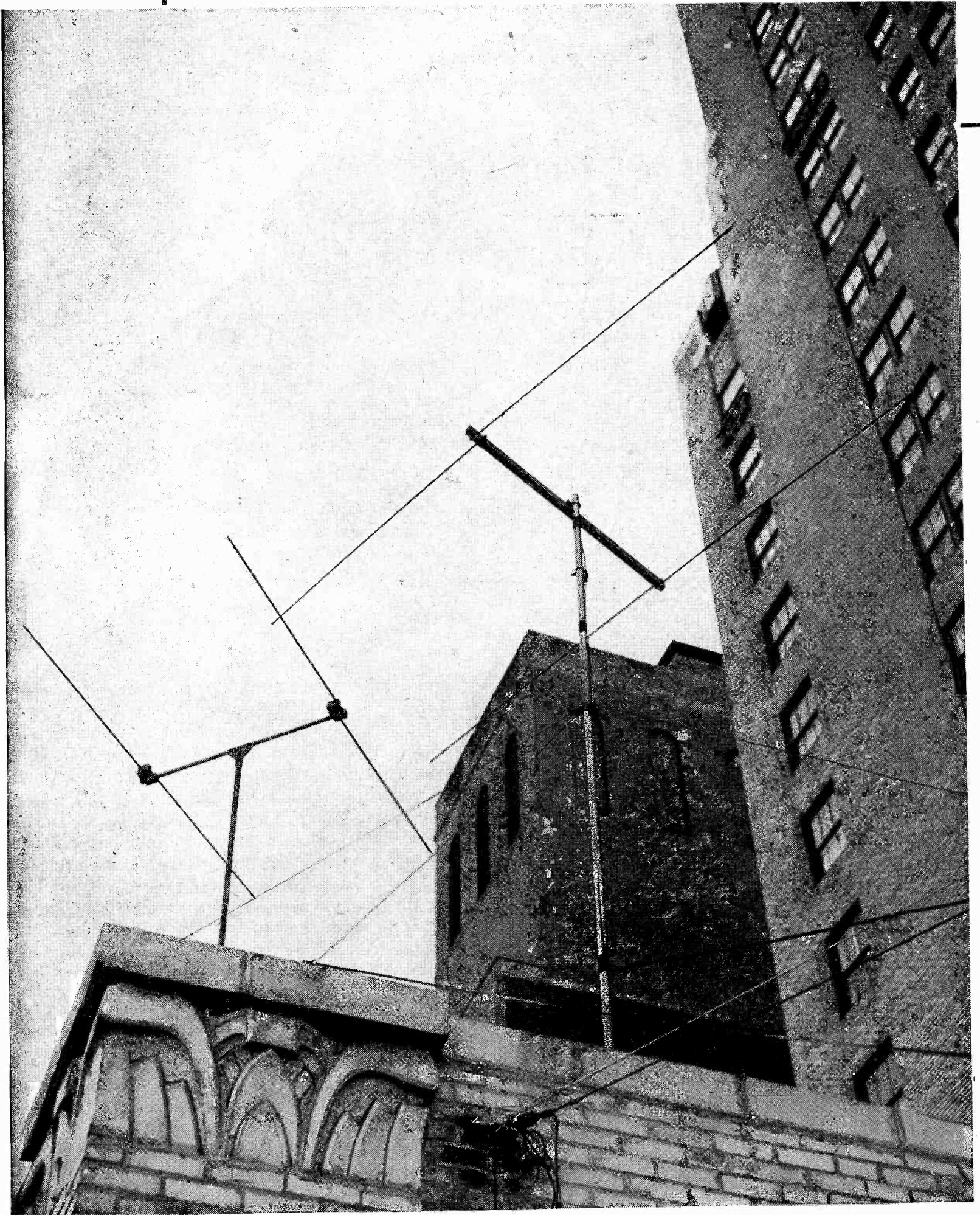

ANTENNA PROBLEM

Organized move by New York landlords, forbidding individual outdoor antennas in apartment houses, threatens to choke off large slice of video market. Thorough analysis of master antenna systems and installation costs needed to clear atmosphere

THE RECENT PROHIBITION against erecting individual television antennas, imposed on the tenants of more than 100 apartment buildings in New York City, has brought into sharp focus a problem long recognized but not squarely faced. Television engineers have been aware for many years that the erection of a number of antennas, within an area of a few tens of square wavelengths, would permit interaction between receivers generally injurious to reception. Work on master television antenna systems which would provide multiple signal sources from a single antenna had begun, but had been neglected in view of the more urgent problems.

The industry was shocked when, early in February, the Wood Dolson Company of New York served notice on several thousand tenants that the apartment owners would not permit the installation of television sets "until such time as some scientific method has been developed for a master television aerial." The reasons given for the action are compelling: even assuming that it was a physical possibility to erect individual antennas for even half the families in a 50-family apartment, such an installation would be unsightly and dangerous. Since it would be unfair (and possibly illegal) to restrict some tenants while allowing the first comers to have service, the only prudent action was to prohibit all installations from the start, until a system was installed capable of serving all tenants on equal footing.

The first reaction by the television industry was to form a committee in the Television Broadcasters Association, under the chairmanship of Ernest A. Marx, to organize all TBA members and affili-

ates to study the problem and advise on procedure. The committee's first action was a request to the apartment owners to rescind or modify the order, at least temporarily, while the problems of the master antenna system were being worked out, and to allow the service to proceed while few tenants were involved. At the time of writing, however, this request had not been granted.

There was general agreement that, even if installations were permitted at present, the problem would have to be faced. Most apartment sites are subject to multipath interference, which can be minimized by locating the antenna at a critical position where reflected components cancel one another. The subsequent erection of another antenna within a wavelength distance would set up additional reflections and destroy the critical adjustment of the first. The mutual impedance between such close-spaced antennas might also destroy the impedance match to the transmission lines of each, and it would supply a closely coupled path through which even minute reradiation from the local oscillator of one receiver could cause interference to the other.

The master antenna has many ob-

vious advantages. Installed by experts, with a reasonably free choice of location on the roof, it could be positioned to secure the best possible reception. The absence of other antennas would make it feasible to install several units, perhaps a separate antenna for each station within range, and to optimize reception from each. The disadvantages are, first and foremost, cost, particularly cost of installation in existing buildings, and second, technical problems related to original equipment costs. The outlet installed in each apartment should provide for all existing stations and permit ready additional service as new stations appear. It must provide for a wide variety of impedance levels, and balanced as well as single-ended terminations. It must be reasonably unilateral, to avoid reaction on other units, and the level of signal provided should be high enough to mask interference arising from other connected units.

A survey of the half dozen firms now engaged in the design of master systems revealed some doubt as to the ability of existing systems to cope with all these requirements, but agreement that answers can be found quickly and at reasonable cost.

NEEDED—AN EXCHANGE OF INFORMATION

The television industry and the realty interests have no fundamental quarrel. Television needs the apartment house audience. Landlords know that sooner or later an apartment without a television antenna connection will be as hard to rent as one without a refrigerator.

The first step in solving this mutual problem is an exchange of pertinent facts. Engineers can tell landlords the facts about indoor antennas, about master antenna systems, about costs of running conduit and cable. Landlords can tell engineers how much the traffic will bear, and who can be persuaded to pay how much for service.

The editors of *ELECTRONICS* are currently surveying both groups. First findings will be published in the next issue.

EXPERIMENTS

Audience reaction to reproduced music, from both live and transcribed sources, is tested with a high-quality audio system. Results of tests and technical data on the design of the stereophonic equipment used are given

QUALITY in sound reproduction has long occupied the attention of broadcasters, engineers, musicians, and radio manufacturers; in fact, just about everyone in the radio industry has had his say on the subject.

Until recently the expressions of opinion were subjective and to that extent added little to the real solution of the problem. Only limited attempts have been made to apply scientific methods and for the most part the question has remained an academic one.

In practice, the telephone people and the set manufacturers settled the problem by either rationalizing or subscribing to convenient doctrines based upon doubtful evidence. The result, insofar as the present state of a-m radio is concerned, is a general lack of high-quality reproduction for listening enjoyment. To discuss the responsibility for this state of the medium is not the purpose of this article. However, it is apropos to point out that the advent of f-m has brought a renewed interest in the problem of quality sound reproduction.

The engineering department of McClatchy Broadcasting Company has been trying to secure objective data that might throw some truth on the subject. We feel that our

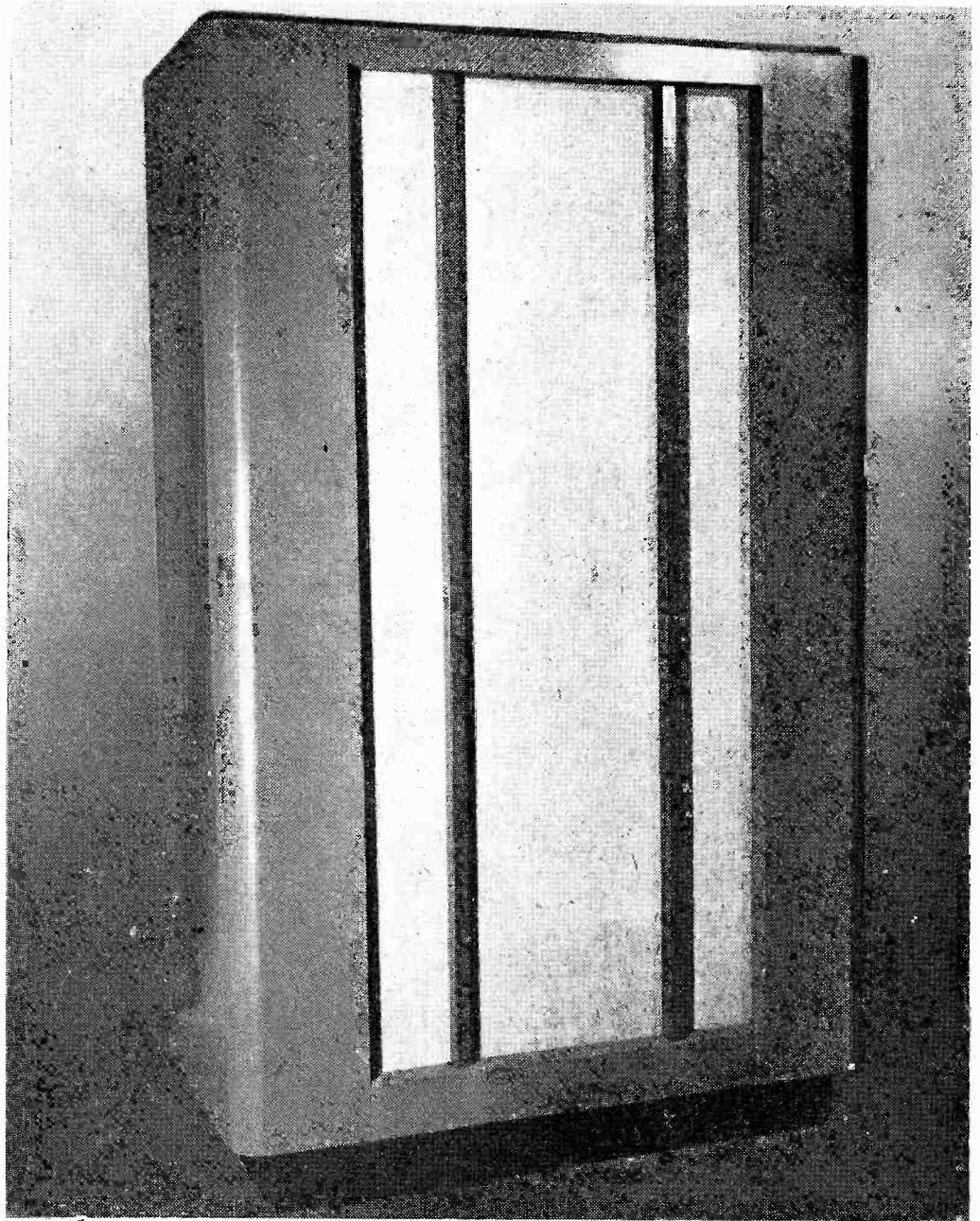

Front of speaker console used to obtain audience reaction to reproduction of live and transcribed music

MORE TESTS NEEDED

Much of the mail to the editors of *ELECTRONICS* concerns sound reproduction and the various technical factors involved. Objective analysis of listener reaction to present equipments, the tests discussed in this article being a good example, is sorely needed for further progress of the art.

findings, although by no means complete, are of such nature as to represent an original contribution.

Practical Approach

The common attitude seems to be that the average listener is a queer animal who doesn't appreciate quality in reproduction—in fact, his

sense of discrimination is so poor that he can't even recognize the good from the bad. It is maintained that Mr. and Mrs. Listener, when left to their own devices, turn up the bass content to booming proportions and consider the result the ultimate in high-quality listening.

We refused to subscribe matter-of-factly to this doctrine for it ap-

IN LISTENING

By **NORMAN D. WEBSTER** and **FRANKLIN C. McPEAK**

Technical Director

*McClatchy Broadcasting Company
Sacramento, California*

Special Project Engineer

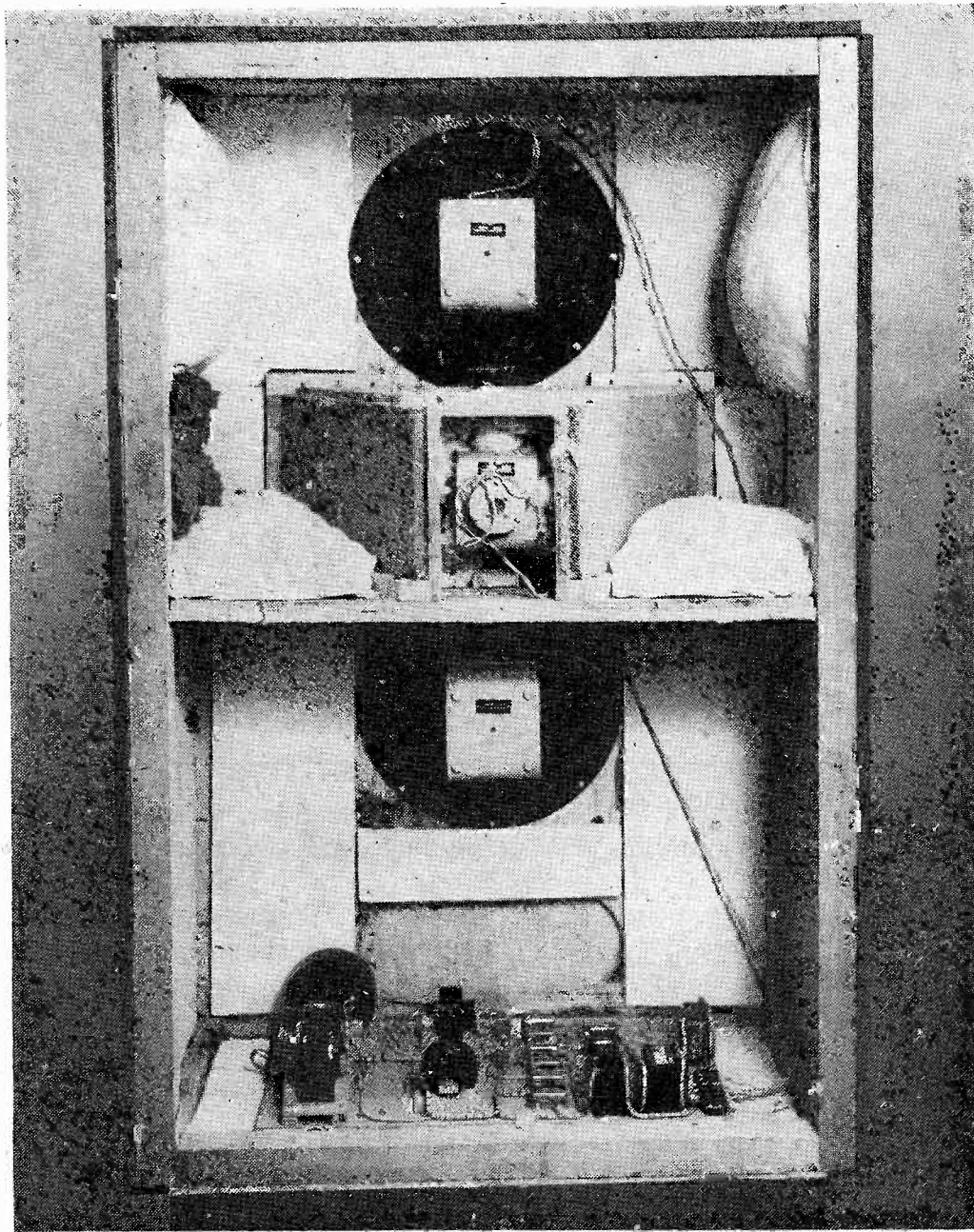

Back of console housing three loudspeakers. The cover has been removed to show the interior

peared quite possible that the listening public might appreciate and prefer quality reproduction if it were made available. Actually, the position of the bass control has little influence in the discussion since in any position quality reception is generally well-nigh impossible.

There are very few radio receiv-

ers constructed with an eye to quality reproduction and those that are cannot realize their potential since the telephone lines of the networks exclude quality before the receiver is even reached. The simple fact of the matter is that there just isn't much quality listening available; the best is generally a poor compromise. This situation may explain

in part why good musical programs never have been particularly popular on the air whereas a love of music in its original form is almost universal in man.

Amplifiers and Speakers

Our approach to the problem was the construction of a sound system that would result in as near perfect reproduction as possible. Once possessed of such equipment we would demonstrate it to the public and record their reaction. Our test groups, unlike many others, would not consist of just engineers or just musicians, but would be composed of a general cross-section.

The reproducing system finally developed for use in our testing project is worthy of description. The amplifier is particularly outstanding as it has the following operational characteristics:

Frequency response:	20—17,000 cycles ± 1 db
Power output:	40 watts into a load between 850 and 1200 ohms
Distortion:	RMS distortion less than 1 per- cent at 40 watts
Noise level:	—70 db below full output un- weighted
Internal impedance:	Effective output impedance less than 15 ohms with 850-ohm load
Load impedance:	500—2,000 ohms optional. Meas- urements made with 850-ohm load

Many individual loudspeakers and combinations of loudspeakers were tested before we arrived at our final arrangement. This consisted of three units with crossovers at 225 and 800 cps. The low-

frequency speaker operates from 40 to 225 cps, a medium-frequency speaker covers the range from 225 to 800 cps, and a high-frequency speaker covers 800 to 12,000 cps.

The two low-frequency ranges were covered by 15-inch cones of good efficiency, while the range above 800 cps was covered by a small multicellular tweeter.

These loudspeakers have handled their assigned frequencies without the generation of sub-harmonics, production of noticeable cross-modulation components, or rattles. The console to house this combination was an engineered structure, solidly built, well insulated and properly dimensioned to prevent appreciable cabinet resonance effects.

The complete system was tested using live talent at the microphone. The quality of reproduction was better than even we had anticipated, for there was no distortion that the trained ear could detect. Satisfied that our equipment was capable of doing the intended job, we added one major improvement, the use of two complete systems. This gave us an audio perspective combination capable of reproducing those subtle characteristics of dimension, the final touch of realism.

In our preliminary privately conducted tests we used a string ensemble and an organ. The results were not only comparable in every way to the original, but at times seemed superior. It may seem paradoxical to claim that the reproduction could surpass the original, but

it is really quite feasible. It was not a matter of adding anything not in the original, but rather a matter of making it possible to hear everything in the original. For example, the concert-goer, although seated

in the room where the music is being played, may miss much of the output of certain instruments simply because of the relation of his seat to those instruments. With the two-channel microphone system we

Reproduction Tests

TABLE I

QUESTION: In your opinion, how does the quality of audio perspective reproduction compare with live music?

Answers	Sacramento Tests			Fresno Tests		Total
	1	2	3	4	5	
Superior.....	52%	43%	30%	67%	45%	46%
Equivalent.....	39%	57%	70%	33%	45%	50%
Inferior.....	9%	10%	4%

Total Cases: 74 persons

TABLE II

QUESTION: In your opinion, how does the quality of audio perspective reproduction compare with the juke box?

Answers	Sacramento Tests			Fresno Tests		Total
	1	2	3	4	5	
Superior.....	100%	100%	100%	100%	100%	100%
Equivalent.....
Inferior.....

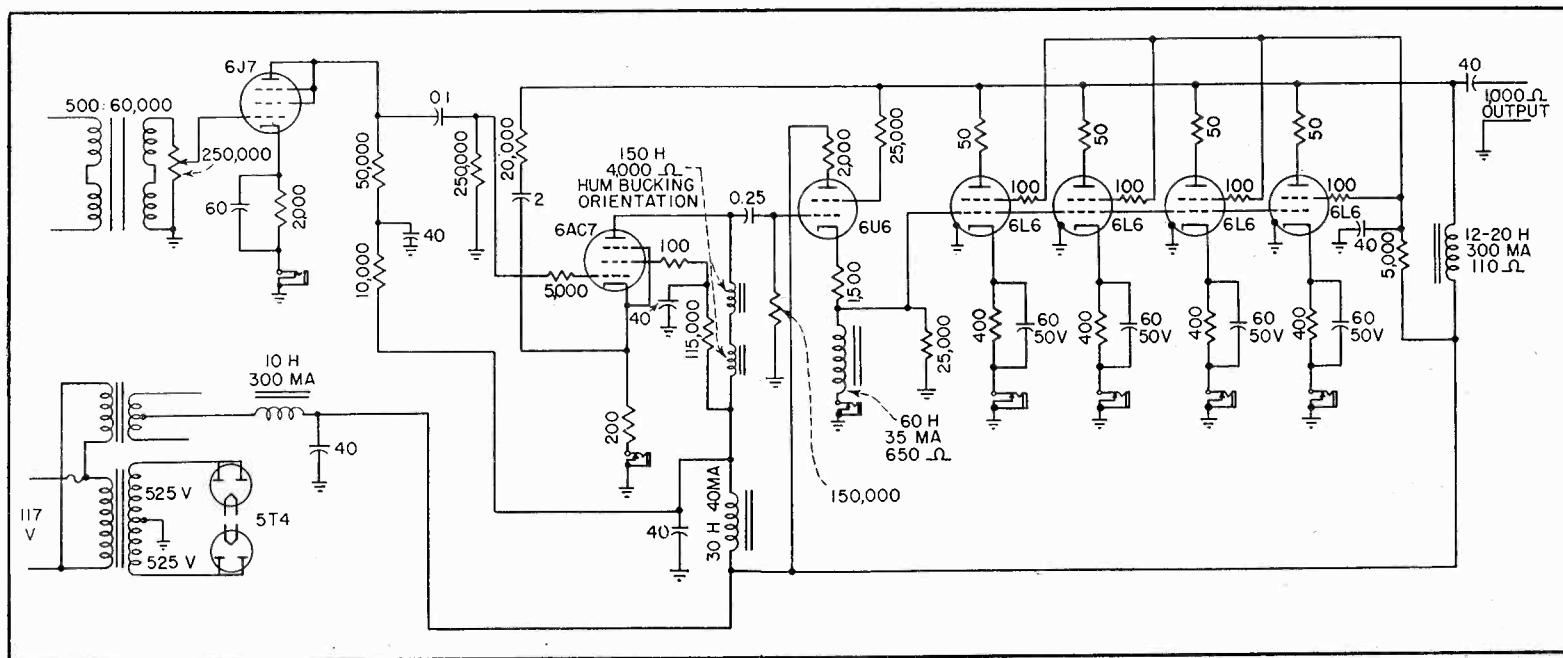

Complete circuit of amplifier designed for the listening tests

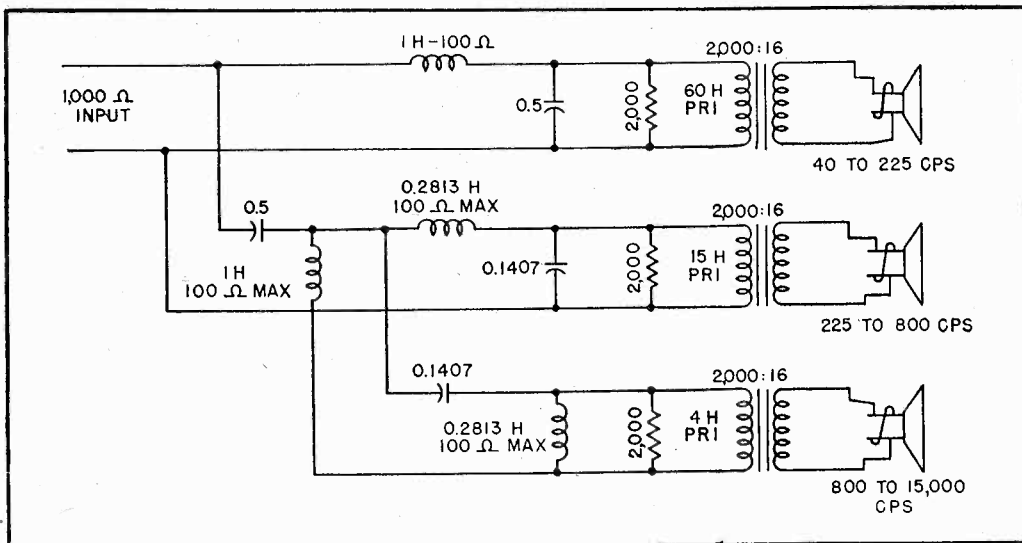

Speaker circuit arrangement and values of components in crossover networks

are able to spot our microphones so as to make all the instruments audible and to achieve pleasant balance. Our initial impression of this effect was later borne out by many unbiased observers.

Details of Tests

The next step was to call in the public and determine their reaction to quality reproduction. Would they recognize the superiority of our system or would they be unaware of this new listening experience? If they were aware of a difference would they like what they heard?

Three demonstrations were held in Sacramento and two in Fresno. The group consisted of merchants, hotel owners, club managers and other business people invited to attend the demonstrations. Admittedly the selection was not by random techniques and hence we cannot project general conclusions from these groups. Nonetheless, the results are interesting and thought provoking, especially when it is realized that many of these people are constantly listening to live music.

In each instance the program was furnished by live talent and with one exception consisted of an organ solo, a piano solo and popular music by a six-piece local band. The exception was the second Fresno meeting where the program was made up of a piano solo, music by a string ensemble, and by a ten-piece dance orchestra.

In Sacramento, the program originated in one studio and was carried by wire to the demonstration room. For the first Fresno experi-

ment the program again originated in Sacramento and was carried by high-quality telephone lines to Fresno, 175 miles away. In the final Fresno demonstration, the music originated five miles from the demonstration studio. Despite the changes in program material and the use and non-use of telephone lines, the reactions of the various groups, as recorded by individual questionnaires, was quite similar. Table I shows the results obtained.

It is a real tribute to the reproducing system that 46 percent of the auditors considered the reproduced output superior to live music and the fact that 96 percent believed the result to be at least the equivalent of live music is testi-

mony that these people did recognize quality. They seemed to recognize that what they heard was endowed with the beauty of live music despite the fact that the booming bass was not present.

Table II is presented as further evidence of the fact that our groups not only recognized quality, but appreciated it as well. It shows in what esteem these people held juke box quality, and that the group could distinguish between good and bad quality.

As a further check on the desire for quality listening each group was asked to express itself on the willingness to purchase this high-fidelity equipment. It was explained that the equipment would be expensive since the component parts embodied in its design necessitated expense. Despite this word of caution, 70 percent of those attending expressed a desire to purchase such a system for use in their own homes.

There are, of course, many variables that cannot be controlled in such demonstrations as we conducted. However, it does appear that there is much in these results to suggest that the test group and the public is capable of judging and does appreciate quality reproduction to the extent that in many cases it would spend the money necessary to secure quality listen-

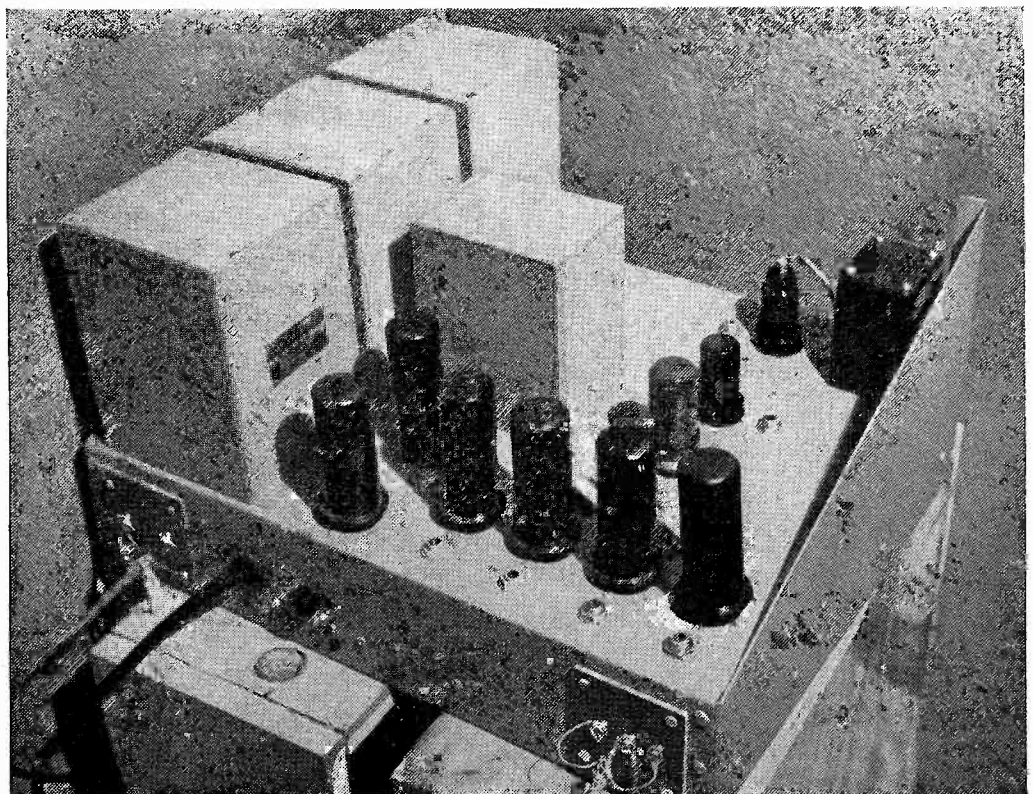

Chassis of 40-watt amplifier

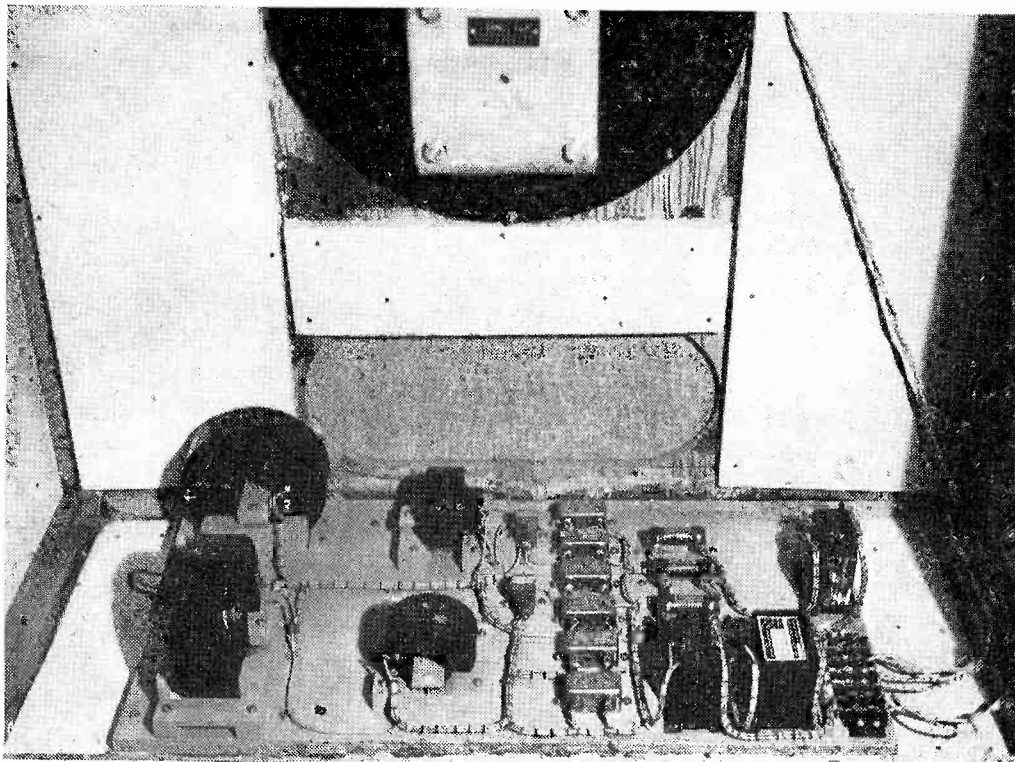

Crossover networks mounted in the bottom of the loudspeaker console

ing. These experiments have also led us to believe that a two-channel system of broadcasting might be well received by the public. It not only has the appeal of the novel, but it does a job that nothing else at present achieves.

Opportunity for F-M

Like most broadcasters, the McClatchy organization is interested in f-m and its implications for the future of broadcasting. It provides an opportunity for the broadcasting art either to benefit by old errors and start anew, or, to adopt an attitude of smug complacency and adhere to the old despite its shortcomings. The answer will in large measure depend upon the set manufacturer, but the broadcaster will also be in a position to exert much influence.

Should either or both adopt the theory that the public can't recognize good quality, then f-m will soon slip into the patterns of performance that characterize a-m today. If f-m broadcasting is to consist of the standard a-m network offering simply rerouted through the local f-m transmitter, then it will be a disappointment to the many who look upon it as the open sesame to quality listening. Under these circumstances the quality will be lost in miles of telephone cable and dozens of telephone repeater amplifiers long before the program reaches the

local f-m transmitter. In fact, f-m will only serve to emphasize some of the distortions that now exist, especially needle scratch, transients, and cross-modulation components. Should the local station depend upon transcriptions, f-m will only serve to make more conspicuous the faults inherent in most modern transcriptions. A possible solution lies in the use of local live talent and highly developed magnetic tape recording. When we first made this suggestion many informed persons threw up their hands at the idea of local talent competing with name attractions.

"Quality or not," they say, "the average listener will not select local talent in preference to known stars."

Frankly, we didn't know what the public would prefer so we decided to get a reaction directly from the public on the matter by letting a representative group listen to local live artists and to transcribed national talent and then express their reactions. There might be many reasons for preferring the name attraction, but only better, more natural quality would determine a preference for the unknown live talent. To this end we secured six new transcriptions featuring world renowned soloists and orchestras. The arrangements were superbly designed to show the artist or band at its best.

The local talent employed was no better and no worse than that existing in any community of 100,000. The local performers were told nothing other than the selection they were to play and were instructed to secure any arrangement compatible with their abilities. The selections to be played were the same as those to be given by transcriptions.

The audio perspective system was set up so that it might be used as a single or double-channel device. Modern broadcast turntables were used and all outputs were monitored to insure the best possible presentation of the transcriptions and the living talent.

The test group was invited by personal and blanket invitation. Although a truly random method of selection was not employed, every effort was made to so distribute the invitations that a fairly representative group would result. The following data show to what extent we succeeded:

Number Present, 175

- (a) 57% female
- (b) 43% male

Age Levels

7-15 yrs—	7%	of total group
16-20 yrs—	8.5%	of total group
21-30 yrs—	15.5%	of total group
31-40 yrs—	25.5%	of total group
41-50 yrs—	36%	of total group
51-60 yrs—	4%	of total group
61-70 yrs—	2%	of total group
71-80 yrs—	1.5%	of total group

Education Level

Grade School only—	8%	of total group
Some High School—	33%	of total group

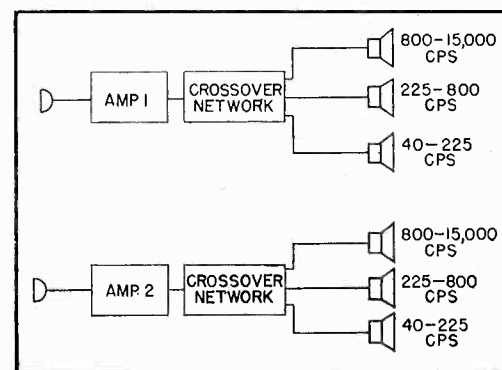

Block diagram of the audio perspective system

Some College—
59% of total group

Vocational Classification

Professional & Scientific—
28% of total group

Housewives—
22% of total group

Clerical & Sales—
18.5% of total group

Students—
13% of total group

Management—
10.5% of total group

Manual Arts & Crafts—
8% of total group

Since random selection was not employed it must be realized that we cannot designate these results as being statistically representative of the general population.

The test group when assembled was told that they were going to listen to six pieces of music and that each piece would be played three times and that each playing

would undoubtedly sound different to the listener. The audience was to participate in the test by ranking each of the three playings purely on the basis of pleasure appeal—which gave the most pleasure, which the next and which the least. The group was not told that it was making a choice between live and transcribed music, nor was any reference made to the source of the output.

The loudspeakers were hidden behind a screen so that the complete senses of the individual listener could be focused on the musical output. Each composition was played three times: transcriptions over single channel, local live talent over single channel, and local live talent over two channels. The three alternatives were so played that any pattern of repetition was avoided. The live music was carried by wire from the originating studio as was the transcribed music. Every precaution possible was taken to insure se-

lection based only on the music itself.

Results

Table III shows the results obtained. The local artists, as was expected, offered nothing that was even remotely equivalent except for the more natural quality of reproduction. It was a situation where a recognition of quality and an appreciation of quality was necessary before the live talent could exert any appeal. The results show, however, that in every case the group found the live music more pleasant than the transcribed music. Table IV, showing the first choice on the

TABLE III—Reproduced Live Music versus Transcribed

Group	Instrument or Orchestral Group Used	Composition Played	First Choice			Second Choice			Third Choice		
			% Selecting Transcription	% Selecting Live Single Channel	% Selecting Live Double Channel	% Selecting Transcription	% Selecting Live Single Channel	% Selecting Live Double Channel	% Selecting Transcription	% Selecting Live Single Channel	% Selecting Live Double Channel
1	Organ Solo	<i>Intermezzo</i> Local organist vs nationally known recording artist	32%	24%	44%	23%	34%	43%	45%	42%	13%
2	Dance Orchestra	<i>I Don't Stand a Ghost of a Chance</i> Local 6-piece orchestra vs a 20-piece nationally known orchestra	15%	36%	49%	21%	43%	36%	64%	21%	15%
3	String Group	<i>When You're Away</i> Local 5-piece string group vs 20-piece nationally known recording orchestra	18%	40%	42%	18%	46%	36%	64%	14%	22%
4	Dance Orchestra	<i>A Kiss in the Dark</i> Group same as 2 above	21%	39%	40%	26%	39%	35%	53%	22%	25%
5	Piano Solo	<i>Polonaise</i> Local pianist vs a world famous piano artist	24%	30%	46%	29%	30%	41%	47%	40%	13%
6	String Group	<i>Artist's Life</i> Group same as 3 above	44%	22%	34%	16%	61%	23%	40%	17%	43%

TABLE IV—First Choices

Group	Live Music	Transcribed Music
1	68%	32%
2	85%	15%
3	82%	18%
4	79%	21%
5	76%	24%
6	56%	44%

basis of live versus transcribed music, brings out this fact even more clearly than Table III.

It is admitted that all persons were not always able to detect and appreciate the subtle superiority of the two-channel offering, yet reference to the third choices, the least-liked choices, in Table III shows that with one exception there was almost unanimous agreement as to the listening superiority of the two-channel reproduction. This is further evidence of the public's ability to enjoy quality when quality is available.

It is not our contention that these tests prove any conclusive point, but we do believe there is enough evidence to justify further study and to dispel any certainty concerning the question. Every technical means necessary for high-fidelity broadcasting and reception now exists. It remains only for the manufacturer and broadcaster to become impressed with the worth of the effort. It is our intention to continue this study further in the hope that our findings will perhaps contribute to the betterment of the broadcasting art as a source of complete listening entertainment.

Photoelectric

By **GEORGE L. BUSH**

*Engineer
The Teleregister Corporation
New York, N. Y.*

THE photoelectric transmitting typewriter to be described was developed as part of a comprehensive system of automatic aids for air traffic control to facilitate the work of radio operators and controllers in sending flight data into their system for display on



Standard typewriter adapted for feeding teleprinter circuits. Light source unit is at right, while phototubes, thyatrons, and associated relays are in housing at left, with pilot lamps and control switches conveniently near the typewriter shift key

CHARACTER ON KEY	CODE ELEMENT							
	1	2	3	6	4	5	7	
ST	1	2	3	6	6	4	5	7
A _K ²	1	2	3	6		4		7
Q	1	2	3				5	7
I	1	2	3	6	6		5	7
U	1	2	3					7
7	1	2	3	6	6			7
/	1	2		6	6	4	5	7
A _J	1	2		6		4		7
W	1	2				5	7	
2	1	2		6	6		5	7
A	1	2		6				7
X	1		3			4	5	7
REP	1		3	6	6	4	5	7
F	1		3	6		4		7
Y	1		3				5	7
6	1		3	6	6		5	7
BELL	1		3	6				7
C _B ^M	1			6		4	5	7
D	1			6		4		7
Z	1						5	7
FP	1			6	6		5	7
E	1							7
3	1			6	6			7
WEA		2	3	6		4	5	7
SUS		2	3	6		4		7
C		2	3				5	7
P		2	3					7
O		2	3	6	6		5	7
I		2	3					7
8		2	3	6	6			7
G		2		6		4	5	7
R		2				4		7
4		2		6	6	4		7
A _L ³		2		6			5	7
•		2		6	6			7
M			3	6		4	5	7
N			3	6		4		7
H			3	6			5	7
SP			3	6	6			7
EM				6	6	4		7
0						4	5	7
9				6	6	4	5	7
T							5	7
5				6	6		5	7
SH				6				7

FIG. 1—Special six-unit code developed for use with photoelectric transmitting typewriter

electric flight progress boards. A standard teleprinter may also be used for this purpose, but many radio operators, because they are expert typists, find it difficult to adjust themselves to the fixed keyboard speed necessary to operate a teleprinter efficiently. The desirability of preserving the touch of the typewriter keyboard led to the choice of photoelectric means for translating the motion of the keys into electric impulses.

Since the device must transmit into teleprinter circuits, the standard teleprinter five-unit code for character identification is used. The total number of code combinations available with this code is $2^5 = 32$. This allows for the 26 letters of the alphabet but not for numbers.

In telegraph practice a shift code is sent over the line which causes the type bracket on the receiving printer to move to upper case, and an upper case character is assigned for every letter of the alphabet. The letters Q, W, E, R, T, Y, U, I, O, P are assigned to the numbers 1, 2, 3, 4, 5, 6, 7, 8, 9, 0. Normal typewriter

operation does not permit inserting a shift character when it is desired to change from letters to figures, and vice versa. To overcome this a sixth element was added to the code, the presence of which causes an upper case character or figure to be transmitted, and the absence of which causes a lower case character or letter to be transmitted. These codes are shown in Fig. 1.

Light Channels

The space directly below the keyboard of the typewriter is divided into seven light channels passing at right angles to the key levers, as shown in Fig. 2A. Six of these channels represent the six elements of the six-unit code. (The function of the seventh light channel will be described later.) To each key lever is attached a shutter, the bottom edge of which is so shaped as to interrupt the light channels according to the code of the character being typed, as shown in Fig. 2B.

The light channels are made as wide as possible ($\frac{3}{8}$ inch each), so that enough light will pass under

Transmitting Typewriter

Teleprinter code messages are sent with a standard typewriter by translating key motions into electrical impulses. Shaped shutters interrupt different combinations of seven light beams for each key, to actuate phototube-thyratron channels feeding a perforator

the shutter to hold the photoelectric circuit until the last 1/16 inch of key lever motion. This assures that the character which is striking the paper is the only one registered, and is necessary because a fast typist may have as many as five key levers in motion at the same time.

The center light channel, for the sixth element of the code, is made wider so that it may be interrupted in sections. Letter-key levers whose upper case characters are not permanently assigned to a number key may have their upper case characters transmitted by use of the shift key. These key levers have shutters which interrupt half of the center light channel. The shift lever has a shutter which interrupts the other half of the center light channel. When only the letter key is operated enough light passes through half the center channel to prevent the photoelectric circuit from operating. When the shift key lever is also operated, the center light channel is completely shut off and the sixth element is introduced into the code, causing the upper case character to be transmitted.

On the teleprinter keyboard the figures 1 to 0 are the upper case characters of the letters Q, W, E, etc. However, on the typewriter these characters have separate keys. In the case of the figure keys the shutter completely interrupts light channel 6, and the lower case letter keys do not interrupt any of light channel 6.

Optical System

The optical system consists of an exciter lamp, a reflector, a condensing lens, and deflecting mirrors. The exciter lamp is a standard

double-filament automobile headlight bulb. The bulb is of the pre-focus type so that it may be replaced without changing the adjustment of the optical system. The mounting of the lamp socket is so arranged that should one filament burn out the other filament may be switched into the circuit and moved into the focal position by operating a lever.

The reflector is spherical and is used to concentrate the source. The single spherical parabolic lens used to condense the light for all seven channels gives a minimum of cross light in the condensed beam. Cross light is further limited by channel separators located at five positions along the path of the beam.

The light channels are so close together that it was not possible to locate the phototubes so that all seven could receive light directly from the light channel. All but the center channel have a mirror to deflect the light from the channel onto the phototube. These mirrors are of the first-surface type so that as little light as possible will be lost in the deflecting operation. All surfaces in the light channel outside the aperture leading to the phototube are finished in dull black to prevent reflections from interfering with the operation. Inside the aperture leading to the phototubes the surfaces are finished white so that as much of the light as possible that enters the aperture will reach the

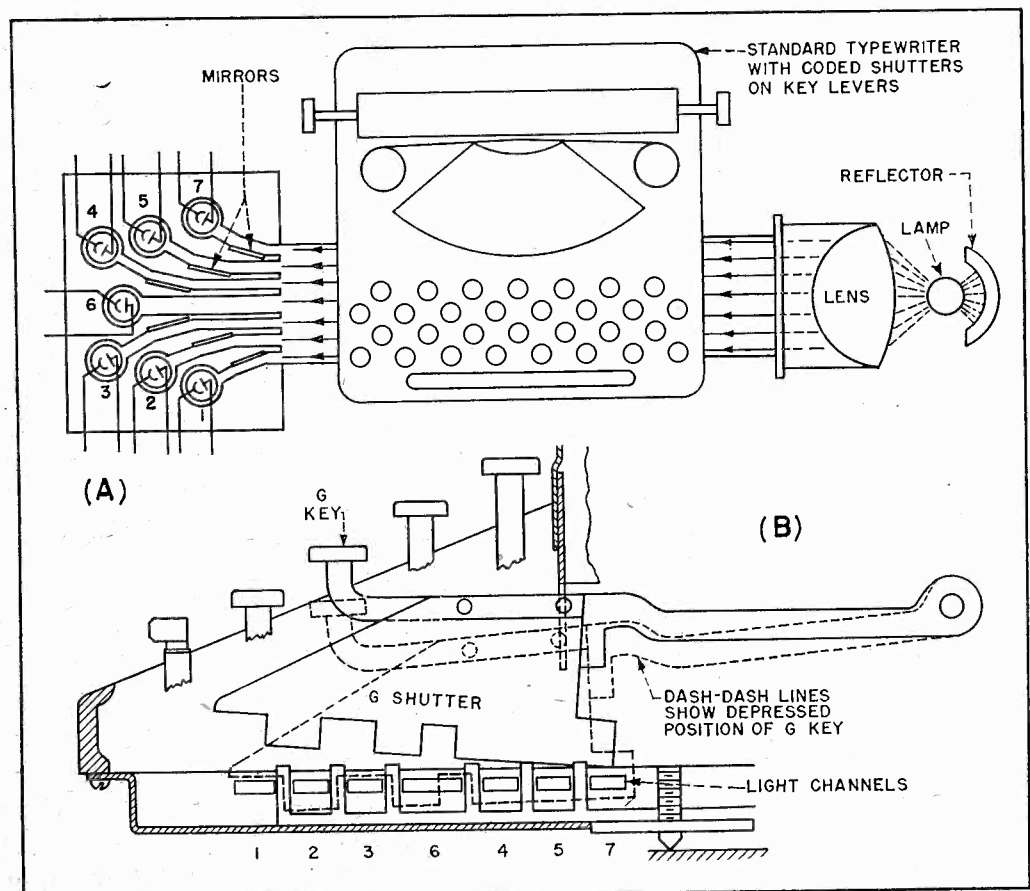

FIG. 2—Details of optical system that directs seven light beams under typewriter keys to phototubes, and side view of shutter for letter G

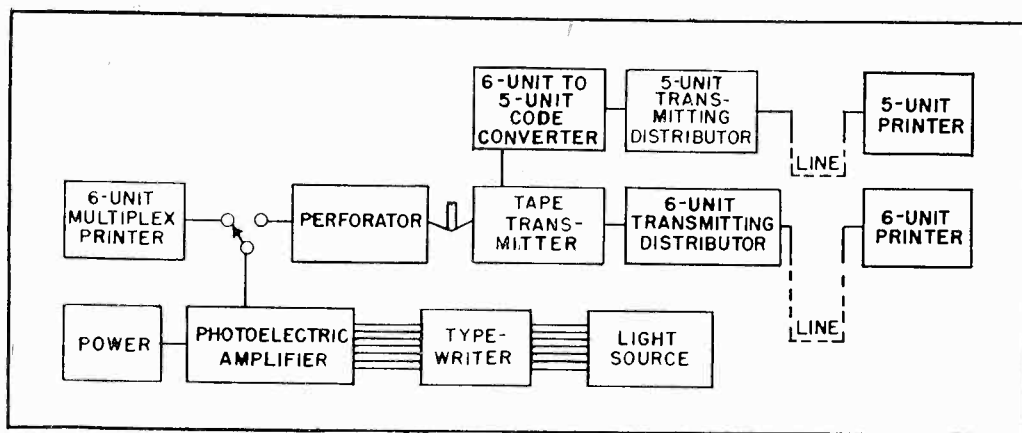

FIG. 3—Block diagram of complete system, illustrating how standard typewriter can be made to actuate three different types of printers

phototube. A new optical system is now under development using the 1P42 miniature phototube and a tubular light source.

Thyratron Circuit

The photoelectric typewriter may work into receiving storage relays of a six-unit code multiplex printer or into a tape perforator and associated equipment, as indicated by the block diagram in Fig. 3.

The photoelectric amplifier circuit for each of the six channels consists of a phototube (929 or 1P42) and a thyratron (2051 or 2D21), all connected as shown for channel 1 in Fig. 4. The bias on the grid of the thyratron is the algebraic sum of the fixed bias determined by the setting of the 3,000-ohm potentiometer and the voltage drop across the 5-megohm grid resistor due to the current through the phototube. The thyratron will fire when this sum is more positive than minus two volts. The fixed bias is adjusted so that the grid potential will remain more negative than minus two volts until all but the last 1/16 inch of light channel is cut off by the shutter, and will become more positive than minus two volts when the light is completely cut off by the shutter. This assures complete registration without interference with other keys.

Plate voltage for the six channel thyratrons is applied through individual trip-latch magnetic coils, a common relay *C*, and a make contact on relay *PR*. The plate current is limited to 200 ma by a 500-ohm resistor in the plate lead to each of the six code-registering tubes. When a key lever is operated,

the tubes for the code combination of the character on the key will fire, and the corresponding trip latches on the perforator will operate, along with common relay *C*. This relay closes the circuit to the perforator punch magnet *PM* through its make contact, punching the code in the tape and, at the end of its stroke, opening a break contact in the circuit to the *PR* relay. The *PR* relay releases and opens the plate circuit to the code-registering thyratrons. The common relay *C* then releases and opens the circuit to perforator punch magnet *PM*. In releasing, punch magnet *PM* resets any trip latches which were operated by the previous code, advances the tape to the next character, and reestablishes the circuit to the *PR* relay.

Universal Seventh Channel

Holding down a typewriter key too long would make the *PR* relay operate and repeat the cycle just described, if an additional photoelectric circuit controlled by the seventh or universal light channel were not provided. The phototube in this circuit is connected to a positive power supply so the effect of light on it is to make the bias on the grid of the thyratron more positive than minus two volts and allow it to fire. The fixed bias as determined by the 3,000-ohm potentiometer is adjusted so the resultant bias on the grid of the thyratron is more negative than minus two volts when the seventh light channel is cut off, thus preventing it from refiring when the circuit to the *PR* relay is reestablished on the release of the punch magnet in the perforator.

Plate voltage for the thyratron in the universal photoelectric circuit is applied through the *PR* relay and the break contact on perforator punch magnet *PM*. The plate current in this circuit is limited to 70 ma by a 1,500-ohm resistor in the plate lead. Every key on the typewriter except the shift key has a shutter which interrupts the seventh light channel. When any key lever is operated, light is cut off from light-channel 7 and the thyratron in the universal photoelectric circuit is prevented from refiring when its plate battery is reconnected by the release of the perforator punch magnet *PM*.

The seventh light channel is located nearest the pivot point of the key levers so that it will be the last to be uncovered when the key is released. All code light channels must have enough light to prevent their photoelectric circuits from operating before there is enough light through the seventh light channel to cause its photoelectric circuit to operate, thus preventing another registration when the key lever is released.

Line Transmission

Provision is made for operating the typewriter normally, without producing teleprinter signals. This was found desirable for some applications, as where preliminary information was typed on the page before the part to be transmitted. The line transmission switch (which may be a foot switch if frequent changeover is required) operates relay *CI* in Fig. 4. In the released position this relay places a fixed bias more negative than minus two volts directly on the grids of the code-registering thyratrons, thus preventing any control by the phototubes. A make contact on the relay cuts a resistance into the primary circuit of the exciter lamp transformer in its released position, to reduce lamp voltage during ordinary typing and thereby prolong the life of the lamp.

Line Feed

The operations of line feed and carriage return are automatically registered on the tape perforator by use of contacts on the carriage

and on the back of the typewriter. For line feed a sensitive snap-action switch is mounted on the left end of the carriage and operated by the jockey roller on the line-feed ratchet wheel. The circuit to the line-feed contact is carried through sliding contacts on the carriage to a receptacle on the back of the typewriter.

The carriage return contacts on the back of the typewriter are actuated by the friction in the sliding contacts in the line-feed circuit. When the carriage is returned the contacts close to complete the carriage return circuit. When the carriage reverses at the end of the carriage-return motion the contacts complete the blank relay circuit, causing a blank character to be punched in the tape.

When a transmitting system operates into a page printer the mechanical motion of returning the carriage requires more time than the transmission time of one character, so the character following carriage return must be a nonprinting function. In normal teleprinter operation this function is line feed. In the normal operation of a typewriter the line-feed motion precedes the motion of returning the car-

riage, so a blank is introduced after carriage return to allow the carriage on the receiving printer to be completely returned before sending the first character of the next line.

The registration of line feed is through relay *LF*, which is in series with a 20- μ f capacitor between +120 volts and ground. The *LF* relay locks through its other winding and trip-latch 2 on the perforator to the same registering circuit as the thyatron. Once the relay is up, the locking circuit assures complete registration. If the pulse from the line-feed contact is long, repeat registration is prevented by the capacitor circuit. Once the relay is operated by the charging current of the capacitor the current is reduced to a low value which will not hold the registering circuit. A 50,000-ohm resistor across the capacitor discharges it when the line feed contact opens, restoring the circuit to normal.

Carriage Return

The registration of carriage return is somewhat different from that of line feed due to two factors. The first is the possibility of receiving the carriage return pulse before line feed is completely reg-

istered, and the second is the necessity of producing a blank registration after carriage return. When the carriage-return contacts on the back of the typewriter close, carriage-return relay *CR* operates on the charging current of the 20- μ f capacitor in the typewriter. If relay *CR* is operated before relay *LF* is released it locks up to a local resistance circuit through a make-before-break combination on relay *LF*. When the registration of line feed is complete and relay *LF* releases, its make-before-break contact combination transfers the locking circuit of relay *CR* from the local resistance circuit to trip-latch 4 on the perforator, which registers carriage return on the tape.

During the time the carriage is returning, the capacitor in the typewriter is being held charged through the operate winding of relay *CR*. When the carriage reverses at the end of the carriage-return motion the charged capacitor is connected to the operate circuit for blank relay *BK*. This relay operates on the discharge current of the capacitor and locks through trip-latch 6 of the perforator, which registers a blank code in the tape.

Run Out

When a tape transmitter is associated with the tape perforator in a transmission system there is a tight-tape switch between the perforator and the transmitter, actuated by the tape, which causes the transmitter to stop when the tape is tight. If the perforator stopped at the end of the message there would be several characters in the tape between the perforator and the transmitter. In order to get these characters into the tape transmitter a run-out key is provided on the typewriter which operates a run-out magnet in the perforator. An adjustable mechanism in the perforator causes enough blanks to be perforated to allow the last character of the message to pass through the tape transmitter.

The system just described may also be adapted to other communication fields, such as interoffice communication in large plants, radio teletype transcribing, and fields where experienced teleprinter operators are not available.

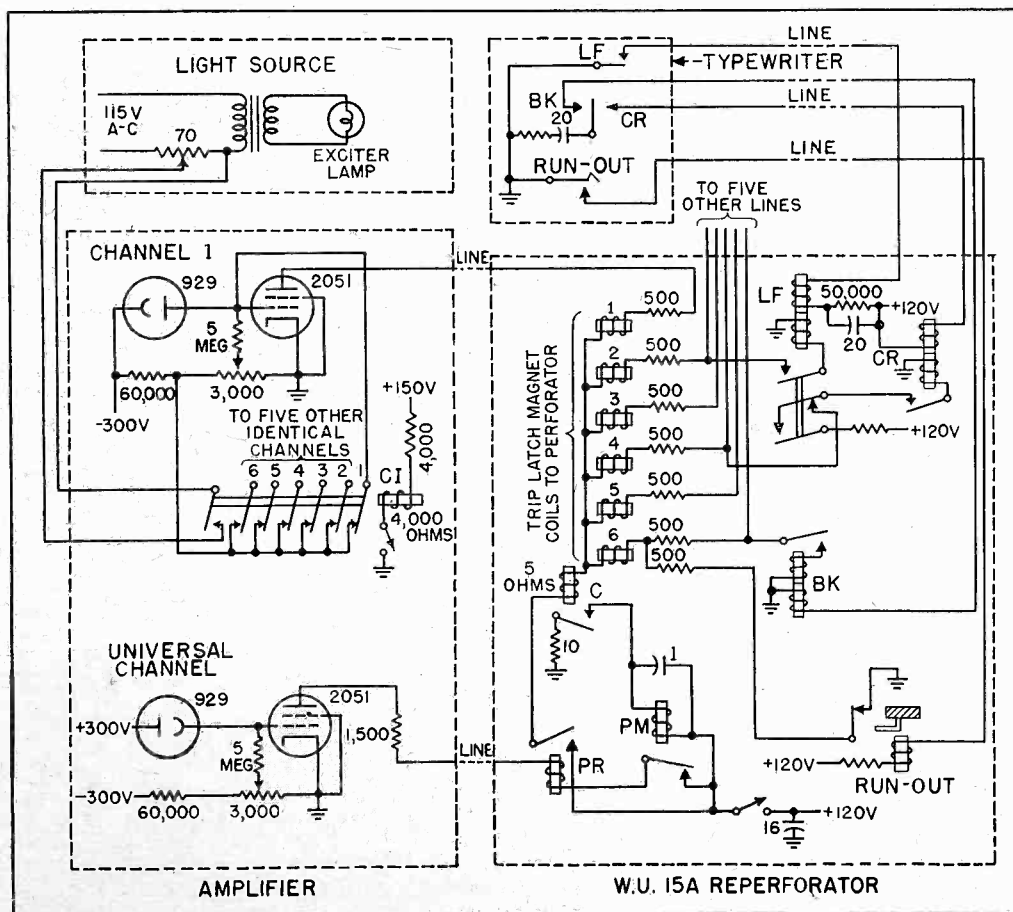

FIG. 4—Circuit of complete photoelectric system and interconnections with Western Union reperfector used to convert to standard teleprinter five-unit code

when the frequency of electrical circuits is increased to a point where inductors and capacitors become too small to handle. A similar transition exists in the field of mechanical vibrations; only, because sound travels so much more slowly than do electromagnetic fields, the transition must be made at much lower frequencies. Velocity of sound in steel and many other solids is of the order of three miles per second, making the length of a longitudinal wave at 455 kc about one-half inch, and a half-wave resonant line is therefore one-quarter inch long, which is not an inconvenient size.

To learn how to arrange mechanical lines to obtain a filter, let us look first at electrical lines which are more familiar. In the left portion of Fig. 1B, a half-wave line is shown which connects a generator to a load; to the right there appears its lumped-circuit equivalent, an inductance and capacitance in series. The following conditions must be met: Resonant frequency left and right should be the same, and characteristic impedance Z_1 of the line should be equal to $2/\pi$ times (about 64 percent) the reactance of L_1 or C_1 at resonance. Then the two networks become equivalent at all frequencies not too far from the resonant frequency F .

Using the equivalence just stated, series inductors and capacitors of the original filter can be replaced by half-wave lines of the proper impedance. There remain the shunt capacitors. These can best be taken care of by means of open-circuited line stubs less than a quarter wave long. For instance, if the stubs are an eighth wavelength long, their reactance becomes numerically equal to their characteristic impedance, which we may call Z_2 .

With these two kinds of line elements, we can now draw the line equivalent of the original filter. Figure 1C shows several half-wave sections of impedance Z_1 , shunted at their junctions by open eighth-wave lines of a much lower impedance Z_2 . Bandwidth ratio W/F , which was previously equal to $2 C_1/C_2$, becomes now $(4/\pi) (Z_2/Z_1)$. With these relations we design a line.

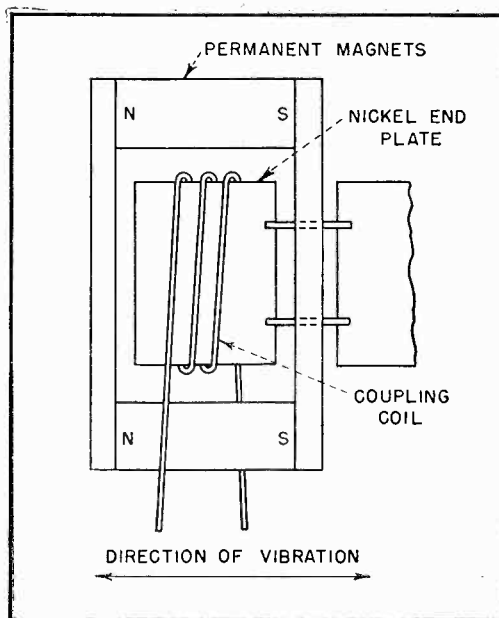

FIG. 2—Magnetostrictive end plates are magnetized and coupled by coils to the electrical circuit

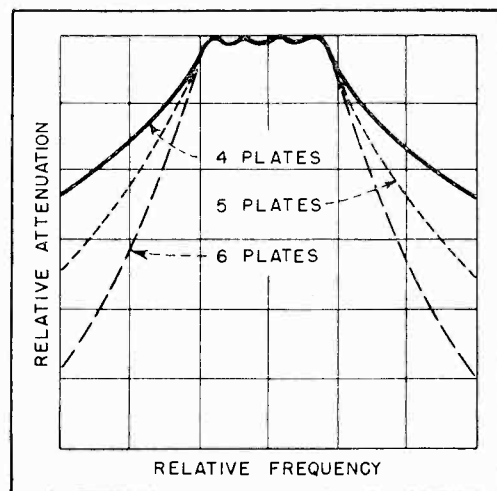

FIG. 3—Cutoff at edges of pass band is sharper for mechanical filters having more plates

To obtain $W = 9$ kc at $F = 455$ kc, Z_2 must be made 1.57 percent of Z_1 . It is apparent that the shunting stubs must be cut from lines of very low impedance; also, the impedances of the terminating half-wave lines should be only $0.5Z_1$.

Equivalent Mechanical Filter

We are now almost ready to apply the knowledge gained with the aid of our electrical model to an equivalent device in which mechanical lines are used. Half-wave and eighth-wave mechanical lines can easily be constructed for a given frequency; all we need to know is the velocity of sound propagation in the medium we select. There remains, however, the need for defining the ratio between the im-

pedances of two mechanical lines, for upon such a ratio depends the bandwidth ratio W/F of the filter.

Let us consider a section of mechanical line made of a given solid material in which vibration is propagated longitudinally. For a fibre of line having one unit of cross-sectional area, isolated from the surrounding body, it takes a certain force to produce a desired motion; then, if total cross-section of the line is A units, the total force required to impart the same motion to the entire area will be A times this certain force. In other words: Force for a given motion is proportional to the cross-sectional area. If we think of mechanical force as equivalent to electrical voltage, it follows that mechanical impedance of the line is proportional to its cross-sectional area.

The rules just derived enable us to design mechanical line elements which, when combined, will produce the desired pass band, but we still need to know how these elements should be interconnected. Let us again refer to the electrical analogy, shown in detail in Fig. 1D. A coupling spring between two mechanical objects exerts equal forces upon both, while taking up the difference between their velocities. Similarly, an electrical shunt connected between a generator and a load maintains equal voltages across both, but takes up the difference between generator current and load current. To act in a manner equivalent to electrical shunts, our mechanical eighth-wave stubs should therefore be connected like coupling springs between the half-wave resonating lines.

Figure 1E shows a highly schematized view of the structure which is obtained by joining mechanical lines together in the manner just derived. Any mechanical structure built in accordance with this schematic design will act as a bandpass filter.

Electromechanical Terminations

The figure calls for a mechanical generator on the left and for a mechanical load on the right, both having the proper resistance but no reactance. Because this filter is

to be used between electrical circuits, generator and load should both be electromechanical converters, somewhat like a speaker and a microphone. For the frequency range near 455 kc, the only suitable converters are piezoelectric or magnetostrictive bars. Such bars always have mass and elasticity, however, and so it seems impossible to construct the desired converters.

To find a way out of this difficulty, let us look once more at the lumped electrical circuit (Fig. 1A) from which our filter was first derived. It is the resistive elements R which cannot be built without introducing reactances. But instead of attempting the impossible, consider the terminating elements R , $0.5 L_1$, and $2 C_1$ as a unit; together they form a tuned circuit with $Q = 0.5[(L_1/C_1)/R]^{1/2}$. This Q , incidentally, is equal to the reciprocal of the bandwidth ratio W/F , becoming 50 for the 9-kc filter.

If it is permissible to consider the resistive elements as damping tuned circuits which terminate this electrical filter at both sides, then, in analogous fashion, the required resistance can be incorporated into the terminating half-wave lines of the mechanical filter by giving them the proper damping.

Finally, the resistances in the

mechanical filter should simultaneously serve as electromechanical converters, which is possible only if the terminating half-wave lines themselves are piezoelectric or magnetostrictive.

Electromechanical Damping

The electromechanical filter must therefore consist of several half-wave resonators with the least possible mechanical damping, coupled to each other and to the terminating elements by eighth-wave lines of much smaller cross section. Electrical properties of all these elements are of no consequence. But the terminating half-wave resonators must be made of piezoelectric or magnetostrictive material. They should have half the impedance of the other resonators, and their damping must be carefully controlled.

A few words about the nature of this damping: If any electromechanical converter—we may, for instance, think of the oldest kind, the rotating d-c generator—is loaded on its electrical side, a reflected mechanical resistance is established which causes expenditure of mechanical energy whenever electrical energy is absorbed from the generator. Mechanical energy consumed by this reflected resistance is not

lost but reappears in electrical form.

Evidently, then, reflected mechanical resistance produced by loading the electrical side of converters provides damping. From an efficiency viewpoint it would be best to produce exactly the required amount of damping in this manner and use no frictional damping at all. In piezoelectric converters this is indeed possible, and with them a filter of the type described could be built having nearly ideal transmission. Magnetostrictive converters, at frequencies near one-half megacycle, are not quite as efficient. Only part of the required mechanical resistance can be produced by electrical loading; the remaining portion is inherent in the mechanical damping—internal and external friction—acting upon the two end pieces. Accordingly, a fraction of the incoming electrical energy is lost in the filter input, and an equivalent fraction of the mechanical energy arriving at the filter output is lost there.

The question may therefore be asked why, in spite of these losses, the magnetostrictive type should have been chosen for a practical design. The answer lies in its simplicity, economy and stability.

A typical filter consists of flat

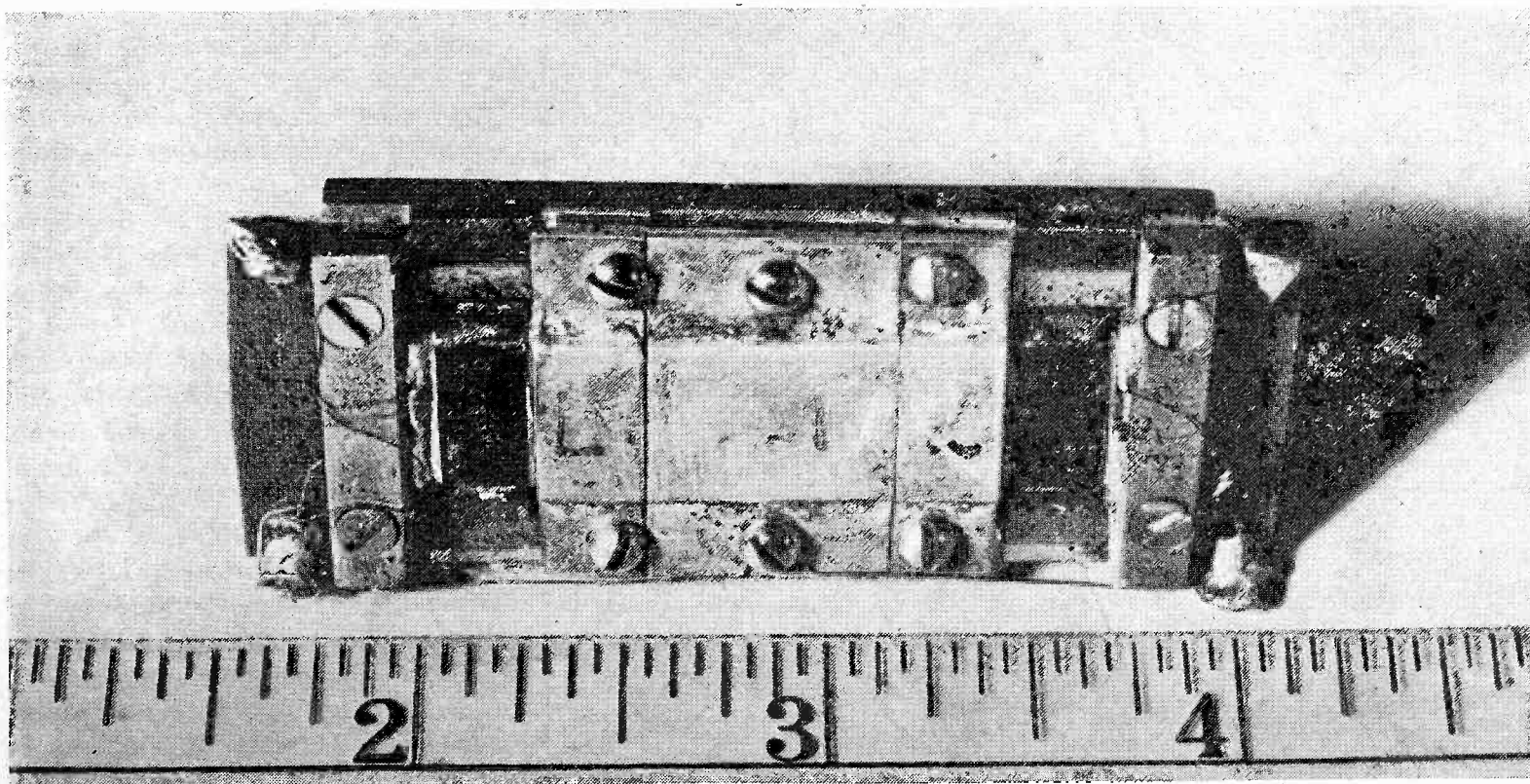

For use in intermediate-frequency amplifier of broadcast receivers, the electromechanical filter is housed in a protective case. Coupling coils are wound around end plates, which are located in the field of permanent magnets

nickel end plates 0.005 inch thick, stainless steel plates twice as thick (to maintain the required impedance ratio) and pairs of parallel steel wires 0.006 inch in diameter, which connect adjacent plates. It is put together by spotwelding the steel wires to the rectangular plates. To put it into operation, each of the nickel end plates is premagnetized in the direction of vibration, by means of small permanent magnets as shown in Fig. 2, and coils are arranged around each nickel end plate to make it vibrate as a magnetostrictive half-wave bar.

The filter structure is held loosely in place between linings of soft cloth or neoprene inside a flat metal cover. As long as no undue pressure is exerted upon the stainless steel plates, their mechanical Q is quite high, between 2,000 and 4,000, and they come fairly close to pure reactances. Consequently, the losses inside the filter, aside from the conversion loss at the terminations

which was discussed before, are very small, and additional stainless steel sections cause no noticeable increase in the attenuation inside the pass band. Every additional section, however, causes sharper cut-off at the band limits. The curves of Fig. 3 show how frequency response varies with the number of sections.

For the six-piece filter shown in the pictures, the combined cross-section of both coupling wires is equal to about 1.5 percent of the cross-section of the stainless steel plates, measured in the direction of vibration. Because they are made of very similar materials, their impedance ratio is also about 1.5 to 100, leading to a theoretical bandwidth of 8.5 kc at 455-kc center frequency. Measured response of this filter is shown in Fig. 4. For purposes of comparison, the i-f response of a conventional receiver of good quality is plotted under the same zero line. It is interesting to

note that the mechanical filter transmits the higher audio frequencies, up to about 4 kc, somewhat better than do conventional i-f transformers; but the adjacent carrier (10 kc away) is attenuated 1,000 times by the mechanical filter. The conventional filter needs 20-kc spacing to do the same.

By using coupling wires with other diameters, pass bands up to 14 kc and down to 4 kc have been obtained in experimental filters. For the wider bands, the low Q required in the nickel end plates becomes more difficult to realize.

Use in Receivers

In a radio receiver, the best place for the electromechanical filter is right after the converter, as shown in Fig. 5. The coupling coils which surround the nickel end plates of the filter structure can most easily be wound for impedances of the order of 100 ohms; transformers are used to match this low impedance to the plate circuit of the converter and to the grid circuit of the following i-f tube.

The insertion loss of the filter in its present form is about 14 db. In designing a practical receiver, however, it has been found that some of this loss can be recovered. The matching transformers around the filter can be built with higher impedances than are normally used in i-f transformers, because the mechanical filter greatly relieves the stability requirements for the electrical circuits, permitting the use of a higher L/C ratio. Furthermore, the insertion loss in the filter reduces the overall i-f regeneration. It seems fair to say that, in a balanced i-f design, the net loss caused by introducing the filter in its present form is between 6 and 10 db, corresponding to a reduction in gain by a factor of two or three for a given tube combination.

Temperature variations affect the mechanical resonant frequency of the half-wave plates, causing the pass band as a whole to shift by a small amount. If the plates were made of plain steel, a temperature rise of 50 degrees F would shift the band by somewhat more than one kilocycle. Stainless steels are available which show much smaller frequency shift; plates are prefer-

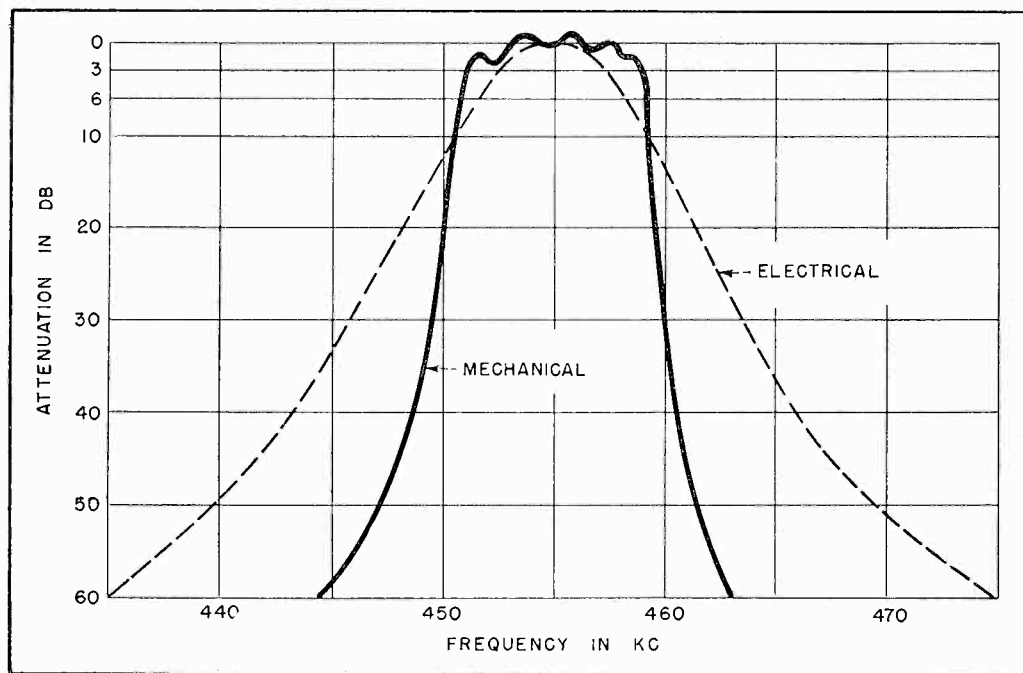

FIG. 4—Comparison of electrical and electromechanical filter bandpass characteristics

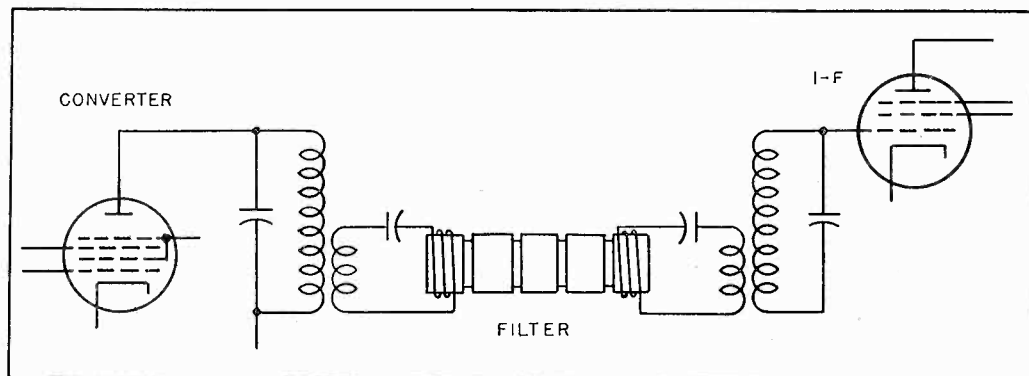
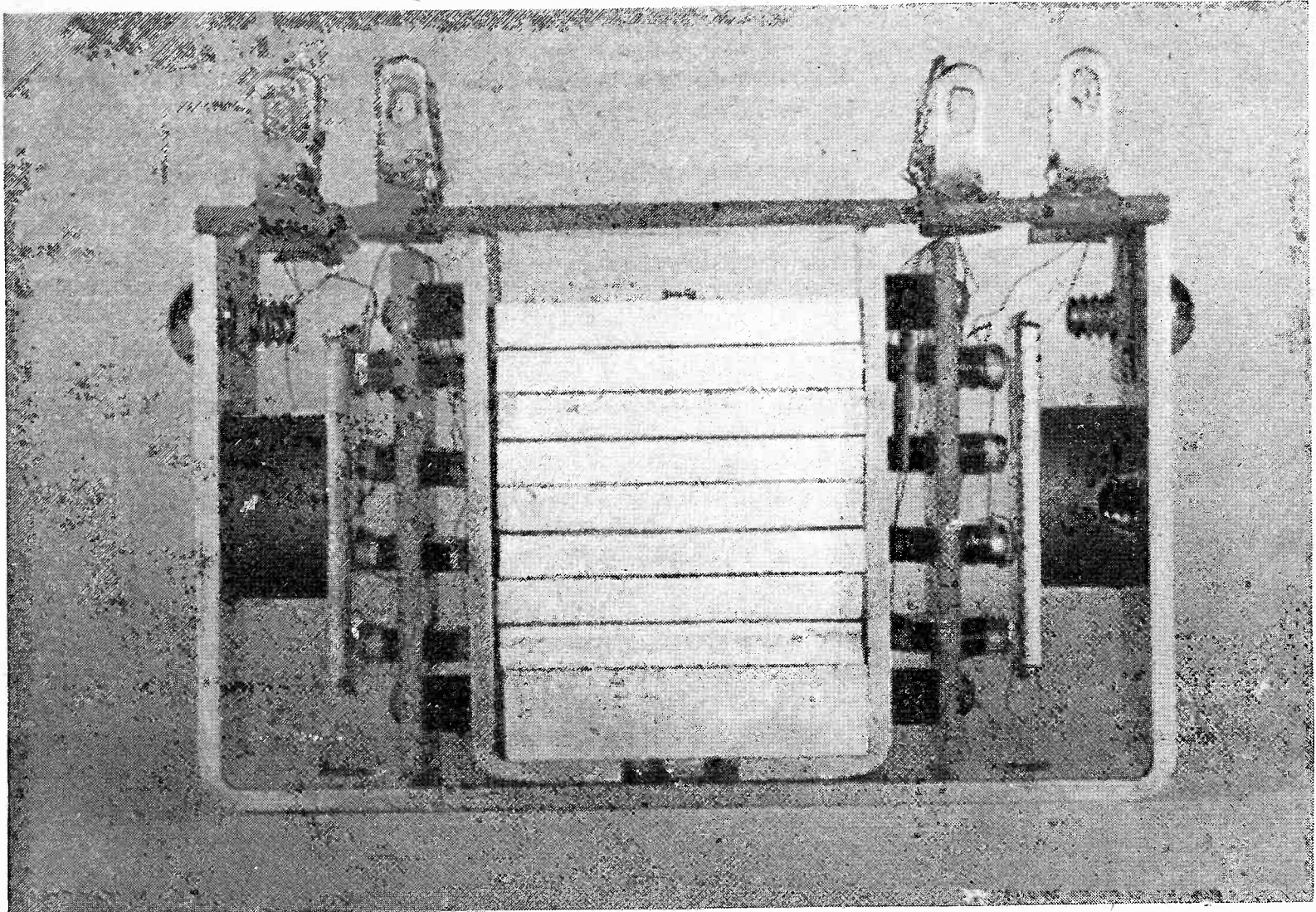

FIG. 5—Electromechanical filter is most effective if used between converter and first i-f amplifier



In experimental receiver, four filters with different bandwidths are assembled in a single structure. Any filter can be selected by four-position switch (switching is simple at the 100-ohm impedance of the filter terminations). Merits of different bandwidths can thus be determined

ably made from such materials.

Receiver Performance

The performance of a broadcast receiver equipped with the six-piece filter described (two times down 4.5 kc off center, 1,000 times down 10 kc off center) is interesting in many respects. It was first suspected that such a set would be hard to tune, but tests with a number of lay listeners did not bear this out. Change in tone quality caused by incorrect tuning sets in at two clearly defined points much more abruptly than in conventional receivers; listeners seem to find it quite easy to tune between these two points.

With correct tuning, tone quality appears to be quite similar to that of conventional sets. One might expect to hear unfamiliar transients around 4,000 cps caused by the unusually sharp cutoff of the pass band, but nothing unusual could be detected. It appears that at 4,000 cps, where the sensitivity and

discrimination of the human ear are not as good as in the medium range, an even greater rate of cutoff would be required to produce noticeable transients.

Adjacent-channel selectivity, of course, is the distinctive feature of a receiver using the electromechanical filter. Any desired channel can be tuned in even if there is a strong local signal on an adjacent channel. In Chicago, for instance, it is possible to tune in the New York transmitters WNBC, WOR, WJZ, and WCBS, although there are Chicago stations (three of 50,000 watts and one of 10,000 watts) separated only 10 kc from each of these four New York channels. It would take rather expensive electrical filters to equal this performance.

While economical adjacent-channel selectivity may be a highly desirable feature in broadcast receivers, especially for certain regions, it is of paramount importance for communication receivers. The new filter, together with its coils and

magnets, weighs less than an ounce and takes less than one cubic inch of space. Its essential parts are stainless steel, easily manufactured by punching and spotwelding. There are no adjustments which could drift or vary; the frequency response is fixed.

Much further development remains to be done; improvements in the electromechanical conversion efficiency of the nickel end plates would be very useful; and careful study of alloys, dimensions and coupling coil design may well bring such improvements about. Economical production methods must be developed. The present structure seems simple enough, but it has not yet been manufactured in quantity.

It should not be forgotten that this structure represents only one among many possible forms. Other varieties, perhaps based on other modes of vibration, might be found which are simpler, and perhaps can be punched out in a single operation.

mately 90 degrees, the conditions for rotation of a two-phase motor are satisfied.

Dynamometer Action

The motor is mechanically coupled to the iron armature of the receiver coil in such a manner that rotation of the motor caused by unbalance of the bridge drives the armature in the direction necessary to rebalance the bridge. A suitable device for indicating or recording displacement of the receiving armature may also be driven by the motor and armature linkage.

Reactive currents in the bridge circuit, comprising components 90 degrees out of phase with the line voltage, will be either in phase with or 180 degrees displaced from the reference line phase and will therefore produce no rotation of the two-phase motor. Thus the servo unit acts as a true power detection device or dynamometer.

There is a widespread misconception regarding impedance bridges. Many engineers believe that a current detector is the only necessary detecting element across the center leg of the bridge. A true impedance balance can only be found, however, by using a detector which is responsive only to the real component of unbalance current. Therefore a detector of the dynamometer (wattmeter) type, which measures only in-phase current, is necessary to indicate true balance.

The motor generally supplied with the variable-area type of re-

mote flow rate indicator is of the two-phase, low-inertia, high-torque type. Various types of motor drive circuits may be used, the choice depends largely on the power output required. Among the types developed are the direct drive, the transformer coupled, the thyatron drive and the saturable reactor type of motor drive circuit. However, with the saturable reactor type of drive circuit it was difficult to achieve the high instantaneous braking forces obtained with other systems. These braking forces are an important consideration, since damping is the greatest problem in all servomechanism applications.

One of the prime considerations in the damping problem lies in the choice of the rebalance motor. It should obviously have the lowest inertia rotor assembly with the highest torque possible. In some applications it is advantageous to supply the motor drive tubes with unfiltered direct current from a full-wave rectifier supply. The resulting 120-cycle pulsations, transmitted to the motor by a transformer, provide excellent dynamic braking.

These pulsations literally have the motor running at full speed when the system is in balance. In a 60-cycle system the motor will develop full torque in one direction for 1/120th second while during the next 1/120th second it develops full torque in the opposite direction. This motion is very slight and is not perceptible at all when reduced

through a gear train. The chattering rotor, however, helps to overcome the effect of friction in the system. Since the unit already is in motion, very small signals will be responded to and will initiate rebalance of the bridge.

Armature Design

The reduced size of the transmitter armature has an important effect on flow measurement. Normally the larger floats may be displaced from their rest positions by the electromagnetic force or solenoid action of the transmitter and receiver coils. This has required special precautions during calibration.

The float must be in an instrument that is energized during calibration to correct for the effect of any electromagnetic forces. The weight of the armature has been reduced to a fraction of a gram.

In conjunction with the very low magnetic forces of the small coils, electromechanical displacement of the float becomes too small to be measured. With the float in a flow stream of five cubic centimeters of water per minute, no deviation of float position with the coils either energized or disconnected is noted.

Reduced eddy current losses in the armature prevent vaporizing volatile fluids by excessive heating effects.

Another advantage of this small primary element is that noble metals can be used for the purpose of corrosion resistance.

The trend toward float and armature assemblies of miniature size was initiated by the need for accurate measurement of the small flow rates encountered in laboratory scale operations, as well as for the small industrial flow rates associated with the manufacture of perfume essences, vitamin additives, synthetic rubber modifiers and numerous other processes requiring a high degree of control over small liquid and gas flows.

BIBLIOGRAPHY

- (1) Harrison, T. R., Wills, W. P., and Side, F. W., A Self Balancing Potentiometer, *Electronic Industries*, p 68, May 1943.
- (2) Dickey, P. S., Hornbeck, H. A., Electronic Type Instruments for Industrial Processes, *Trans. of A.S.M.E.*, p 393, July 1945.
- (3) Hunter, Paul H., Phase Sensitive Bridge Detector, *Electronic Industries*, p 60, June 1946.

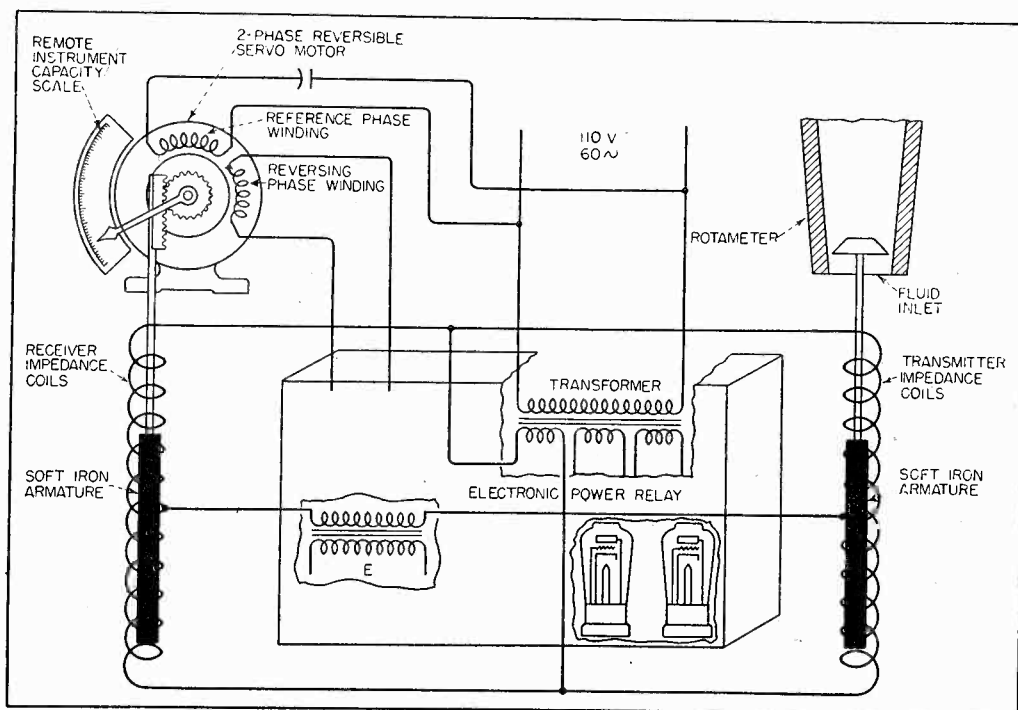

Complete setup of the elements in the electronic null balance

Helical Beam Antenna

Three uniform helical beam antennas for 10-cm operation. The one at the top is shown with its ground-plane plate in place

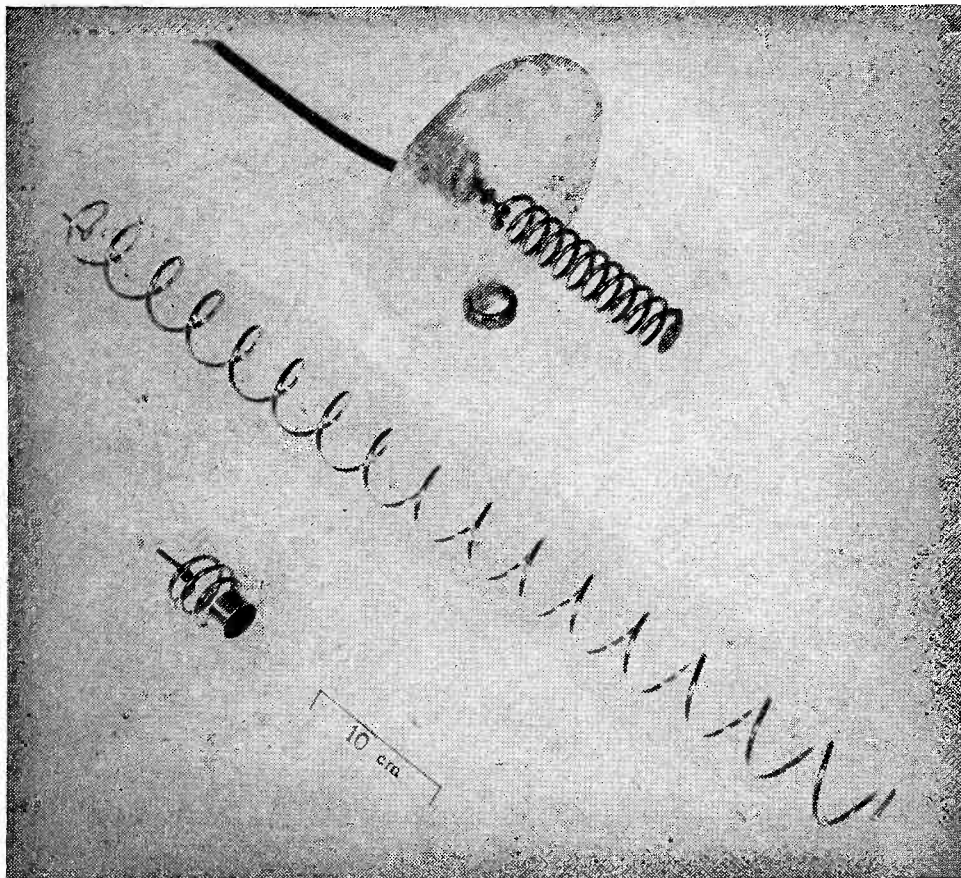

By JOHN D. KRAUS

Department of Electrical Engineering
Ohio State University
Columbus, Ohio

Axial mode radiation provides circular polarization, with readily controlled directivity and gain. Dimensions for 10-cm operation are given

A HELIX with a circumference of one wavelength can be excited as a beam antenna. Radiation is maximum in the direction of the helix axis, and is circularly polarized.

This new mode of operation of a helix is known as the axial or beam mode. The polarization is right or left-handed, depending on the direction in which the helix is wound. The helix may be uniform or tapered. The former type is called a uniform helical, and the latter a tapered helical beam antenna.

The photograph on this page illustrates three examples of uniform helical beam antennas. All are designed for 10-cm operation. The medium-length helix (1.2 wave-

lengths long) has a beam width between half-power points of 43 degrees. The longest helix (6 wavelengths) has a beam width of 20 degrees. The shortest ($\frac{1}{2}$ wavelength) has a beam-width of 58 degrees. Ground planes are used with all three antennas.

Referring to Fig. 1 (left), a helix is shown mounted on a ground plane and excited by a coaxial transmission line. The axial or beam mode produces the maximum radiation in the direction of the axis of the helix, a typical radiation pattern being as indicated.

At this point it may be well to distinguish clearly between this axial mode and another mode of operation of a helical antenna.¹ The

other mode produces circularly polarized radiation having an omnidirectional pattern, with maximum radiation perpendicular to the axis and a null in the direction of the axis as shown in Fig. 1 (right). The helix dimensions required to produce the omnidirectional mode are different from those required to obtain beam mode discussed herein.

The beam mode should also be distinguished from the mode of helix operation used in the traveling wave tube². In the traveling wave tube the helix circumference is only a small fraction of a wave-

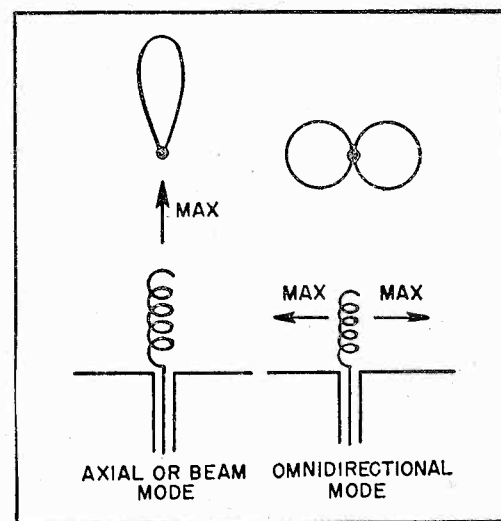

FIG. 1—Axial or beam mode of helical antenna discussed (at left), and omnidirectional or perpendicular mode requiring other dimensions, with which the new mode should not be confused (at right)

length and no antenna beam mode is present.

Nature of Beam Mode

To understand the nature of the beam mode, consider a traveling wave on a helix one turn of which equals a wavelength. At a given instant regions of positive and negative electric charge appear at opposite ends of a diameter, as indicated in Fig. 2A, which shows the helix viewed from a point on the axis. The instantaneous direction of the electric field lines is then as shown. With passage of time the regions of charge travel along the helix and the field rotates, making one revolution per cycle. Thus an observer located on the axis on the helix (perpendicular to the page) receives circular polarization.

Referring next to Fig. 2B, the dimensions of a conductor wound in the form of a helix will be designated as follows: S , the spacing between turns; D , the diameter of the helix; and L , the length of one turn. Dimensions S and D are center-to-center distances. Assuming a traveling wave on the helix, it may be shown that a condition for circularity of polarization in the direction of the axis is fulfilled when

$$L - S = n\lambda \quad (1)$$

where λ is the wavelength and n is any odd integer.

A condition for maximum directivity along the axis is also expressed by Eq. 1. When $n = 1$ both conditions are fulfilled. This case is the one considered here.

The relation between the diameter, turn length, and turn spacing of a helix is given by

$$D = \sqrt{L^2 - S^2}/\pi \quad (2)$$

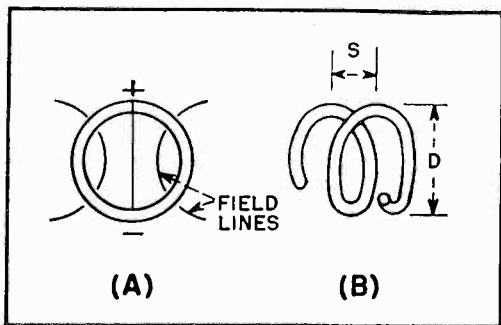

FIG. 2—Electric field (A) around a single turn of a helix which is one wavelength in circumference, and (B) dimensional rotation referred to in the text

Substituting for L from Eq. 1 in Eq. 2 we can express the relation of Eq. 1 in terms of D and S . Figure 3 is a graph of this relation for $n = 1$.

Numerous uniform helical antennas with spacing S between 0.1 and 0.4 wavelength have been constructed and found to generate the beam mode. The diameter D for a given spacing to produce the most nearly circular polarization was usually between the curve value in Fig. 3 and a value about 25 percent less.

Axial Ratio of Polarization

The ratio of the major to the minor axis of the polarization ellipse of the electric field intensity is called the axial ratio. The axial

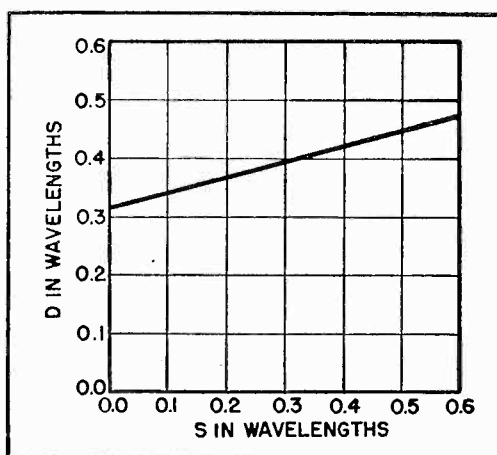

FIG. 3—Relation between diameter D and spacing S for the beam mode of operation

ratio is unity for circular polarization and infinite for a plane polarized wave.

Axial ratios of 1.2 or less are readily obtainable with helical beam antennas. Experimentally it is found that the axial ratio can often be reduced by bending the last turn of the helix (open end) to change the spacing of the last turn. An alternative method is to attach a disc or ring to the end of the helix. The position of the disc or ring along the axis is adjusted for minimum axial ratio.

Beam Width and Gain

With a helix of given diameter and turn spacing, the beam width is a function of the overall length of the helix, the beam becoming narrower with increased length. The measured beam widths of the

three antennas pictured have already been indicated. Based on the directivity patterns, the short, medium, and long helices have directed power gains over an isotropic circularly polarized source of 11, 13, and 20 db respectively.

The measured electric field intensity patterns in the plane of the axis are presented in Fig. 4. for the medium length helix. One curve shows the vertically and the other the horizontally polarized component of the radiation. The antenna is a uniform helix with $S = 0.12$ wavelength and $D = 0.28$ wavelength. The conductor diameter is 0.035 wavelength. The measured axial ratio is 1.1 in the direction of the axis.

The dimensions of the short helix are 0.5 wavelength long, $S = 0.11$ and $D = 0.33$ wavelength; and for the long helix $S = 0.38$ and $D = 0.38$ wavelength.

The pattern measurements given above were made with the antennas mounted on a square ground plane 5 wavelengths on a side.

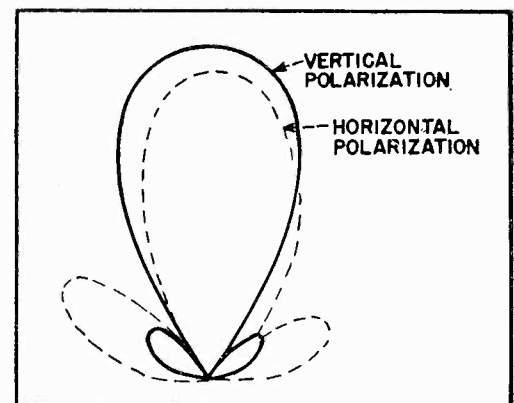

FIG. 4—Field intensity patterns of uniform helical beam antenna 1.2 wavelengths long

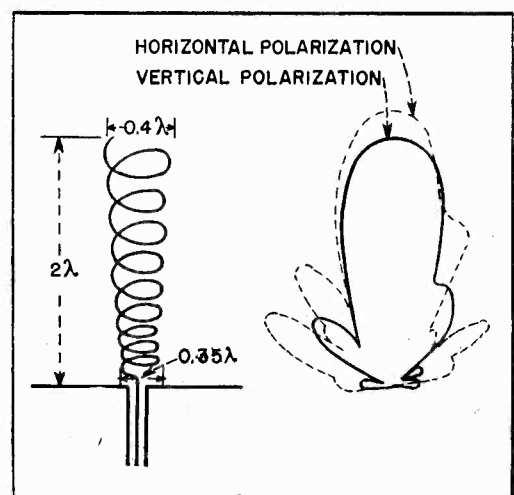
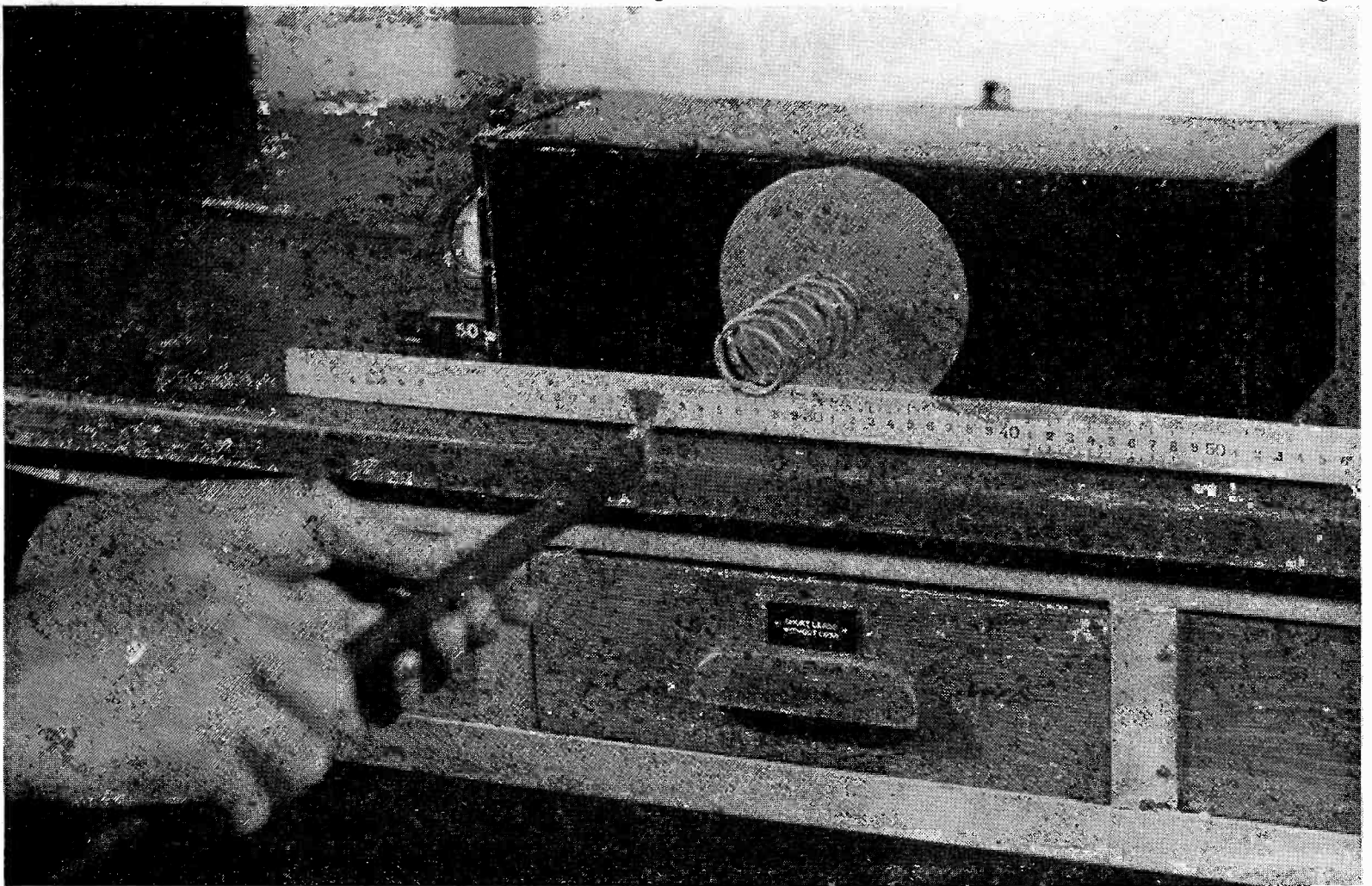

FIG. 5—Tapered helical beam antenna, with field intensity patterns



Circularity of helical beam transmitting antenna polarization may be observed by rotating a linearly polarized receiving antenna at the end of a probe, response being constant with rotation

The helical antennas so far described are of the uniform type. By increasing the spacing, S , as a function of the distance along the axis of the helix and simultaneously increasing the diameter, D , in accordance with the curve of Fig. 3, a tapered helix can be constructed having circular polarization and maximum directivity along the axis.

A 9-turn tapered helical beam antenna 2 wavelengths long with a diameter of 0.35 wavelength at the feed end and 0.4 wavelength at the open end is illustrated in Fig. 5, with the measured field intensity pattern. The beam is 33 degrees between half-power points (16-db directed gain) and the axial ratio is 1.17.

Terminal Impedance Characteristics

The terminal impedance of a helical beam antenna is a function of frequency, and also depends upon the dimensions of the helix including the conductor diameter, and the spacing of the helix from the ground plane. Spacings of 0.1 to 0.2

wavelength have been employed.

The impedance values of a typical helical beam antenna at frequencies near the one giving optimum circularity and directivity are in the range of 100 to 500 ohms resistive, and $\pm j300$ ohms reactive (when off resonance). Hence for maximum power transfer from a 100-ohm line, for example, a transformer section between the 100-ohm line and the antenna may be required.

Helical beam antennas can be scaled to operate at any wavelength. The dimensions have been given in wavelengths to facilitate scaling. They can be employed for both transmitting and receiving. Reception of waves radiated by a helical beam antenna may be accomplished by either a linearly polarized antenna placed vertically, horizontally, or any angle between, or by a circularly polarized antenna having the same direction of rotation of the electric vector. Thus if a helical beam antenna is employed for reception it should be wound in the same direction as the transmitting

helix, that is, both should be wound right-handed or left-handed.

When used on a ground plane, beams of wide or narrow width may be obtained, depending on the helix dimensions. To obtain sharper beams a helical antenna can be used as the primary source to illuminate a parabolic reflector. Another application is the generation of a circularly polarized TE_{11} mode in a circular waveguide.

Acknowledgment

The author is indebted to Dr. George Sinclair and Robert B. Jacques of the Antenna Laboratory of the Ohio State University Research Foundation for their kind cooperation, and to R. A. Fouty and W. P. Summers for assistance in measuring some of the characteristics of the antennas described.

REFERENCES

- (1) Wheeler, H. A., Helical Antenna for Circular Polarization, presented orally at March 1947 IRE convention, New York.
- (2) Wideband Microwave Amplifier Tube, *ELECTRONICS*, p 90, November 1946.

METALLIZED

FIG. 1—Counting circuit for determining the number of times the dielectric of a metallized capacitor arcs through

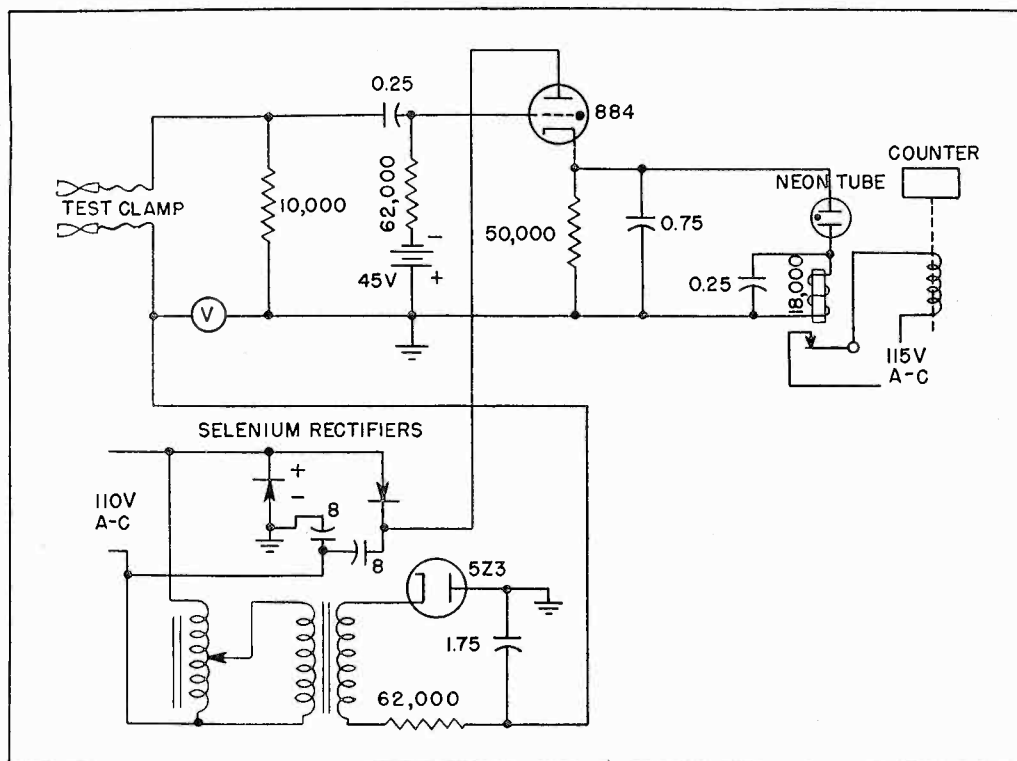

DEVELOPMENT of the high-speed diffusion pump for industrial as well as laboratory use has created many new commercial processes involving the use of high vacuum. Among them is the process of thermal evaporation of metals and their salts, which can be accomplished satisfactorily only in absolute pressures in the micron range.

Since all metals have a definite vapor pressure at any given temperature, all that is required to evaporate a metal is to reduce the pressure of the surrounding atmosphere below the vapor pressure of the metal being heated. Normally, pressures of from 10^{-4} to 10^{-1} mm Hg are maintained in vessels used for evaporation. Table I gives the approximate evaporation temperature of various metals at 10^{-2} mm Hg.

Table I

Metal	Evaporation Temperature at 10^{-2} mm Hg
Aluminum	1000C
Copper	1270C
Silver	1050C
Tin	1350C
Zinc	340C

The evaporation vessel is evacuated to the desired pressure by a combination of mechanical vacuum pumps and diffusion pumps. The metal to be evaporated is then heated in any convenient manner to its evaporation temperature, and the material to be coated is maintained relatively cool so that the metal vapor condenses upon contact

with it. Naturally, practical evaporation processes are not nearly so simple as set forth in the foregoing, but this serves to describe the basic principle.

As early as 1932 the Robert Bosch Co. started experimental work in Germany on a process to evaporate thin zinc films onto capacitor paper. From 1936 until the end of the war they are reported to have made as many as 40 million metallized paper capacitors¹ and apparently made many improvements in their evaporation process during this period.

In 1943 the British started producing capacitors made from aluminum-coated paper. Apparently, this activity was stimulated by the discovery of metallized paper capacitors in German aircraft shot down over Britain early in the war. Capacitors of this type are being produced in this country.

The subject of self-healing of thin metallic-coated capacitor papers, and of capacitors made from them, is difficult to define in exact terms². However, it is claimed that metal coatings whose thickness is of the order of one micron will evaporate or oxidize around an area where there is a conducting

particle or a hole in the dielectric when a current passes through the particle or hole. The evaporation or oxidation of the metal film around this area breaks the conducting path, and the paper or capacitor is healed, since no further current can pass through the dielectric to the film unless the voltage gradient is increased.

Test Circuit

To prove and demonstrate the self-healing property of metallized dielectrics and to determine the factors which enter into this phenomenon, a series of tests have been made. A counting circuit³ was used which, through a relay, would operate a magnetic counter as illustrated in Fig. 1. By means of this set-up, the number of discharges through the metallized capacitor paper were recorded up to a maximum of ten per second, which was the limit of the counter used.

A voltage was established across the metallized paper by means of the clamp illustrated in Fig. 2. This was increased in 10 to 25-volt steps at one-minute intervals, and the number of discharges during each interval was noted until a

CAPACITOR TESTS

Discharges through paper of metallized capacitors are counted automatically as voltage is raised in small steps. Results of tests, dielectric constant measurements, and percent increase of power factor due to resistance of the metal coating are given

By **PHILIP GODLEY** and **JAYSON G. BALSBAUGH**

*National Research Corp.
Boston, Massachusetts*

*Massachusetts Institute of Technology
Cambridge, Massachusetts*

maximum of 350-400 volts was achieved. The voltage was then dropped to zero, and the foregoing procedure was repeated two or more times.

Since it was felt that the two principal contributing factors to the phenomenon of self-healing were the thickness of the metal film and the energy available in the circuit feeding the test sample, coatings of various thicknesses were tested using various resistances in series with the test sample. Obviously, self-healing would not occur if the metal coating were thick enough to conduct the heat caused by the discharge away from the point of discharge rapidly enough to prevent evaporation or oxidation of the coating. Likewise, if the energy supplied to the discharge were too great, there would be danger of carbonizing the paper, thereby causing a complete breakdown. Also it was felt that there should be some relationship between these two factors.

Results

Some typical results of the tests made are given by the curves illustrated in Fig. 3 and 4. The paper used in all tests was 0.0004 Kraft capacitor tissue, and no attempt was made to dry it out. Probably a large percentage of the discharges noted was due to moisture present in the paper, and the results obtained should not be construed as indications of the quality of the paper. The metal used for coating the paper was zinc, and the thicknesses of the coatings were selected

to give d-c resistances of approximately 10, 20, and 30 ohms per foot on a strip one-inch wide. Two pieces of the metallized paper, approximately two inches square, were inserted between the plates or jaws of the clamp, and the metal film on the lower sheet connected to the lower jaw of the clamp by inserting a U-shaped strip of aluminum foil. Resistances of 2,500; 10,000; 50,000; 150,000; 1,000,000; and 3,200,000 ohms were placed in series with the test capacitor.

The results of the tests prove that thin metal films coated on capacitor paper will self-heal. In only one case, using the test procedure described, were there any discharges below 250 volts after the procedure had been repeated three times, and only once was there a

short circuit through the paper which did not heal. If the voltage were rapidly increased to a high value of about 250 volts, a series of discharges would occur in such rapid succession as to be almost continuous, and there would be danger of a complete short circuit. However, once the metallized paper had self-healed up to 250 volts, there would be no further discharges no matter how rapidly the voltage was increased up to this value.

Coatings whose resistance measured about 30 ohms per foot on a one-inch strip seemed to heal more readily than heavier coatings. But even the thickest coating (10 ohms) appeared to be perfectly satisfactory in this respect. For most satisfactory results in self-healing, a

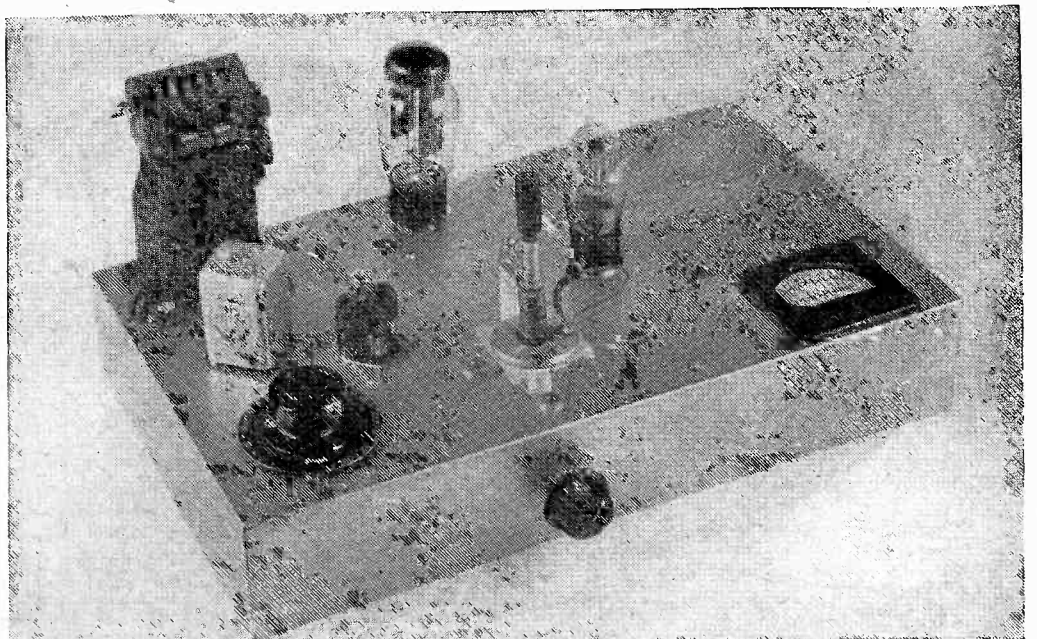

FIG. 2—Electronic test unit used in the self-healing experiments. Square sections of metallized paper were inserted between the plates of the clamp

series resistance of the order of one megohm would seem advisable. This value should be adjusted to conform to the circuit feeding the test sample.

Dielectric Constants

Numerous tests have been made to determine the dielectric constants of metal-coated paper as compared to the same paper uncoated.

The relative dielectric constants of the untreated paper as compared to the metallized paper are given in Table II. It will be noted that values are given for different numbers of paper sheets measured as a group. These dielectric constants have been measured at a frequency of one kilocycle with a two-inch diameter ground surface electrode under a pressure of approximately 10 pounds per square inch.

Accurate dielectric constant measurements on thin samples of a dielectric are normally very difficult to make. This is especially true of paper in view of its construction. For thin, continuous dielectric films, such measurements are made by use of sprayed metallic surfaces or by the use of Aquadag surfaces or silvered surfaces. These are not applicable to paper in view of its fibrous construction.

The difficulty in making such

measurements may best be appreciated by an example: Assuming a one-mil dielectric film with an actual dielectric constant of five, the measurement of such a film with a 0.1-mil air space between the film and the metal electrode will give a measured dielectric constant of 2.5 instead of the actual value of five.

The dielectric constant values given in Table II show that the dielectric constant values for the metallized paper are very much greater than for the plain paper. These increases are probably in most part due to better electrode contact with the paper and also a decrease in the effective paper thickness. Since metal coatings follow the contour of the surfaces on which they are deposited, there is probably a larger plate area than would be true in the case of foil.

Order of Layers

The measured dielectric constant values of the metallized paper depend upon the arrangement of the coated side of the samples in the paper stack that is being measured. In one case the arrangement is as follows: electrode, zinc coating, paper, paper, zinc coating, zinc coating, paper, paper, zinc coating—and continuing in this manner depending upon the number of paper

sheets to the other electrode. In the other case the arrangement is electrode, zinc coating, paper, zinc coating, paper, and so forth, to the other electrode.

In the first case, the metal coatings are adjacent to the electrodes, and the paper surfaces are adjoining. In the second case, the paper surface is in contact with a metal-coated surface, and the other electrode is adjacent to a paper surface.

It is probably true that higher electrode pressure would give increased dielectric constant measurements. However, what is desired is the relative dielectric constant when used in an impregnated paper capacitor. This may differ from the values given in Table II both because of the use of a liquid impregnant instead of the air and also because of different effectiveness of contact. However, the foregoing results indicate that metallized paper should give increasing capacitances per unit volume of the dielectric for the same effective gradients.

Table II shows measurements that were made at room temperature of approximately 25 C, a frequency of one kilocycle, and applied voltage of approximately 25 volts. The electrodes were two-in. diameter, ground surface, stainless steel under pressure of ten pounds per

Consecutive exposures to a rising voltage plotted against the number of arcs

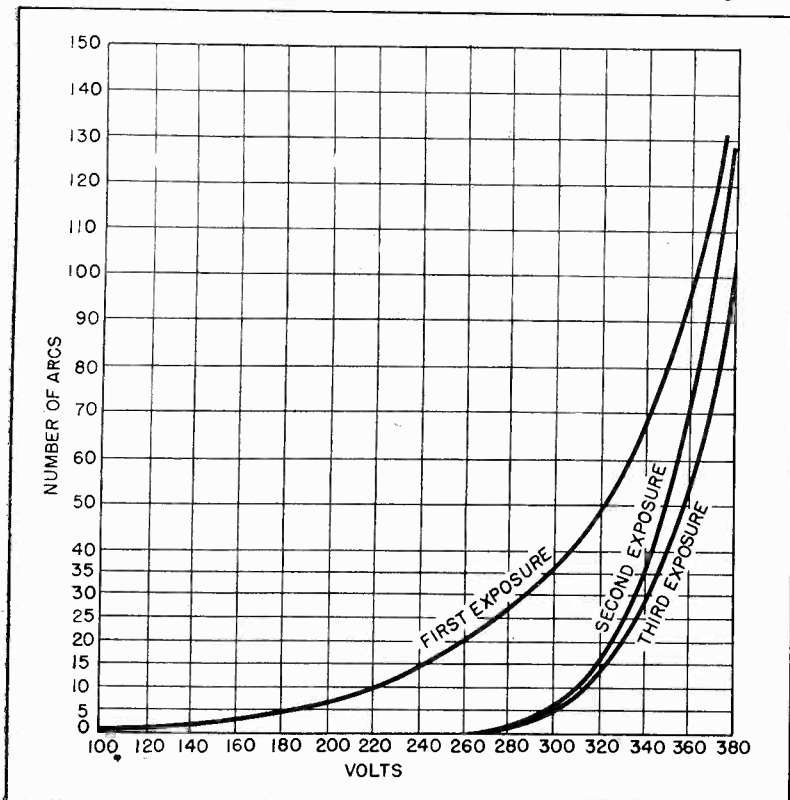

FIG. 3—The effect on a ten-ohm coating with a 50,000-ohm series resistance

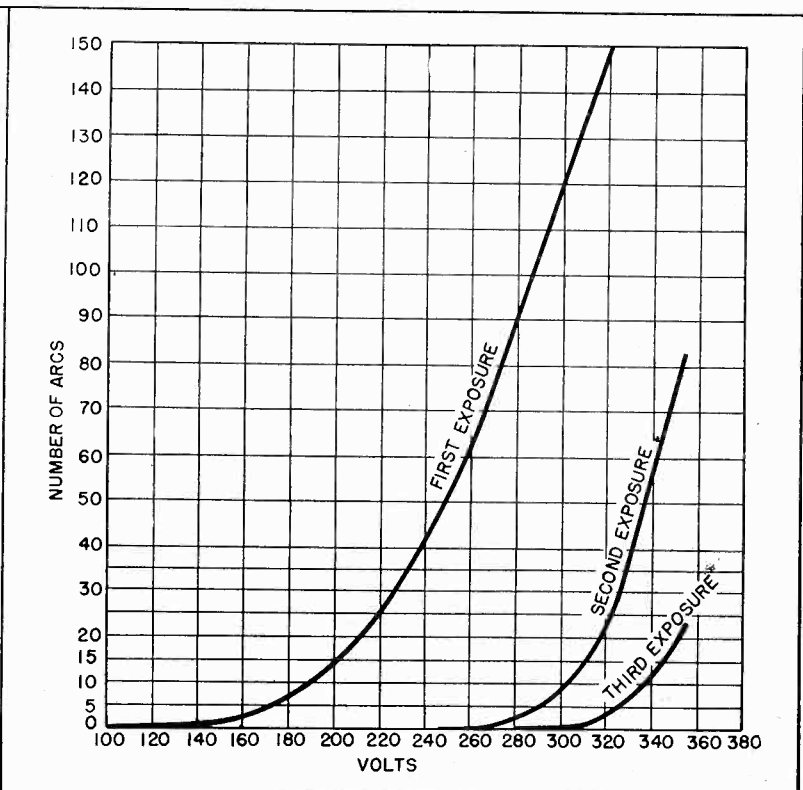

FIG. 4—Discharges through a 20-ohm coating and a 50,000-ohm series resistance

square inch. In the case of the untreated paper the size of the paper sample was approximately 2½ by 3 inches in rectangular form.

Dielectric constant measurements given in the table were calculated assuming a dielectric thickness of 0.4 mil for both the untreated paper and the metallized paper.

Table II

Dielectric Constant of Untreated Paper and Metallized Paper

Number of Paper Sheets	Paper Dielectric Constant	Metallized Paper Dielectric Constant (See Note 1)	Dielectric Constant (See Note 2)
20	2.55
15	2.42
12	2.33	4.40	3.36
10	2.26	4.23	3.27
9	2.20
8	2.11	3.92	3.06
7	2.05
6	1.93	3.66	2.84
5	1.82
4	1.70	3.14	2.44
3	1.51
2	1.37	2.43	1.92

(1) Arrangement of metallized paper electrode, zinc coating, paper, paper, zinc coating, zinc coating, paper, paper, zinc coating, and so forth, to the other electrode depending upon the number of sheets in the sample under test.

(2) Arrangement of metallized paper: electrode, zinc coating, paper, zinc coating, paper, and so forth, to the other electrode depending upon the number of sheets in the sample.

Preparation of Sample

In the case of the metallized paper samples, the sample was cut in a circular form approximately 2½ inches in diameter. Tests made on larger size samples indicated that the capacitance measurements were a function of the size of the sample. This was probably due to the fact that the coating increases the electrode area to something larger than the metallic electrodes themselves. Thus it was considered desirable to reduce the size of the sample to approximately the same as the electrode diameters. They were made slightly larger than the electrodes themselves to eliminate possible difficulties due to slight fraying that is obtained at the cut paper edge.

The dielectric constant values given in Table II are averages from a number of measurements. The

actual capacitances in any measurement depend upon humidity conditions prevailing at that time and also upon the effectiveness of contact made with the sample.

The resistance of the metal coating is much greater than the usual aluminum foil that is used for electrode material in the manufacture of impregnated paper capacitors. Accordingly, it is important to consider the effect of the increased resistance of the electrode material on the capacitor constants. The principal effect would be on the series resistance or power factor of the capacitor.

The increase in power factor of a paper capacitor using metallized paper may be given as follows:

Assume a capacitor unit as shown in Figure 5.

- f is frequency in cycles per second.
- R_m is resistance in ohms of metallic coating one-inch wide by 12 inches long.
- L is length of capacitor section in feet.
- W is active paper width in inches.
- C is capacitance in μf of a capacitor having one inch active paper width, one mil thickness of dielectric and one foot long.
- P is per-unit power factor (dissipation factor) of capacitor.
- C_t is total capacitance in μf of a capacitor section for length L feet.
- T is paper thickness in mils—total thickness of dielectric between electrodes.
- ϵ' is dielectric constant of material (3.5).
- ΔP is percent increase in power factor P of capacitor due to resistance of metallic coating.

$$\text{Then } C = \frac{0.224 \epsilon' (12)}{0.001} 10^{-6} = 0.0094 \text{ microfarad (1)}$$

$$\text{In Fig. 5, } C_s = \frac{C_t}{2} = \frac{CLW}{2T} \text{ in microfarads (2)}$$

$$X_s = \frac{10^6}{2\pi f C_s} = \frac{10^6 T}{\pi f CLW} \text{ in ohms (3)}$$

$$R_s = P X_s = \frac{PT 10^6}{\pi f CLW} \text{ in ohms (4)}$$

$$R_t = R_m \frac{L}{2W} \text{ in ohms (5)}$$

$$\text{Then from Eq. 4 and 5 } \Delta P = 100 \frac{R_t}{R_s} = \frac{50 R_m L^2 \pi f C}{PT 10^6} \text{ (6)}$$

Substituting L from Eq. 2 into Eq. 6 and C from Eq. 1 into Eq. 6 gives

$$\Delta P = \frac{0.017 R_m f T (C_t)^2}{P W} \text{ (7)}$$

For a capacitor to be used at a frequency of 60 cycles per second, an electrode width of two inches, a dielectric thickness of one mil, a metallic coating having a resistance

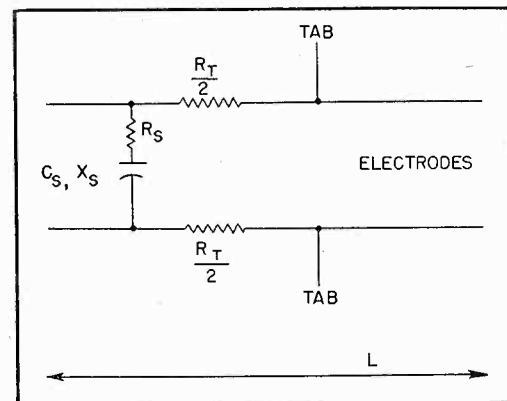

FIG. 5—Electrical factors of a metallized capacitor, for power factor calculation

of ten ohms for a strip one inch wide by 12 inches long and the dielectric power factor being 0.5 percent or 1005 per unit, a capacitor having a capacitance of 0.044 μf would have a ΔP of one percent. For a capacitor with this rating, the power factor as measured across its terminals would be 0.505 percent. The limit in capacitance C_t for any other given percentage increase in power factor ΔP can readily be obtained from Eq. 7, since the increase in power factor is proportional to the square of the capacitance.

Capacitors depending upon voltage rating and total capacitance may be built up from a number of individual units connected in series or parallel. For S series sections and N parallel sections the increase in power factor ΔP , due to the resistance of the metallic coating, is given by

$$\Delta P = \frac{0.017 R_m f T (CS)^2}{P (WN)} \text{ (8)}$$

in which C is the total capacitance in microfarads as measured across the external terminals.

For most applications it is believed that the additional series resistance due to the metallic coating as compared to aluminum foil would not significantly affect the constants of capacitors using metallized paper. In addition, the unit may be designed to minimize such effects.

REFERENCES

- (1) Henderson, Fred E., Metallized Paper Fixed Capacitor Units by the Robert Bosch Co., U. S. Dept. of Commerce Report.
- (2) Mansbridge, G. F., U. S. Patent 920,970 (1909)—Borgars, S. J., Richards, J. H., Brereton, K. G., Cotton, J. H., Grouse, R. A., Hunt, C., Scarratt, J. P., Whiley, C., Metallized Paper Capacitors U. S. Department of Commerce Publication Report PB-39361, p 23.
- (3) Lorentz, Egon; Weikel, Joanne; Norton, Sue Gray; *Review of Scientific Instruments*, 17, p 276, 1946.

COMPARATOR for

High-frequency line impedance measurements in laboratory or field can be simplified by this compact comparison instrument that essentially replaces the slotted coaxial line and sliding-probe voltmeter technique for checking match or determining standing-wave ratio and reactive component

IN matching a load with several adjustable elements, such as an antenna array, to coaxial transmission lines the process may prove to be tedious using the conventional slotted line and probe indicator. At low frequencies such lines become long and inconvenient to construct.

The simple instrument illustrated in Fig. 1 is a comparator consisting of a coaxial T-junction with a current pickup loop symmetrically placed to couple magnetically to the center of the junction. The T-junction joins the generator, the load whose characteristics are to be obtained, and a line terminated with a resistance or reactance equal to its characteristic impedance.

Electrostatic shielding between the coaxial lines and the loop is provided by a number of slots cut in each of the three lines near the center of the junction. The loop may be rotated in the plane of the junction to assume the various positions shown in Fig. 2. The output of the loop is fed to an indicator

such as a linear receiver. Assembled and exploded views of the completed comparator are shown in Fig. 3 and 4.

Standing-Wave Ratio

Referring to Fig. 5 the three lines have a common voltage \bar{E} at the center of the T-junction. Hence the impedance of the load line at the junction L is

$$\bar{Z}_L = \bar{E}/\bar{I}_L \quad (1)$$

Since the opposite line is matched,

$$Z_c = \bar{E}/\bar{I}_c \quad (2)$$

and

$$\bar{I}_L = \bar{I}_c (Z_c/\bar{Z}_L) \quad (3)$$

The impedance at a voltage minimum is a pure resistance equal to the product of the standing-wave ratio P and the characteristic impedance Z_c of the line, where P is taken to be the ratio of the minimum voltage to the maximum voltage.

By means of the usual impedance

transfer equation the impedance may be determined in terms of the resistance at a voltage minimum X located a distance of ρ electrical degrees on the load line.

$$\bar{Z}_L = \frac{P Z_c + j Z_c \tan \rho}{Z_c + j P Z_c \tan \rho} Z_c \quad (4)$$

Combining Eq. 3 and 4

$$\bar{I}_L = \bar{I}_c \left(\frac{1 + j P \tan \rho}{P + j \tan \rho} \right) \quad (5)$$

With the loop in position D (Fig. 2) parallel to the load and matched lines, a voltage will be induced in the loop producing a current \bar{I}_D , proportional to the vector difference of the load and matched line currents.

$$\begin{aligned} \bar{I}_D &= T (\bar{I}_L - \bar{I}_c) = \\ &= (T \bar{I}_c) \left(\frac{1 + j P \tan \rho}{P + j \tan \rho} - 1 \right) = \\ &= (T \bar{I}_c) \frac{(1 - P)(1 - j \tan \rho)}{(P + j \tan \rho)} \quad (6) \end{aligned}$$

where T is a proportionality constant depending upon the frequency, physical dimensions of the comparator components, and the input impedance of the receiver.

After rectification in the re-

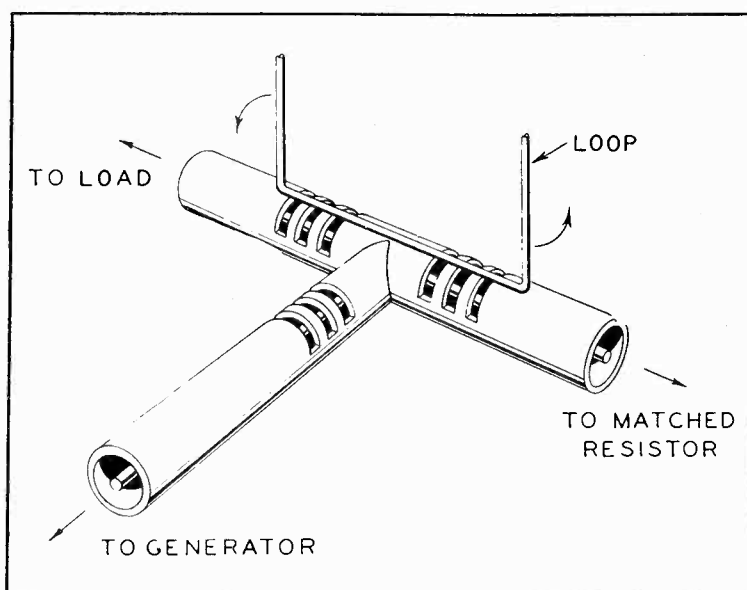

FIG. 1—Simplified drawing of T-junction, showing connections and the pickup loop that can be rotated to couple to them

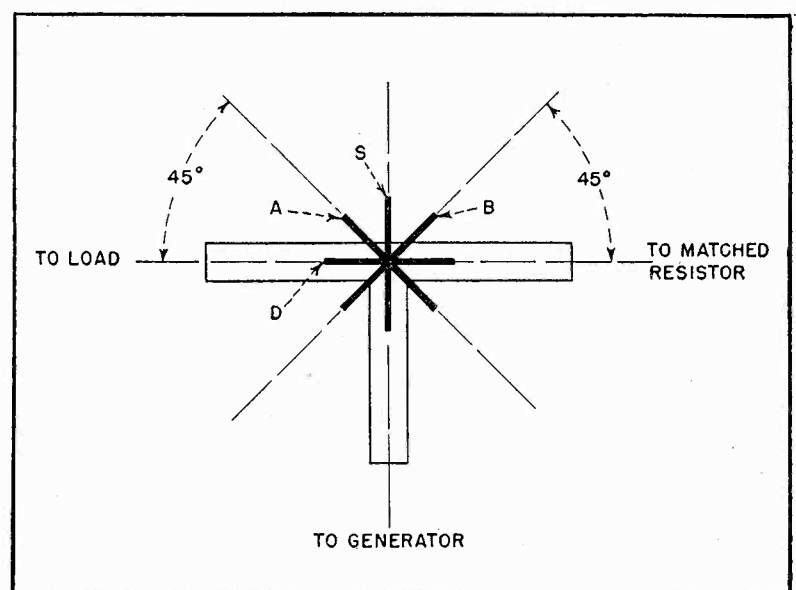
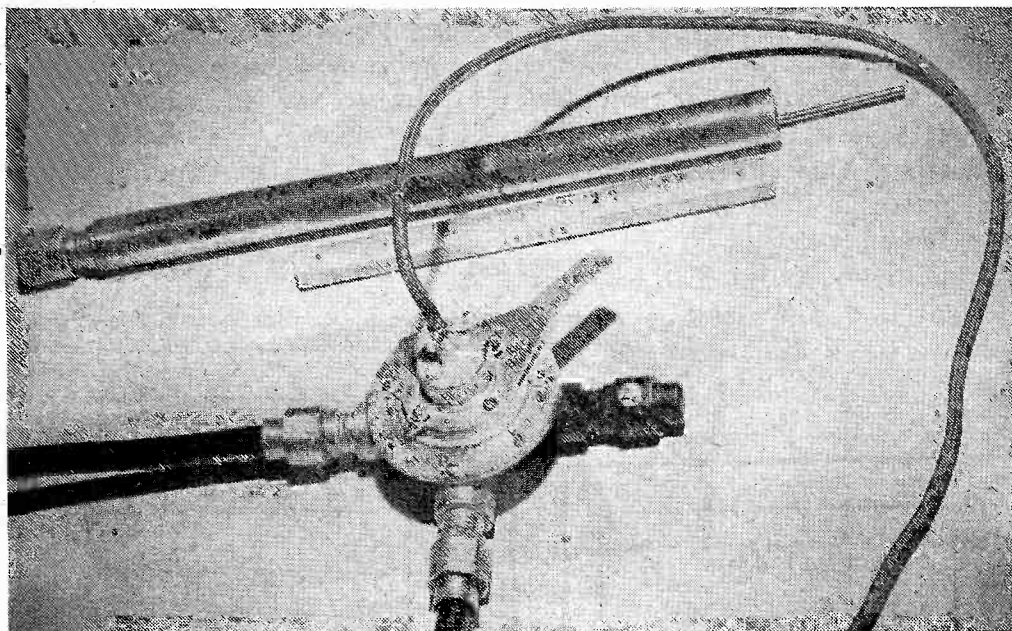

FIG. 2—Detail of the pickup loop positions with relation to the junction, and the notation used in designating position

Coaxial Line Adjustments

By O. M. WOODWARD, Jr.
RCA Laboratories
Princeton, N. J.



LEFT

FIG. 3—The shorted one-eighth wave coaxial line at the top replaces the matched resistor when determining the algebraic value of the load reactance

BELOW

FIG. 4—Exploded view. Slotted openings in the T-junction cover provide electro-static shielding between the junction (upper center) and the rotating loop at right

ceiver the output current I'_D will be proportional to the absolute magnitude of Eq. 6, or

$$I'_D = T' |I_o| \left(\frac{1 + \tan^2 \rho}{P^2 + \tan^2 \rho} \right)^{1/2} (1 - P) \quad (7)$$

where the proportionality constant T' also includes the receiver gain factor. Similarly, with the loop in position S parallel to the generator line a voltage will be induced in the loop producing a current \bar{I}_S proportional to the vector sum of the load and matched line currents.

$$\bar{I}_S = T (\bar{I}_L + \bar{I}_o) = (T \bar{I}_o) \frac{(1 + P)(1 + j \tan \rho)}{(P + j \tan \rho)} \quad (8)$$

The receiver output current will then be

$$I'_S = T' |I_o| \left(\frac{1 + \tan^2 \rho}{P^2 + \tan^2 \rho} \right)^{1/2} (1 + P) \quad (9)$$

$$\frac{I'_D}{I'_S} = \frac{1 - P}{1 + P} = K \quad (10)$$

The ratio of the receiver output currents for the two coil positions is equal to the magnitude of the reflection coefficient K on the load line.

In practice, the loop is placed in position S and the receiver gain or generator power adjusted to produce full-scale reading on the receiver output meter. The loop is then rotated to position D and the reflection coefficient is directly indicated on the meter as the percentage of full-scale reading. Equation

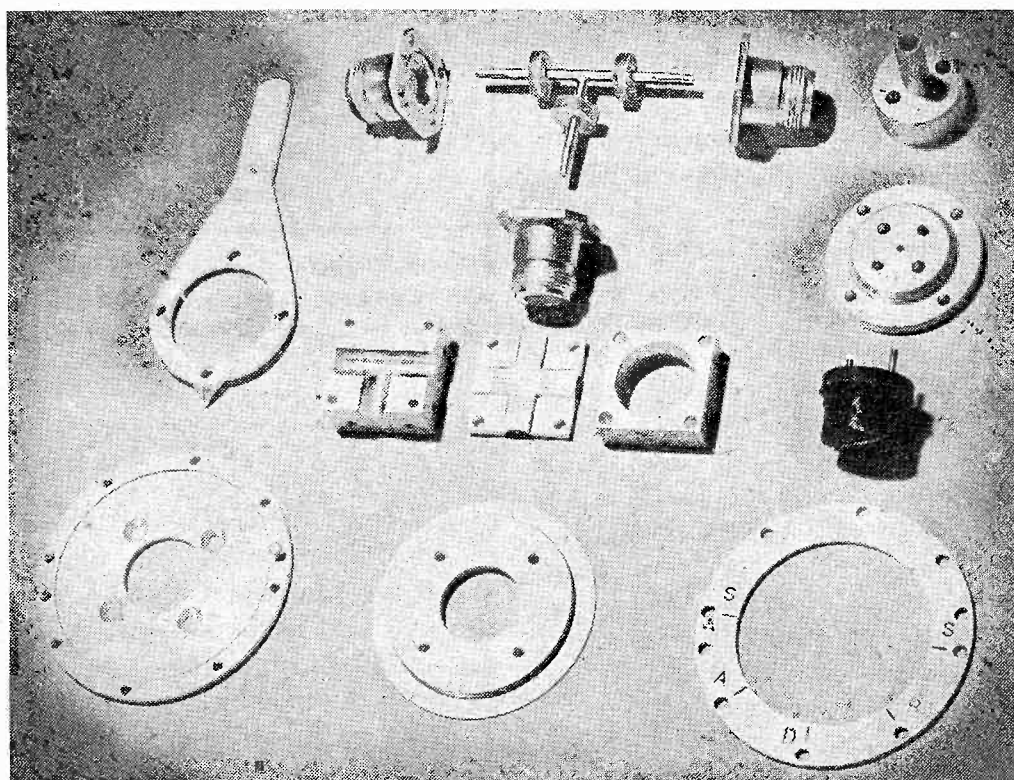

10 shows that the reflection coefficient reading obtained is independent of the relative position of the standing wave with respect to the comparator. If the receiver is not linear, suitable correction of the meter calibration must be made.

This relationship also may be shown in another manner. The loop currents for the two positions D and S are

$$\bar{I}_D = T (\bar{I}_L - \bar{I}_o) = \frac{T \bar{E}}{Z_L} \left(1 - \frac{\bar{Z}_L}{Z_o} \right) \quad (11)$$

and

$$\bar{I}_S = T (\bar{I}_L + \bar{I}_o) = \frac{T \bar{E}}{Z_L} \left(1 + \frac{\bar{Z}_L}{Z_o} \right) \quad (12)$$

The well-known transmission line equation expressing the current at a point down the line in terms of the load characteristics and line constants is

$$I_p = \underbrace{\frac{I_L}{2} \left[1 - \frac{\bar{Z}_L}{Z_o} \right]}_{\text{Reflected wave}} e^{\gamma P} + \underbrace{\frac{I_L}{2} \left[1 + \frac{\bar{Z}_L}{Z_o} \right]}_{\text{main wave}} e^{-P \gamma} \quad (13)$$

Hence the ratio of the receiver output currents for the two loop positions D and S is seen to be the ratio

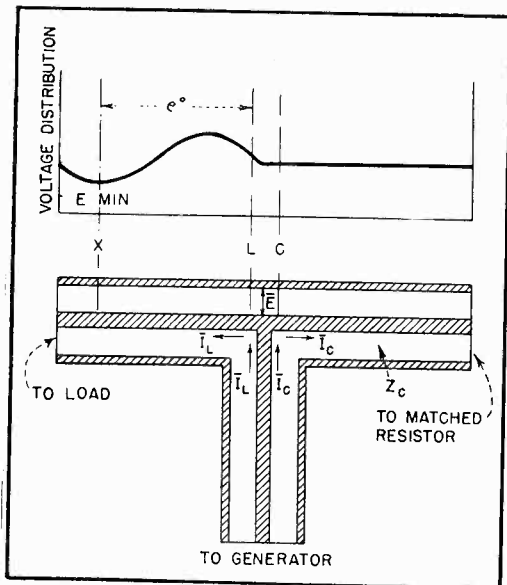

FIG. 5—Graphical representation of the standing wave formed on one arm of the T-junction when the load is not matched

of the reflected wave to the main wave, or the coefficient of reflection.

$$\frac{I'_D}{I'_S} = \left| \frac{1 - \frac{\bar{Z}_L}{Z_c}}{1 + \frac{\bar{Z}_L}{Z_c}} \right| \quad (14)$$

Assuming that a matched line may be provided, correct operation is independent of frequency up to the range where the loop couples to an appreciable fraction of a wavelength on the lines. In this region the loop current will not be a function of the currents flowing in the lines at the immediate T-junction only.

To obtain an experimental check on the accuracy of operation, a slotted measuring line was inserted between an adjustable load and the comparator. Standing-wave ratio readings obtained from the two instruments for various loads and frequencies are comparable as shown in Fig. 6 and 7.

Fixed Loop for Matching

For certain applications, such as final matching adjustments of antennas in the field, the comparator may be simplified by fixing the loop in position D. In use, the load matching elements are adjusted in rotation for a null on the receiver output meter. Referring to Eq. 7 it is seen that a null is obtained only when P is unity.

A comparator of this type covering the frequency range of 400 mc to 1,700 mc, in which the receiver is replaced by a fixed crystal and microammeter for simplicity,

is shown in Fig. 8. The loop consists of an adjustable quarter-wave tuning stub to which is coupled the fixed crystal. The matched load is a selected resistor equal to the characteristic impedance of the lines used. The exploded view (Fig. 9) shows the construction of the electrostatic screen and other component parts. Although simpler in construction, this modification of the comparator does not indicate the degree of mismatch.

For a given standing wave on the load line the load current and hence the loop current will be

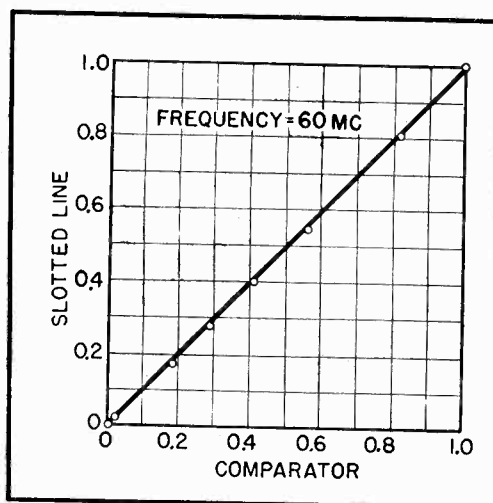

FIG. 6—Standing-wave ratios obtained with a slotted line inserted between adjustable load and comparator at 60 mc

a function of the relative position of the standing wave with respect to the T-junction. If the line between the load and the comparator is of such a length as to give a voltage minimum at the T-junction ($\phi = 0$) the loop current from Eq. 7 is seen to be proportional to $(1-P)/P$. For the same load a change in line length of one-quarter wavelength will result in a voltage maximum appearing at the T-junction ($\phi = 90$), and the loop current will be proportional to $(1+P)$.

The ratio of the minimum loop current to the maximum loop current for a given load and a variable shift of the standing-wave along the load line is seen to be equal to the standing-wave ratio.

$$\frac{I_{D \text{ min.}}}{I_{D \text{ max.}}} = \frac{(1-P)}{(1+P)/P} = P \quad (15)$$

Thus, as a match is approached on the load line by adjustment of the

matching elements, the possible meter deflection diminishes rapidly.

Using a square-law crystal detector the relative meter deflection as a function of the standing-wave ratio and its position on the load line is plotted in Fig. 10. The shaded area indicates the possible deflection change for any shift of the standing wave along the line. A constant T-junction voltage E is assumed for these calculations.

Absolute Magnitude of Load Impedance

Other load characteristics may be obtained from the comparator

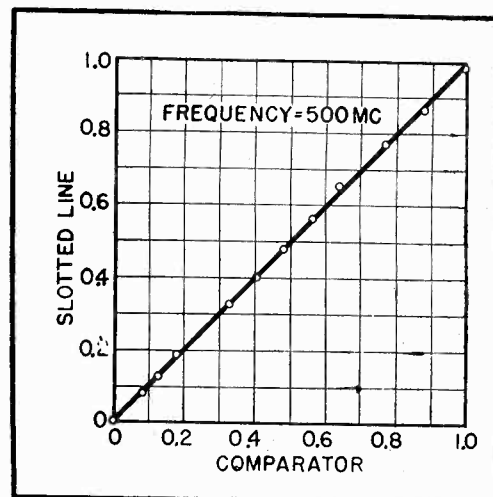

FIG. 7—Good agreement is found at 500 mc between slotted-line and comparator measurements of standing-wave ratios

with the rotating loop. The absolute magnitude of the load impedance $|Z_L|$ at the T-junction is found by taking the ratio of the linear receiver output readings for two additional loop positions. From Fig. 2 it is seen that with the loop in position B the loop current is

$$\bar{I}_B = T \left(\frac{\bar{I}_c}{\sqrt{2}} + \frac{\bar{I}_c}{\sqrt{2}} \right) = \sqrt{2} T \bar{I}_c \quad (16)$$

since the loop is at an angle of 45 degrees and couples equally with both of the T lines. Components of the load current in the loop are equal and opposite in this case. Similarly, with the loop rotated 90 degrees to position A, the current is

$$\bar{I}_A = T \left(\frac{\bar{I}_L}{\sqrt{2}} + \frac{\bar{I}_L}{\sqrt{2}} \right) = \sqrt{2} T \bar{I}_L \quad (17)$$

Forming the ratio and combining with Eq. 3,

$$\frac{I'_B}{I'_A} = \frac{|Z_L|}{Z_c} \quad (18)$$

where $|Z_L|$ is expressed in terms of the characteristic impedance of the lines. In practice the receiver output meter is set to full scale at the loop position giving the larger reading. The loop is then rotated 90 degrees to the other position and the ratio of $|Z_L|/Z_c$, or $Z_c/|Z_L|$ as the case may be, is read directly on the meter as the percentage of full scale deflection.

Resistive Component of Load Impedance

Having obtained the reflection coefficient K and the absolute magnitude of the load impedance $|Z_L|$ from the four loop positions, the resistive component R_L of the load impedance may be found. From Eq. 4

$$\frac{\bar{Z}_L}{Z_c} = \frac{P + j \tan \rho}{1 + j P \tan \rho} = \frac{R_L + j X_L}{Z_c} \quad (19)$$

Equating the real terms and imaginary terms respectively

$$R_L - X_L P \tan \rho = Z_c P \quad (20)$$

and

$$R_L P \tan \rho + X_L = Z_c \tan \rho \quad (21)$$

Eliminating $\tan \rho$ and solving for R_L/Z_c

$$\frac{R_L}{Z_c} = \left(\frac{P}{P^2 + 1} \right) \left[\left(\frac{|Z_L|}{Z_c} \right)^2 + 1 \right] \quad (22)$$

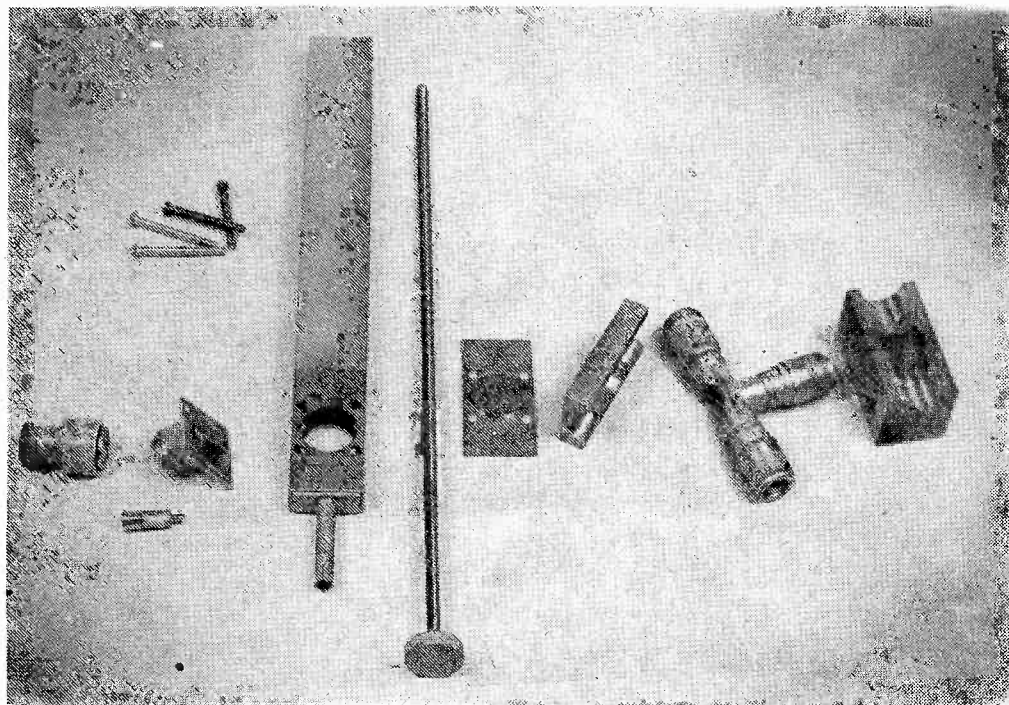

FIG. 9—Exploded view of the uhf comparator

since $P = (1 - K) / (1 + K)$

$$\frac{R_L}{Z_c} = \frac{(1 - K^2)}{2(1 + K^2)} \left[\left(\frac{|Z_L|}{Z_c} \right)^2 + 1 \right] \quad (23)$$

Although the arithmetic value of the reactive component X_L may be derived knowing R_L and $|Z_L|$, the algebraic sign of X_L is not found since the same loop reading of ρ and $|Z_L|$ will be obtained whether the reactive component is positive or

negative. Also for some values of the load impedance having a small phase angle, low accuracy is obtained in determining the arithmetic value of X_L .

To obtain the algebraic value of the reactance, the matched resistor (Fig. 5) is replaced with a shorted coaxial line one-eighth wavelength long having the same characteristic impedance Z_c as the T-junction lines. Since the reactance of the eighth-wave shorted stub is $+jZ_c$,

$$\bar{I}_c = \bar{E} / + j Z_c \quad (24)$$

$$\text{Hence } \bar{I}_c = \bar{I}_L \left(\frac{X_L}{Z_c} - j \frac{R_L}{Z_c} \right) \quad (25)$$

With the loop in position D,

$$\bar{I}_D = T (\bar{I}_L - \bar{I}_c) = T \bar{I}_L \left(1 - \frac{X_L}{Z_c} + j \frac{R_L}{Z_c} \right) \quad (26)$$

Likewise, with the loop in position S,

$$\bar{I}_S = T (\bar{I}_L + \bar{I}_c) = T \bar{I}_L \left(1 + \frac{X_L}{Z_c} - j \frac{R_L}{Z_c} \right) \quad (27)$$

Designating the ratio of the receiver output currents in this case by K'

$$K' = \frac{I'_D}{I'_S} = \left[\left(1 - \frac{2X_L}{Z_c} + \frac{|Z_L|^2}{Z_c^2} \right) / \left(1 + \frac{2X_L}{Z_c} + \frac{|Z_L|^2}{Z_c^2} \right) \right]^{1/2} \quad (28)$$

Solving for X_L/Z_c ,

$$\frac{X_L}{Z_c} = \frac{(1 - K'^2)}{2(1 + K'^2)} \left[\left(\frac{|Z_L|}{Z_c} \right)^2 + 1 \right] \quad (29)$$

The ratio of the receiver cur-

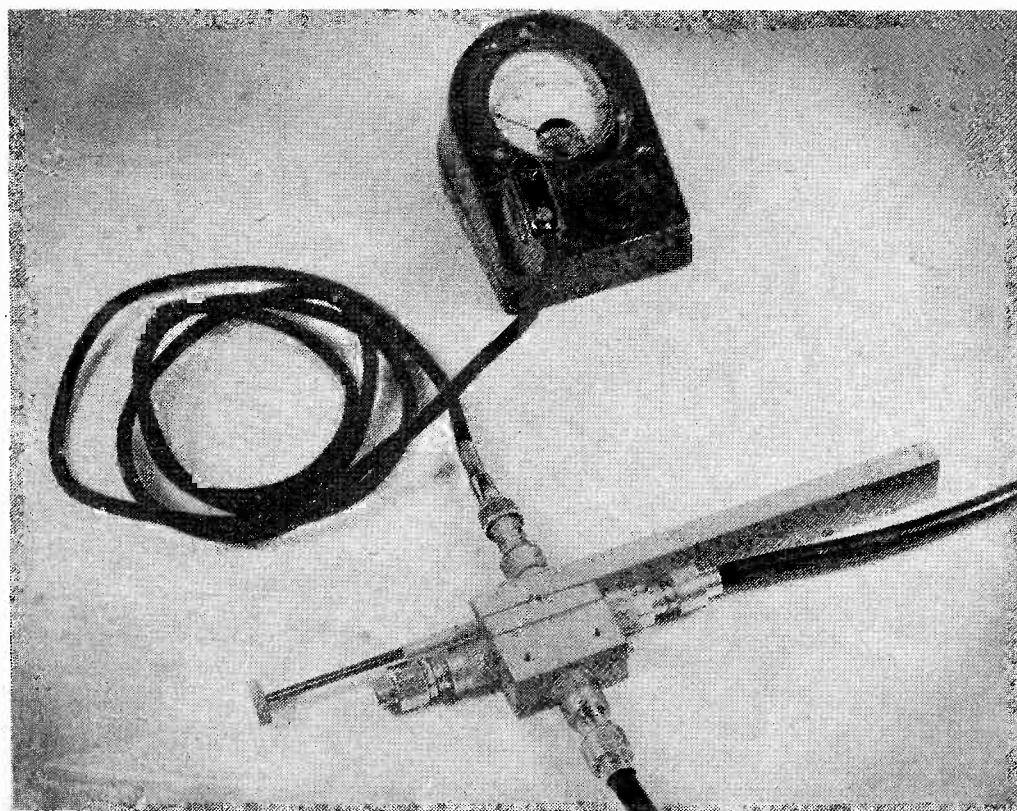

FIG. 8—A comparator designed for use in the frequency range 400 to 1,700 mc, using a self-contained fixed crystal detector and microammeter

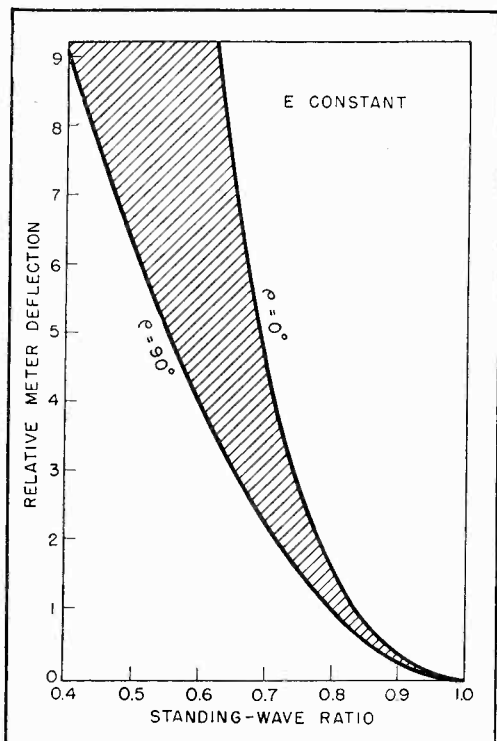

FIG. 10—Relative meter deflection shown as a function of standing-wave ratio and its position on the load arm of the T-junction

rents for the loop positions B and A will be the same whether the stub or the matched resistor is used. It is seen that the equations for the resistive component and the reactive component are identical in form. The adjustable stub may be calibrated in terms of frequency for convenience in use.

Since the reactance of a shorted line θ electrical degrees in length is given by

$$X = +j Z_c \tan \theta \quad (30)$$

it is seen that the stub may be somewhat shorter than an eighth-wave in length if its characteristic impedance is raised, the only requirement being that its reactance be equal to the characteristic impedance of the load line.

For a particular frequency of operation the stub length to give the required reactance may be found quite easily without the use of the slotted measuring line equipment. The load line is replaced by the stub, and the matched resistor connected to the opposite side of the comparator. Since it was shown in Eq. 18 that the absolute magnitude of the load impedance in terms of the characteristic impedance was equal to the ratio of the loop currents for loop positions B and A,

the stub is simply adjusted until this ratio is unity.

A chart is given in Fig. 11 from which the resistive and reactive components of the load impedance may be obtained from the various loop positions of the comparator.

Example

As an example of its use, an unknown load and the matched resistor are connected as shown in Fig. 2. The loop is rotated in the four positions to give the current ratios of D/S and A/B (or B/A). For a D/S ratio of 0.46 and a A/B ratio of 0.65 the resistive component of the load impedance in terms of the characteristic impedance is found to be 1.10. The matched resistor is then replaced by the eighth-wave stub and the current ratio D/S (or S/D) determined. Using the same A/B value of 0.65 previously found, it is seen that the reactive component of the load impedance in terms of the characteristic impedance is equal to

−0.75 for a S/D ratio of 0.62. For a characteristic impedance equal to 52 ohms the load impedance is then equal to

$$(1.10 - j0.75)(52) = 57.2 \text{ ohms} - j 39 \text{ ohms} \quad (31)$$

An adjustable impedance was measured with the comparator and the slotted line apparatus at a frequency of 200 mc to provide an experimental check of the accuracy of the comparator. The results are tabulated below.

Comparator	Slotted Line
18.3 + j 6.5	18.2 + j 6.5
44.7 - j 70.4	44.8 - j 67.2
36.2 - j 20.3	38.4 - j 19.3
58.3 - j 100.0	56.8 - j 101.0

Acknowledgment

The author wishes to acknowledge the useful suggestions and valuable contribution by Dr. G. H. Brown in the development of the comparator.

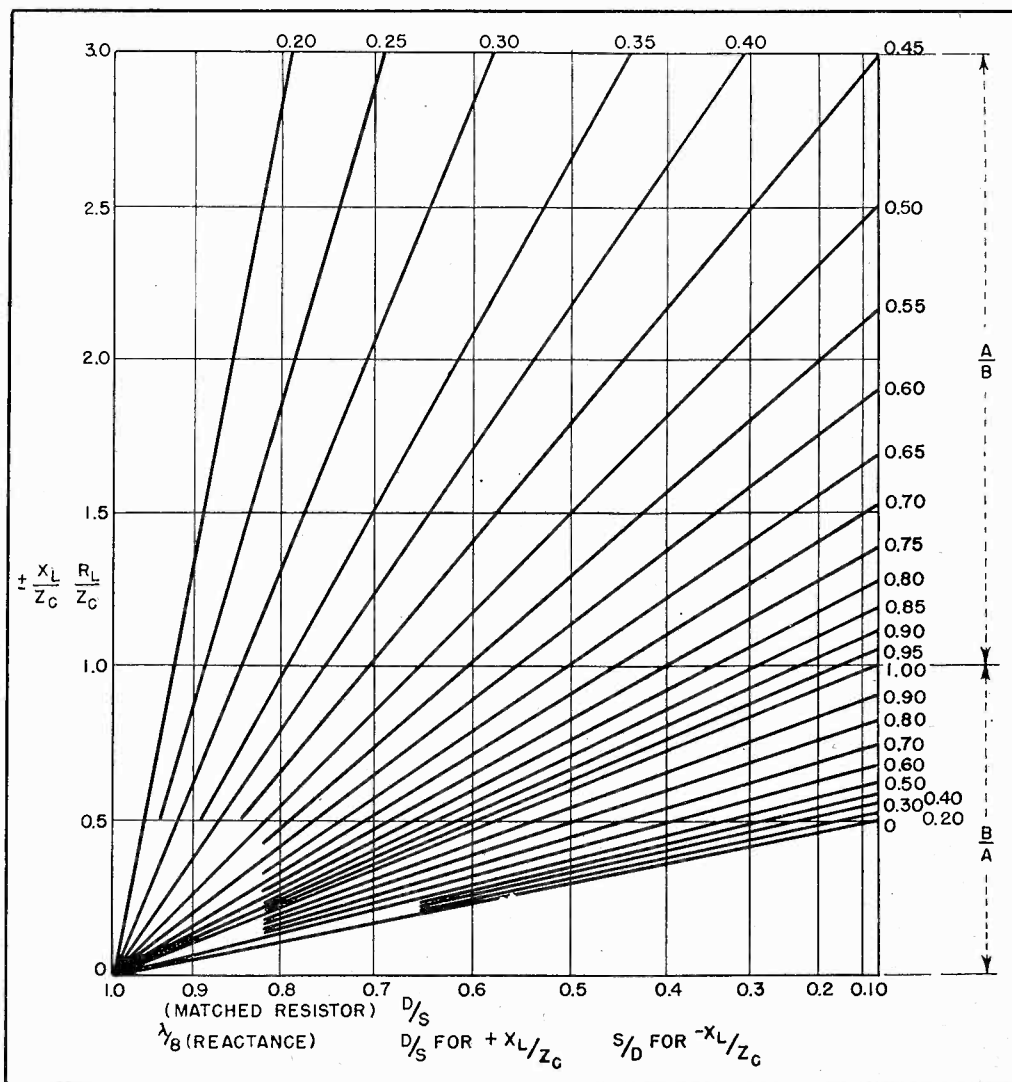
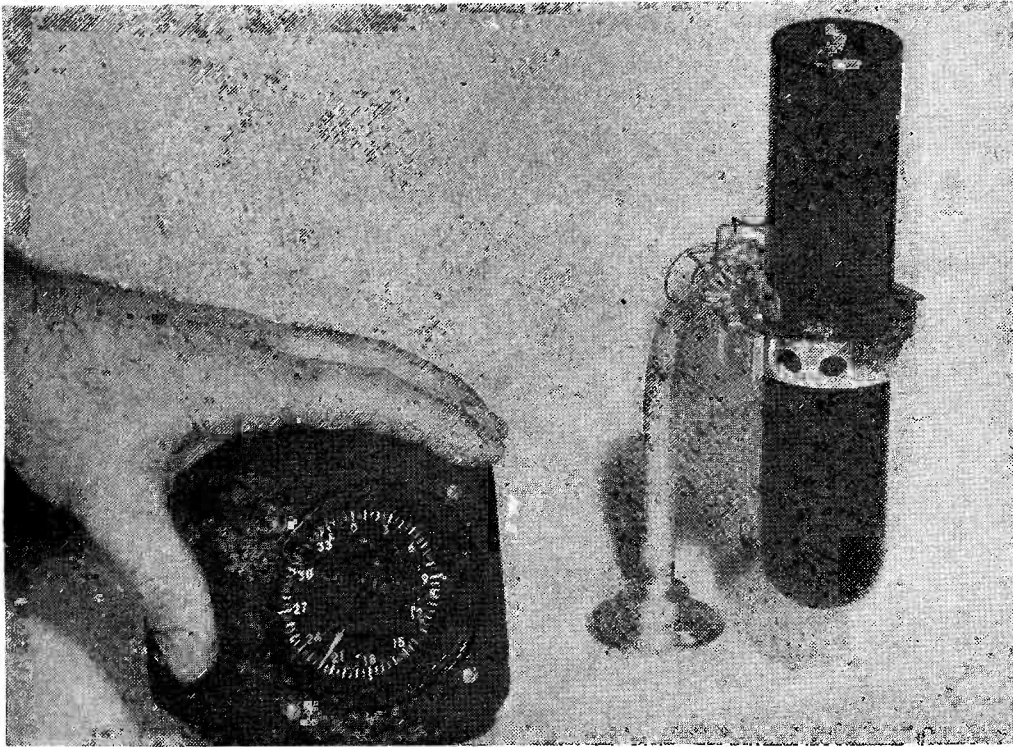

FIG. 11—Chart showing resistive and reactive components of the load impedance as obtained from various loop positions and detector voltage readings

Cathode-Ray Compass

Deflection by the earth's magnetic field of an electron beam impinging upon four targets produces varying target currents. These currents are amplified, resolved, and fed through a servomechanism to the autopilot gyroscope



The Cathotrol tube at the right is swung in gimbals and connected to the direct-reading indicator at left

By **RALPH T. SQUIER**

*Assistant Director of Research
Minneapolis-Honeywell Regulator Co.
Minneapolis, Minn.*

IF A DIRECTIONAL GYROSCOPE is to be used as a permanent reference for an autopilot and its excellent stabilizing characteristics utilized to the fullest extent, a means must be provided to eliminate errors caused by rotation of the earth, latitude effects, and precession introduced by friction in the tilt axis. Of the many possible types of compass that may be used in connection with an autopilot, an electron beam directed against a multiple target and deflected by the earth's magnetic field seems most feasible because it has negligible inertia and high sensitivity. A compass employing such a beam is also easy to manufacture and adjust.

The cathode-ray compass or Cathotrol employs a modified form of cathode-ray tube as its chief ele-

ment. Four targets are used. During the development of this tube it has been continuously reduced in size and there are no indications that the practical minimum has yet been reached. A cross section of the electron gun is shown in Fig. 1. The cathode-ray beam intensity is modulated at 400 cycles by means of the grid. Anode 1 is used as the accelerator and anodes 2, 3, and 4 are used as focusing electrodes. In this application it is necessary for the beam to strike the exact center of the targets when no magnetic field is applied. Since it is impossible to attain exact alignment of the components during assembly, small centering electrodes are placed ahead of the electron gun for final electrostatic adjustments.

The electron gun is located at one

end of the tube and the cathode rays strike four target plates located at the opposite end as shown in Fig. 2. These targets consist of four 90 degree sectors. With no magnetic deflection the cathode ray strikes the center of these targets and equal amounts of current pass through all target sectors.

The tube is mounted in gimbals, suspended so that the electron beam is perpendicular to the surface of the earth and therefore at right angles to the horizontal component of the earth's magnetic field.

Theory of Operation

The vertical component of the earth's field has no effect on the cathode ray in normal operation since the beam is directed towards the center of the earth. The horizontal component of the earth's field always deflects the beam toward the west if the beam is directed downward. The amount of this deflection varies with latitude, but the only consequence is a

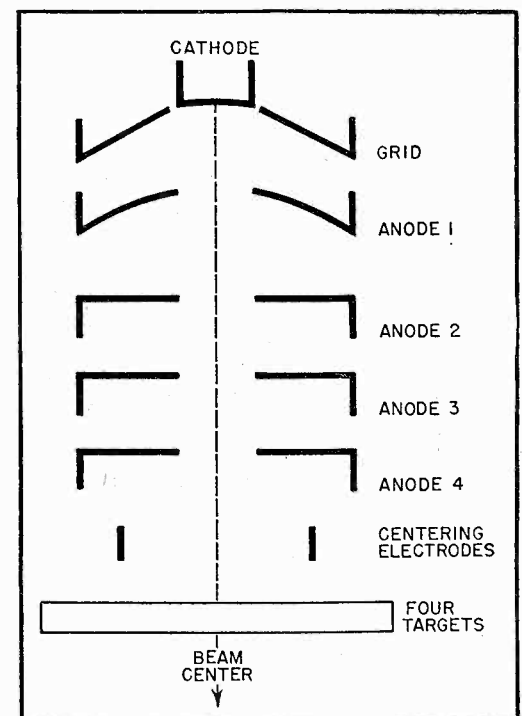

FIG. 1—Cross section of the electron gun, showing position of the elements

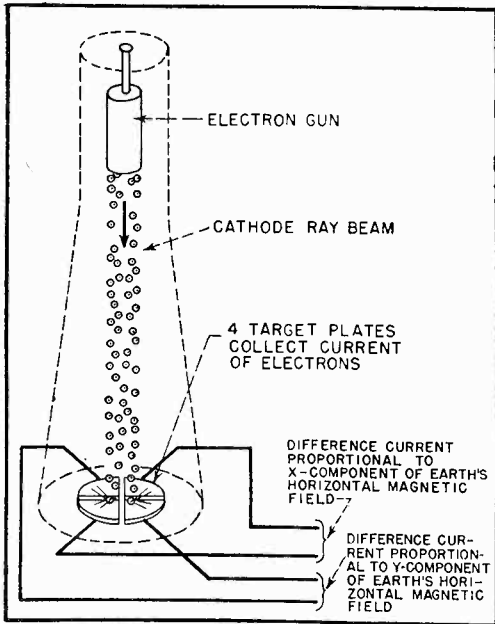

FIG. 2—Simplified diagram of the tube, showing relative position of the electron gun and the target plates

change in sensitivity. As the tube turns, the beam remains stationary, but the targets turn, thus changing the currents collected by the individual sectors. The relation of the beam to the target plates indicates the amount of rotation of the tube.

Opposing target plates are connected as shown in Fig. 3 through the primary of a transformer, the center tap of which is the B+ return of the tube. The output of each transformer is the difference between the 400-cycle currents to opposing targets and is proportional to the components of the magnetic field at right angles to a line through the center of these targets.

The tube is so oriented in the airplane that a line through the centers of two opposing targets is parallel to the longitudinal axis of the plane and a line through the other plates would be parallel to the lateral axis. The output of the two transformers is then proportional to the two components H_x and H_y of the earth's horizontal field, and it is possible to obtain the plane's magnetic heading. In order to convert this information into the plane's heading, square potentiometer resolvers are used. The only restrictions in their design are that the turns of wire must be parallel, the wipers must wipe in a complete circle, and their electrical and geometric centers must coincide.

The voltage applied across the X potentiometer by its transformer is

proportional to the X component of the earth's field or $V_x = 2KH \cos \theta$, when K is a constant depending on deflection sensitivity, focal spot and transformer characteristics; H is the horizontal component of the earth's field; and θ is the angle between earth's field and plane heading. Similarly, the voltage across the Y potentiometer is $V_y = 2KH \sin \theta$. The potentiometer wipers are 90 degrees apart. Hence, the voltage between one wiper and the center of its potentiometer varies as the sine of ϕ and the voltage between the other wiper and the center of

its potentiometer varies as the cosine of ϕ , where ϕ is the angle of rotation of the wiper from the zero position.

The output of the two wipers is

$$V = V_x \sin \phi - V_y \cos \phi$$

Replacing V_x and V_y by their equivalents

$$V = 2KH \cos \theta \sin \phi - 2KH \sin \theta \cos \phi$$

When

$$\theta = \phi, V = 0$$

Since the two wipers are connected mechanically and rotate together it is possible to find a position where the output V is zero. When this condition is achieved the

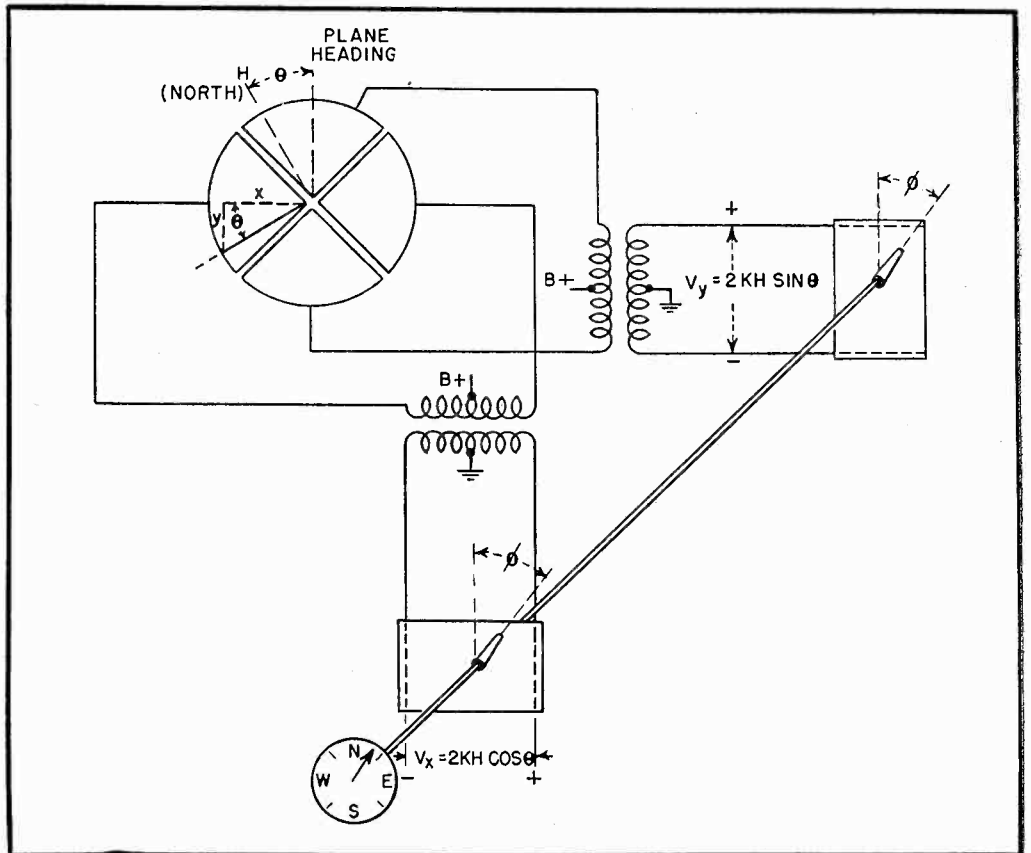

FIG. 3—Resolving portion of the system showing targets, transformers, and resolvers connected by a common shaft to the indicator

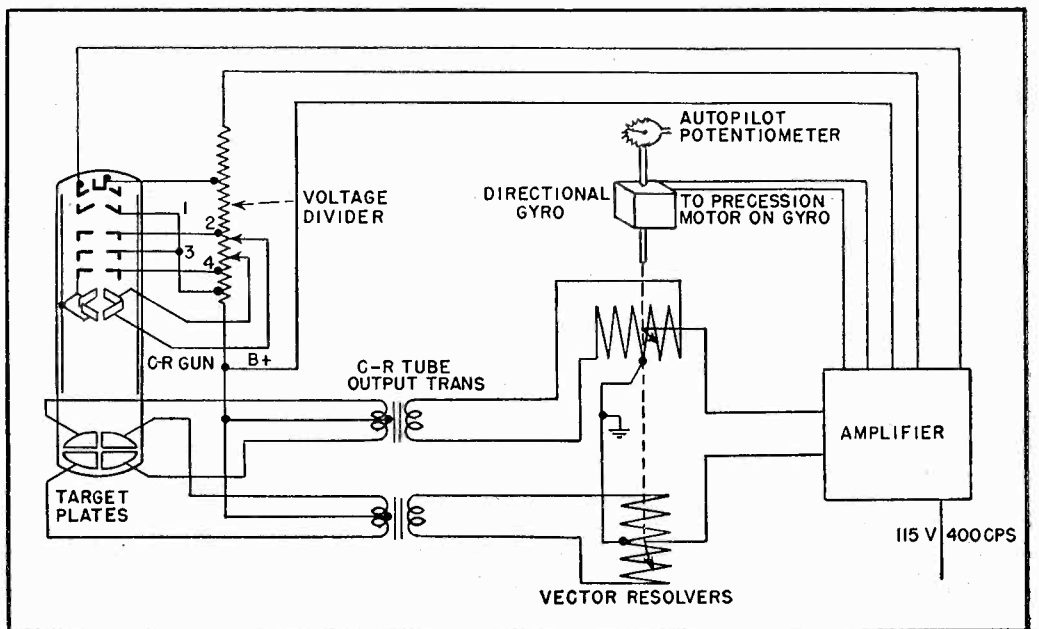

FIG. 4—Complete navigational system for accurate directional flight, showing the interconnection between gyro and compass resolver; precession motor and autopilot potentiometer

angle ϕ of the potentiometer is equal to θ and is therefore the angle between the magnetic field and the plane's heading. When ϕ and θ are not equal a voltage is applied, the sign of which depends upon whether θ is greater or less than ϕ . This output then is fed into an amplifier and a discriminator and into a servomotor that precesses the directional gyroscope until the two angles are again equal. This connection is shown in Fig. 4.

The two potentiometer wipers are mounted on the vertical axis of the directional gyroscope. The potentiometers themselves are secured to the case. As long as the directional gyroscope and the compass are aligned no signal is fed into the precession motor. As the plane turns the potentiometers move to a new position relative to the wipers. As they are being moved, however, there is a difference, voltage being supplied to the two potentiometers which exactly compensates for this movement and the output is still zero.

Connection to Autopilot

Fastened to the gyroscope case, but with means provided for circular movement, is a center-tapped autopilot potentiometer with its wiper fastened to the vertical axis of the gyroscope. When the wiper is off center the output voltage is fed into a discriminator amplifier and then into the autopilot. The servos then turn the airplane until the autopilot potentiometer is on center again.

It is possible to turn the autopilot potentiometer mechanically to a new heading. The autopilot potentiometer wiper will pick up a signal and turn the airplane to the new heading. The compass and the directional gyroscope still maintain their original relationship and there will be no precession signal from the cathode-ray compass. When the gyroscope precesses to an erroneous position a voltage appears on the autopilot potentiometer wiper which turns the plane to an erroneous heading. However, there now appears across the compass potentiometers a change in voltage that is proportional to the magnitude of the off-course angle. The gyroscope is then precessed by the compass

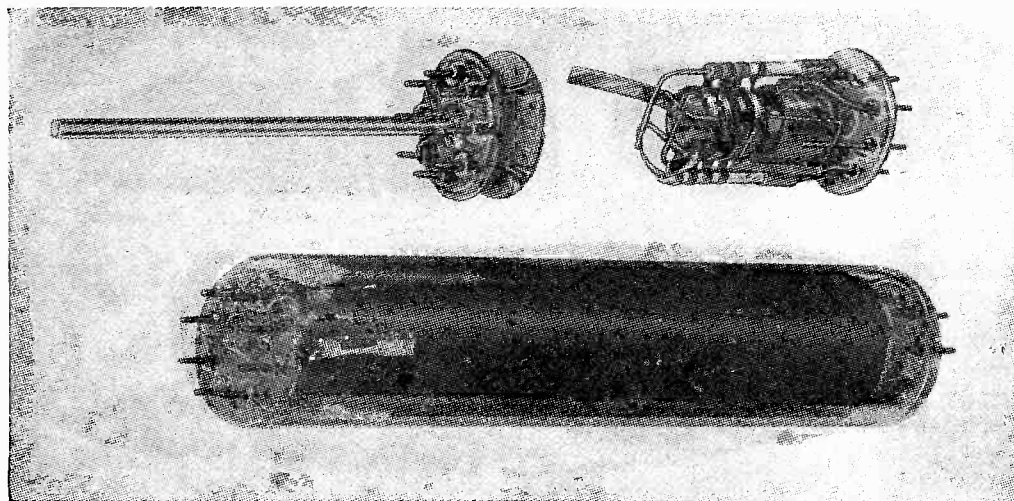

The tube out of its protective case, with target element (left) and electron gun (right) shown in detail above. The tube is one inch in diameter and seven inches long

until the compass potentiometers' output is zero. A voltage of opposite polarity appears on the autopilot potentiometer wiper and the plane is returned to its original heading.

Accuracy

This compass, like many others that depend upon the horizontal component of the earth's magnetic field, is mounted pendulously in gimbals in order that the electron beam be perpendicular to this field. Because of this mounting it occasionally is subjected to oscillations that introduce small errors caused by the vertical component of the earth's field. If the output of the amplifier is fed into relays the error resulting from oscillations will occur first in one direction and then in the other depending entirely on time, and the integrated result will be zero. If the output of the amplifier is fed directly into the precession motor a modulated precession is achieved. Since the errors are linear up to plus or minus 2 or 3 degrees the throttling range is restricted to these limits. High angular momentum and low precession rate of the gyroscope and short period of oscillation of the compass tube result in a zero integrated error.

Although voltage changes are encountered in aircraft the compass must not be affected by them. With voltage changes of 25 percent the changes in angle have been consistently less than $\frac{1}{2}$ degree. It is also reasonably independent of changes in field intensity. The output is linear with magnetic field intensities from zero up to values

well above the maximum terrestrial field, so that the compass can easily measure angles to the desired accuracy.

Since compasses are not read to better than ± 1 degree it did not seem advisable to design one better than this. Therefore the present model was designed so that the errors are well within ± 1 degree around the 360 degree circle. The sensitivity is better than 0.25 degree (off-course signal necessary to produce a correction) and the consistency of holding a course then is much better than 1 degree. There is no northerly turning error of the type found in needle compasses.

Other useful applications are foreseen for the device. The compass tube can be driven in both axes to align itself with the earth's field. This effect might be helpful in determining dip and latitude. By using rebalance coils it can measure intensity and has already been used to detect fields as small as one-half milligauss.

The cathode-ray compass and the slave directional gyroscope system has been flown many thousands of miles and has satisfactorily demonstrated its ability to detect small changes in heading.

Acknowledgment

Many people have contributed to this development, and special acknowledgment is made to Dr. Waldo Kliever, Director of Research, Richard R. Syrdal, Senior Design Engineer, and Merle Ludwig, Design Engineer, all of Minneapolis-Honeywell Regulator Company, and Dr. Henry Hartig of the University of Minnesota.

TELEMETERING

From V-2 Rockets

Output of 1,000-mc receiver in ground station of time-modulated pulse telemetering system contains trains of pulses spaced according to instrument readings in rocket. Circuits for decoding these pulses into individual voltages for recording are given here

Part II

By V. L. HEEREN, C. H. HOEPPNER,* J. R. KAUCHE, S. W. LICHTMAN, and P. R. SHIFFLETT

Office of Research and Inventions, Naval Research Laboratory, Washington, D. C.

** Now with Glenn L. Martin Co., Electronics Lab, Baltimore, Md.*

THE first installment of this two-part paper covered the basic problem of telemetering instrumentation from a rocket during flights well up into the ionosphere. General details were given for the time-modulated pulse system developed by the Rocket Sonde Research Section of the Naval Research Laboratory to meet the limited allowance for size and weight of the rocket-borne equipment yet provide reliable telemetering over ranges in excess of 100 miles. Finally, the circuit of the airborne unit was presented and analyzed in detail. Ground station circuits will now be taken up.

The pulses transmitted from the airborne unit are received by the ground station antenna, amplified by the receiver, and passed on to the decoder units for separating the channels and presenting the channel information for analysis. The signal as received may contain signals other than those transmitted by the airborne unit, such as spurious noise peaks and radar interference. Therefore, the signal, upon entering the decoder, first passes into a pulse discriminator which limits receiver noise and distinguishes the proper pulses on the basis of their duration. Pulses of a duration greater or less than 0.8 microsecond are automatically eliminated at this point.

The circuit diagram of the pulse width discriminator in the ground

station decoder is given in Fig. 5, and pulse waveforms at various points in this circuit are shown in Fig. 6. The signal from the receiver, at point A, contains pulses of the proper duration as represented by pulse 2 in Fig. 6, pulses of insufficient duration as represented by pulse 1, pulses of excessive duration as represented by pulse 3, and receiver noise. During operation, potentiometer R_1 in Fig. 5 is adjusted so that the bias on the grid of V_1 is low enough to limit the average receiver noise and yet allow pulses to cause V_1 to conduct.

The inverted signal on the anode (at B) is coupled to the grids of two normally conducting triodes, V_{2A} and V_{2B} . When V_{2A} conducts, its anode is at a negative potential with respect to ground, keeping V_3 cut off. A negative pulse at point B renders V_{2A} nonconducting for the pulse duration, but the rate of potential rise of its anode is limited by the charging rate of the shunt capacitance C_A through R_2 and R_3 , as illustrated at C in Fig. 6. Only pulses with the proper duration or greater allow point C to rise high enough to cause V_3 to conduct. The negative pulse developed on the anode of V_3 is coupled to the coincidence tube V_4 through a short time constant circuit. Only the positive surge generated at a point E can have any effect on V_4 because point E is normally at cutoff potential. The effect on V_4 also depends

on the coincidence signal at point G.

A negative pulse at point B renders V_{2B} nonconducting as it did V_{2A} , and the rate of potential rise at point F is also limited. Because the anode of V_{2B} is normally at a lower potential than that of V_{2A} by virtue of the difference in cathode potentials, it takes a pulse of greater duration to allow V_{5A} to conduct than it does to allow V_3 to conduct. The limits have been designed so that only pulses of excessive duration cause V_{5A} to conduct and cause a negative pulse at point G. Thus for input pulses of excessive duration, the positive surge on point E at time t_0 has no effect on the anode of V_4 , because of the coincident negative surge at point G.

Input pulses of the proper duration produce a positive surge at point E without the blocking negative surge at point G, but the resulting signal at point H is not in as stable a form as desired. Tubes V_{5B} and V_6 are added to convert the positive surge at point E to a stable, uniform pulse to be passed to subsequent decoder circuits.

When a pulse of proper duration is received, the positive surge at point E causes a negative surge to appear at point H which is coupled to the grid of the normally conducting tube V_6 and cuts it off. A positive surge appears at point K, and the common cathode bias developed by current through R_6 drops

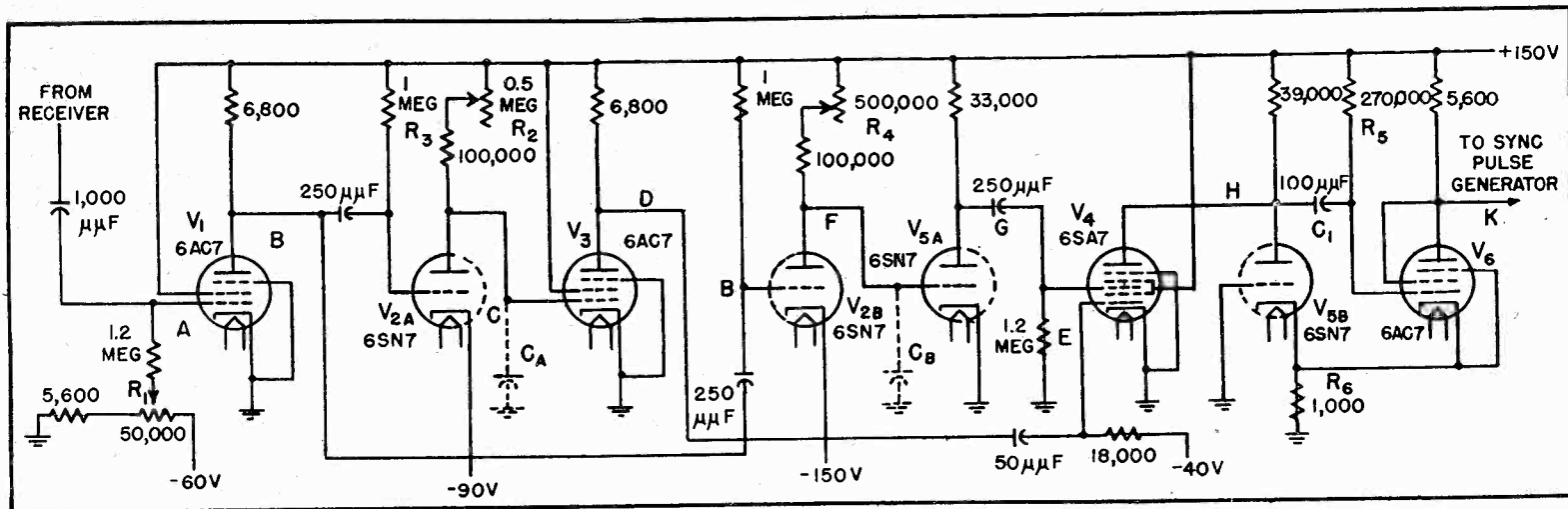

FIG. 5—Circuit of pulse width discriminator used in ground station of V-2 rocket telemetering system

until V_{5B} conducts, causing an additional negative surge at H to hold the grid of V_6 below cutoff.

Tube V_{5B} continues to conduct after V_4 ceases conduction, and point H is held down. The potential on the grid of V_6 immediately begins to rise according to the exponential charging rate of C_1 with current flowing through R_5 . When the potential at this point reaches the control region of the grid, V_6 conducts, common cathode bias is produced, V_{5B} is cut off, and a positive surge appears at point H , driving V_6 to full conduction and causing a negative surge to appear at point K . The values of C_1 and R_5 have been designed so that the duration of the positive pulse at K is from 7 to 10 microseconds.

The range of discrimination can be controlled from the pulse discriminator panel by adjusting R_2 and R_4 . The values of these resistances control the charging rate of C_A and C_B and therefore control the pulse durations required to cause V_3 and V_{5A} to conduct as at C and F in Fig. 6. Control R_2 sets the minimum limit of the duration of the acceptance band, which can be from 0.75 to 10 microseconds. Maximum control R_4 can be set to pass from 0.8 to 12-microsecond pulses.

Shunt capacitances C_A and C_B are created by leads and tube elements.

The Decoder

The circuit diagram in Fig. 7 shows the remaining stages of the decoder in the ground station, along with two of the metering channels, and Fig. 8 gives waveforms at various points in the circuit. The video signal from the pulse width discriminator to the

decoder is very similar to the form of the signal as it left the pulse-time modulator in the airborne unit, and the sequence of operations in the decoder is very closely the reverse of what occurs in the pulse-time modulator.

The first decoder operation is that of generating a synchronizing pulse marking the beginning of each sampling group. This marker provides a means of directing each channel to its proper output. The relatively long period between pulse groups offers the means of generating the synchronizing pulse.

During the period in the sequence just before a pulse group is received, tube V_2 is nonconducting but its anode is held to ground potential because of current flowing to the grid of tube V_{3A} . At time t_1 (Fig. 8), the first pulse in the ensuing pulse group causes V_2 to conduct fully during the pulse;

because of the high resistance of R_1 , the anode potential drops very close to the cathode potential, discharging C_1 in the process. The grid of V_{3A} , now far below its cutoff potential, begins to rise slowly as C_1 becomes charged with current through R_1 . However, the time necessary to charge C_1 through R_1 is long enough to assure that the grid of tube V_{3A} does not reach the conducting region before pulse 2 occurs, at which time tube V_2 again discharges C_1 .

This sequence is repeated until the last pulse in the group is reached, tube V_{3A} remaining nonconducting all the while. The interval from the last pulse of one group to the first pulse of the next is long enough to allow the potential at point C to rise until tube V_{3A} conducts. Conduction begins at time t_x in Fig. 8.

The values of C_1 and R_1 are chosen to make the start of conduction occur approximately 400 microseconds after the last pulse of a group arrives. Conduction then continues until the first pulse of the next group arrives and the cycle is repeated. Signals D and E are therefore generated on the anodes of V_{3A} and V_{3B} . Signal D occurs at very nearly the same position in the cycle as signal A in Fig. 4 of Part I. Signal D serves the purpose in the decoder that signal A does in the airborne pulse-time modulator.

Channel Separator Circuits

Signal D of Fig. 8 is at the input of the channel 1 separator, which is designed to generate positive pulse H , beginning at time t_1 and ending at time t_2 for every pulse group. The positive surge of sig-

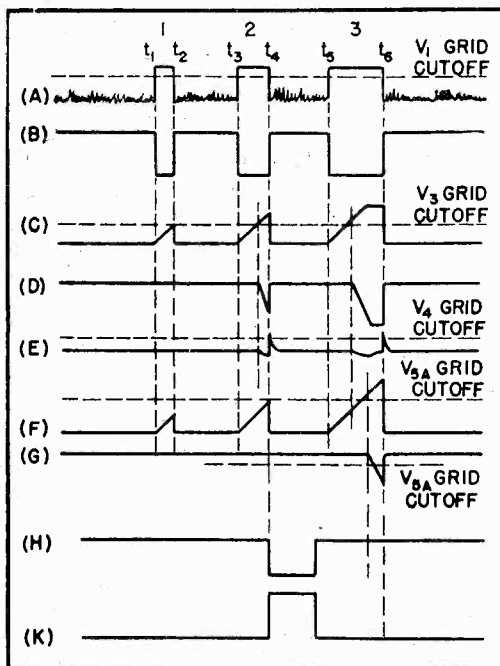

FIG. 6—Waveforms at various points in pulse width discriminator circuit of Fig. 5

nal D occurring at t_1 initiates this action, but the only signal from which t_2 can be obtained is signal A , which must first be inverted by tube V_1 before being coupled to the separator.

Channel 1 separator is a blocked multivibrator consisting of V_{4A} , V_{5A} , and V_{5B} . Tube V_{5B} normally conducts fully, causing a positive cathode bias on V_{5A} . The grid of V_{5A} is returned to ground through R_2 , keeping V_{5A} cut off. The negative pulses at point B do not affect the conduction of V_{5A} because of the positive cathode bias.

Signal D is coupled to V_{4A} through a small time constant circuit, and appears at point F in the form shown at F in Fig. 8. The positive surge causes V_{4A} to conduct, producing a negative surge at point G and at the grid of V_{5B} . This tube is cut off, causing a positive surge at H and removing the positive bias on the cathode of V_{5A} . Simultaneously a negative pulse occurs at B which would pre-

vent the complete triggering of the multivibrator were it not for the fact that the positive pulse at point F is of greater duration than the negative pulse at B . At the termination of the negative pulse at B , the cathode bias has not yet been restored; therefore, V_{5A} becomes conducting as V_{4A} becomes nonconducting. The low potential at the anode of V_{5A} and the grid of V_{5B} is therefore retained, keeping tube V_{5B} cut off.

The multivibrator remains in this temporary condition until negative pulse 2 occurs at point B at time t_2 . Current in tube V_{5A} is then cut off; a positive surge occurs at point G , causing the grid of V_{5B} to rise; V_{5B} conducts, and a negative surge occurs at point H . The cathode bias returns and V_{5A} stays cut off, further negative pulses at B having no more effect until the cycle is repeated. This process generates the signals at G and H on the anodes of V_{5A} and V_{5B} . Since the time $t_2 - t_1$ is the

measurement interval of channel 1, the signal at H contains channel 1 data entirely separated from the data of other channels.

Channel 2 separator functions exactly like channel 1 separator, with signal G initiating the action at time t_2 in the same manner that signal D initiated action in channel 1 separator at time t_1 . The output of channel 2 separator (signal M) contains successive measurements from channel 2 entirely separated from the other channels. Subsequent channels operate in the same manner, using a signal from each preceding channel to initiate the action, and using signal B to stop the action. The cycle continues until the last channel separator action is completed, and the system then remains quiet until the next pulse group is received.

Metering Circuits

The function of the metering circuits in Fig. 7 is to convert the information as it appears at point

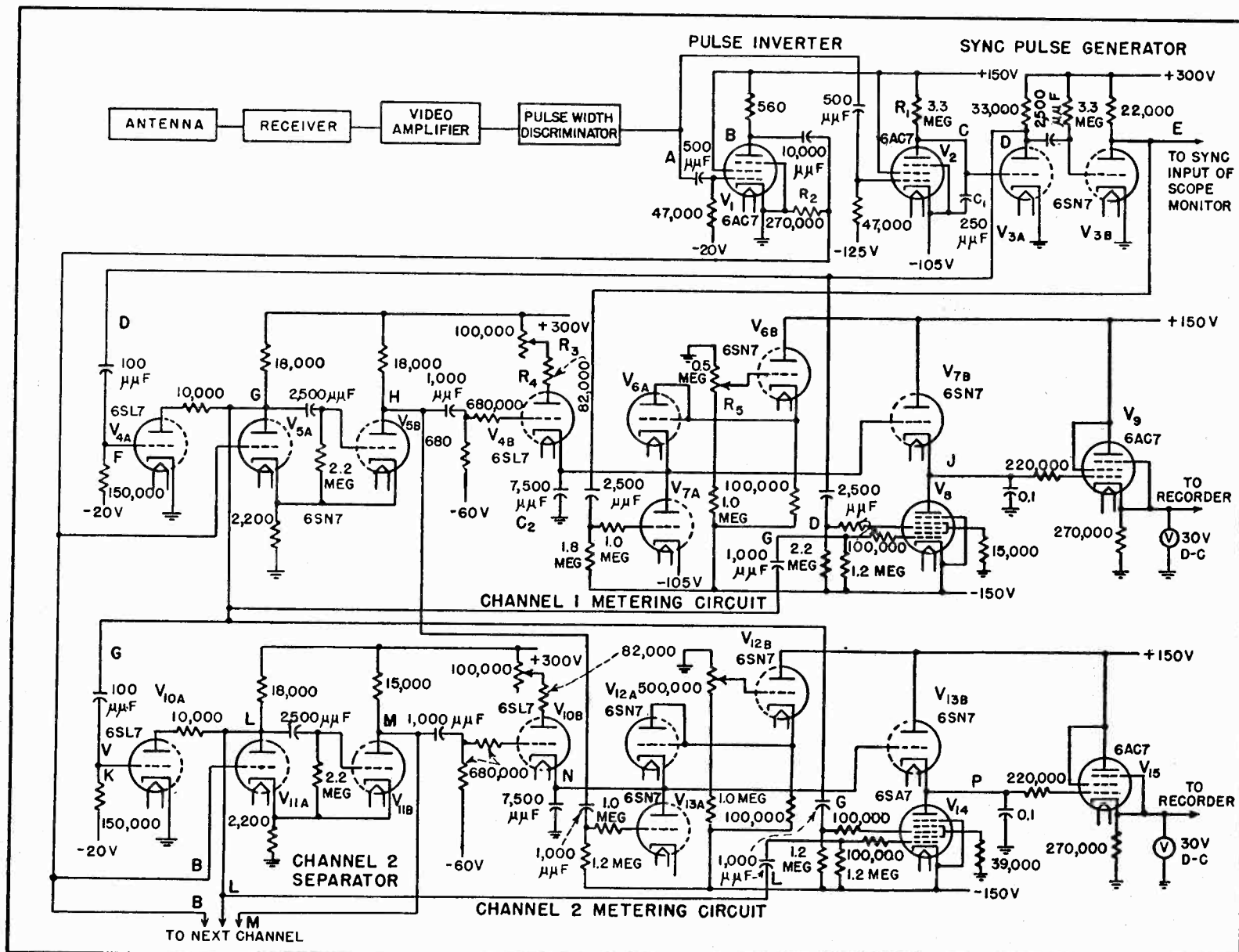

FIG. 7—Circuit of decoder and two of the metering channels for the ground station

H , M , etc, to voltages whose values are the same as those originally transmitted. Converting the duration of the positive pulse at H to a voltage requires the use of a capacitor which charges at an approximately linear rate for the duration of the pulse. In channel 1 metering circuit, C_2 is charged in such a manner, with current passing through V_{6B} which is normally cut off except for the duration of the positive pulse H . Capacitor C_2 begins to charge from the same reference potential on each cycle.

Just before C_2 begins to charge, point I is brought down to the reference level by tubes V_{6A} , V_{6B} , and V_{7A} . Tube V_{7A} , which is normally cut off, conducts from time t_x until t'_1 because of the positive signal E at that time, and C_2 is thereby discharged to the reference level determined by V_{6B} . The cathode potential of this tube is supplied from a low impedance; therefore, when the potential of point I falls to the cathode potential, diode V_{6A} immediately clamps point I at the reference potential. Point I remains in this condition until time t'_1 when V_{7A} is cut off and V_{6B} begins conducting. The potential of point I rises according to the charging time of C_2 with R_3 , R_4 , and the resistance of V_{6B} . At time t'_2 V_{6B} is cut off and point I becomes isolated at the final potential that it reached during charging. This potential is held until t'_2 , when the next positive pulse at E occurs and point I is again discharged, repeating the cycle.

The signal which appears at point I is shown in Fig. 8. The intelligence of channel 1 has been reconverted to a steady voltage at this point except for the discontinuity from time t_x until t'_2 . This discontinuity is removed by the action of V_{7B} and V_8 . Tube V_{7B} acts as a cathode follower and V_8 , which normally conducts, acts as the cathode resistor of V_{7B} . Point J follows any level set at point I except during the discontinuity. Point J cannot follow the potential at I during its drop to the reference level since the cathode resistor, tube V_8 , is rendered nonconducting during that interval. Signal D on one of the control grids keeps V_8 cut off from time t_x until t'_1 , and

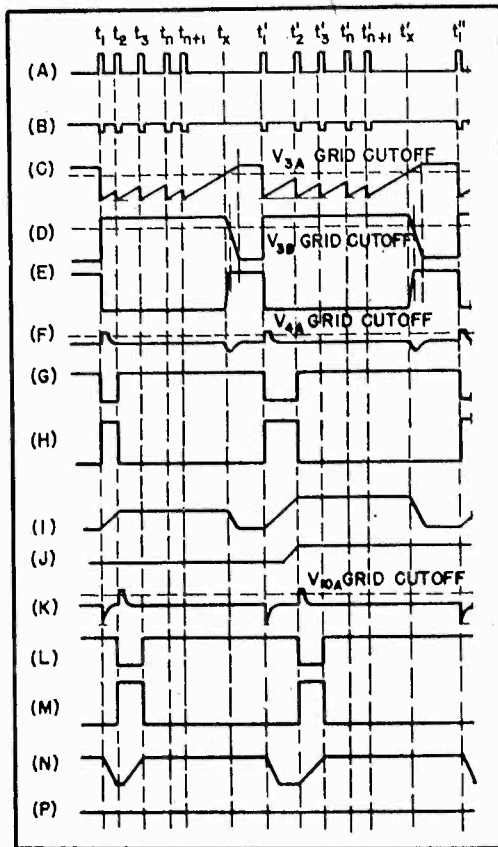

FIG. 8—Waveforms at various points in the decoder circuit of Fig. 7

then signal G keeps it cut off from time t'_1 until t'_2 . Thus the voltage at J remains at a constant value until a new level has been reached at point I .

The voltage at J without the discontinuity is much more preferable for recording than the voltage at I . It is, therefore, the voltage J which is passed through cathode follower V_9 to the various recording instruments.

The metering circuits for the succeeding circuits operate in the same manner, except that where signals D and E operate in channel 1, signals G and H will operate in channel 2, signals L and M will operate in channel 3, and signals of the same sequence operate from channel to channel for all succeeding channels.

The output circuits are capable of supplying currents up to 10 milliamperes for the recording instruments. The manner in which the output completely follows signals which change rapidly from cycle to cycle is shown at J in Fig. 8, and the manner in which the output remains constant when the signals are unchanged from cycle to cycle is shown at P .

To align the telemetering system, adjustments are provided in each metering circuit. Potentiometer

R_5 is adjusted so that the meter reads zero when the channel input leads to the airborne transmitter are grounded. Potentiometer R_3 is adjusted to give full-scale deflection of the meter when 5 volts is applied. After these adjustments are made, a curve of output versus input is run with points at half-volt intervals. This curve is referred to the calibrating voltage and a complete record of alignment is then preserved.

Response and Accuracy

The response of the system to change in data voltage is limited by the telemetering sampling rate. It is still possible, however, to obtain data from voltages varying at a rate higher than the sampling rate. The telemetering link responds fully in any period to the instantaneous data voltages at the moment of sampling. The string galvanometers of the recorder respond to frequencies up to 1,000 cycles. Of course, specific attention must also be given to the response characteristics of the instrumentation for the various experiments.

The use of calibration voltages eliminates errors due to change in the overall response of the system, replacing a relatively indeterminate error by one which is easily estimated. The use of a voltage regulator tube in conjunction with a resistance divider makes it possible to maintain the calibration voltage constant to within ± 1 percent.

It is not a simple matter to estimate the magnitude of error introduced into recovered data by the difficulties involved in reading the photographic record. The magnitude is plainly a function of the reader, the clarity of the record, the focus of the recording spot, and the magnitude of the maximum deflection. Combining data recovery errors with calibration errors, it appears that a calibrated accuracy of roughly ± 5 percent may be expected of the telemetering system. Future refinements in technique and equipment are expected to reduce the overall error to about ± 2 percent.

Finally, to the system errors there must be added those introduced by the instrumentation of the various experiments.

Electronic Switch for

By **G. R. SMITLEY**
and
R. E. GRABER

Ordnance Research Laboratory
School of Engineering
The Pennsylvania State College
State College, Pa.

IN RECENT YEARS, laboratory work in the audio and ultrasonic frequency ranges has required the use of pulse techniques in many acoustical and electrical experiments. Various types of pulsers have been described in the literature¹. Five desirable characteristics, however, are not all included in the devices described to date. These desirable factors are:

- (1) Pulse length variable, by means of a calibrated adjustment, over a suitably wide range.
- (2) Pulse rate similarly adjustable over a suitably wide calibrated range.
- (3) Pulse length and rate adjustments entirely independent of one another.
- (4) Synchronizing pip for oscilloscope trace synchronization, the

pip occurring a suitable and adjustable length of time before the beginning of the pulse. Control independent of pulse rate and length.

- (5) A means for introducing a steady-state signal upon which required in studying high-gain

systems utilizing automatic volume control.

The device described below was built to meet the above requirements and for general laboratory use. In addition, the following specifications were set up and are fulfilled:

- (a) Pulse length, or closure

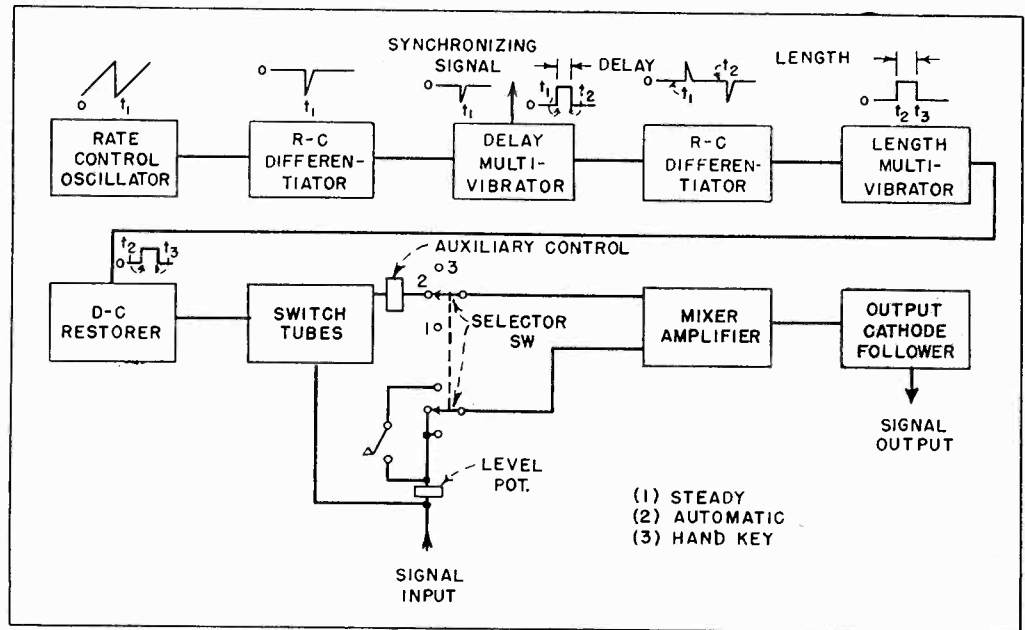

FIG. 1—Block diagram of pulser

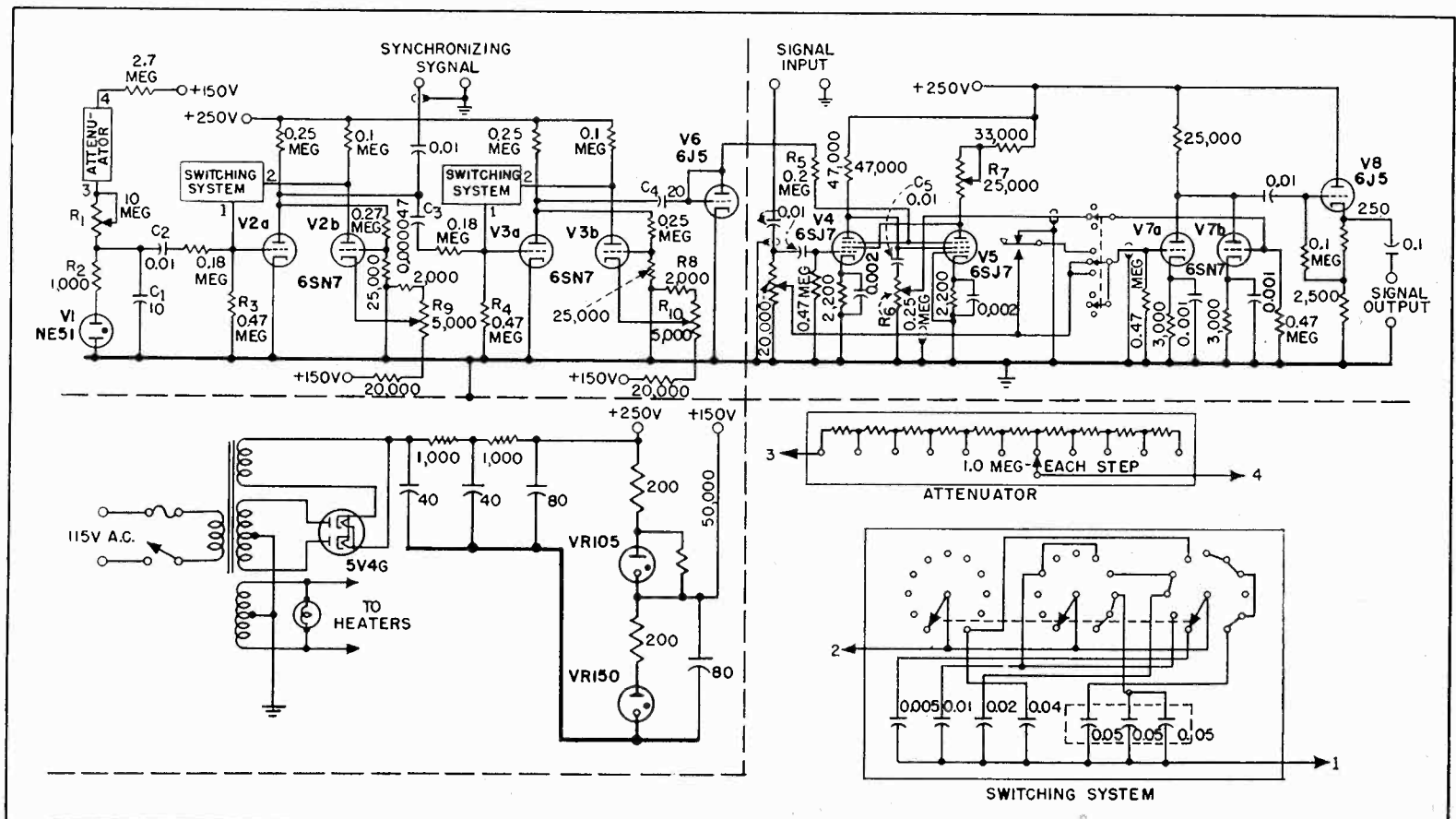

FIG. 2—Schematic diagram of pulser

the Production of Pulses

Circuit provides variable pulse length, variable pulse rate, variable delay of synchronizing pip, and a means for introducing a steady-state signal upon which pulses may be superimposed, in a generator designed for laboratory use

time, adjustable in steps between 5 milliseconds and 250 milliseconds.

(b) Pulse rate, or interval between closures, adjustable in steps between 0.6 second and 2.9 seconds, with an auxiliary control providing intermediate repetition rates throughout this range.

(c) Delay between the initiating pip, which is also used for oscilloscope sweep synchronization, and the start of the pulse adjustable in steps between 5 milliseconds and 250 milliseconds.

(All of the above adjustments are independent of one another).

(d) Frequency range of the signal to be switched, 1 kc to 100 kc.

(e) Maximum peak output voltage, approximately 5.

(f) Dynamic range of pulse output, 30 db.

(g) Steady state non-pulsed signal, automatically pulsed signal or a hand-keyed output pulse available by the operation of suitable switches.

(h) A visual signal indicating when a pulse is initiated.

Operating Principle

A block diagram of the circuit components employed in the pulser appears in Fig. 1. Voltage waveforms, and times of occurrence, observed in various portions of the system are indicated above the components.

A gas-tube R-C sawtooth oscillator is used as the rate control. The oscillator output is differentiated and the resulting negative voltage pulses are used to trigger a delay multivibrator and to provide synchronizing pulses for oscilloscope sweep synchronization.

The delay multivibrator remains fired for the interval of time t_1 to t_2 . The differentiated output consists of a positive pip at time t_1

and a negative pip at time t_2 as shown. The negative pip triggers the length multivibrator at time t_2 and this remains fired for the time interval t_2 to t_3 .

The rectangular, positive output pulse from the length multivibrator is impressed through a d-c restorer to the suppressor grids of the switch tubes. The restorer provides a suitable cutoff bias for the switch tubes except during the interval t_2 to t_3 , when the switch

be obtained as in position 1. The output of the switch tubes is added to this in the mixer amplifier. An auxiliary control regulates the maximum amplitude of the switch-tube output. By means of the two controls, any desired relative level of pulsed and non-pulsed signals may be obtained.

In position 3, a hand key may be used to turn the output on and off.

The schematic diagram of the pulser appears in Fig. 2. The gas-

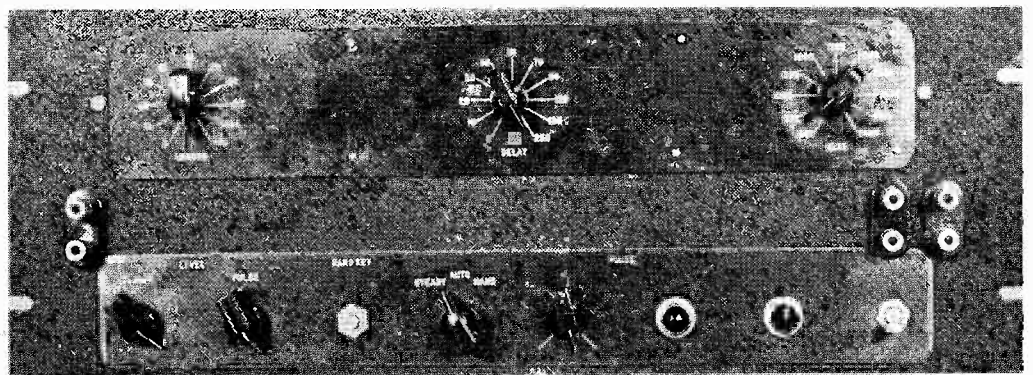

FIG. 3—Front view of laboratory model

tubes are rendered conducting by the positive length-multivibrator pulse.

The switch circuit has been described elsewhere². This circuit has a useful dynamic range of about 30 db and has negligible switching transient output over the range of signal levels employed.

The signal input may be connected for steady, automatic, or hand-key operation by means of a selector switch. With this switch in position 1 the input signal is applied directly through the level potentiometer and the mixer amplifier to the grid of the output cathode follower. This position is incorporated for convenience in observing the non-switched input signal and, in effect, shorts out the electronic switch.

With the selector switch in position 2, a non-switched output of any level from zero to maximum may

be obtained as in position 1. The output of the switch tubes is added to this in the mixer amplifier. An auxiliary control regulates the maximum amplitude of the switch-tube output. By means of the two controls, any desired relative level of pulsed and non-pulsed signals may be obtained. In position 3, a hand key may be used to turn the output on and off. The schematic diagram of the pulser appears in Fig. 2. The gas-tube R-C sawtooth oscillator comprised of V_1 , C_1 , and R_1 plus the attenuator will be noted in the upper left of the figure. In operation, C_1 charges through R_1 and the attenuator until the drop across C_1 reaches the ignition voltage of V_1 . Tube V_1 then fires and discharges C_1 through protective resistor R_2 until the extinction voltage of V_1 is attained, after which the above cycle is repeated. The repetition rate is determined by the calibrated attenuator and the intermediate control R_3 .

The discharge time constant of R_2C_1 , is very much smaller than the charge time constant so that a sawtooth oscillator output voltage is obtained. This is differentiated by C_2 and R_3 and the resulting negative voltage pip is used to trigger the delay multivibrator V_{2a} and V_{2b} . The length of the positive delay multivibrator output pulse appear-

ing at the plate of V_{2a} is controlled by the associated capacitor switching system. The front edge of this pulse occurs at the instant V_1 fires and is used for synchronizing.

The delay multivibrator output is differentiated by C_3 and R_1 and the negative voltage pip resulting at the end of the pulse is used to trigger the length multivibrator V_{3a} and V_{3b} . The length of the positive length multivibrator output pulse appearing at the plate of V_{3a} is controlled by the associated capacitor switching system.

It is evident from the above that the repetition rate, delay, and length of pulses are all independently adjustable.

The switching pulses from the length multivibrator are impressed on the suppressor grids of the switch tubes V_5 and V_6 through C_1 and R_5 . The output side of C_1 is connected to ground through V_6 , which acts as a d-c restorer or charging rectifier. By this means, the suppressors are maintained at a sufficient average negative potential with respect to ground as to cut off the switch tubes except during the pulse intervals.

The operation of the switch tubes is described in detail elsewhere². The signal to be pulsed is impressed on the grid of V_4 . The output pulses appear at the plate of this tube and are impressed across R_6 through C_5 . Resistor R_7 is an adjustable type which is used in initially adjusting the switch for minimum, no-signal, switching transient output.

The operation of the selector switch was described under the discussion of the block diagram. Tubes V_{7a} and V_{7b} are the mixer tubes previously mentioned, and V_8 is the

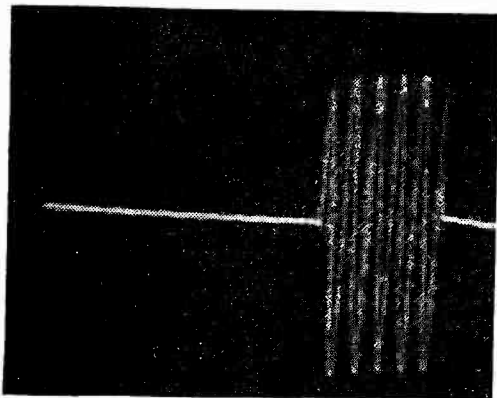

FIG. 4—Pulsed 1-kc signal, showing 10-millisecond delay from the start of the sweep at the left and 5-millisecond pulse length

output cathode follower. A VR-stabilized power supply, details of the attenuator, and the capacitor switching system complete the diagram.

Construction and Alignment

A front view photograph of the laboratory model appears in Fig. 3. Synchronization pips are obtained at the terminals at the left, while the two pairs of terminals at the right are signal input and signal output connections.

At the upper portion of the panel will be noted, reading from left to right, the pulse length control, the pulse delay control (the delay being measured in time from the time of occurrence of the synchronization pip), and the pulse rate control. The calibration of all of these controls is in milliseconds.

Near the bottom of the panel, reading from left to right, will be noted the two level controls; steady, R_8 , and pulse, R_9 . To the right of these controls is the hand key. This is a normally open pushbutton switch. The steady, auto, hand switch is the selector switch of Fig. 1, and provides pulser operation as previously described. The knob to the right of the selector switch is the intermediate value pulse rate control, R_1 . The rate oscillator tube V_1 is mounted behind the dial light to the right of the knob. This provides a visual check as to the instant at which this tube fires and, consequently, a check as to the instant at which the synchronizing pip occurs.

All other controls are screw-driver adjustments which are mounted on the rear of the chassis.

In the alignment process the device is first turned on and allowed to warm up. The vertical plates of an oscilloscope are connected to the sync output terminals and the delay multivibrator control, R_8 , is adjusted until rectangular output pulses are observed on the oscilloscope for all positions of the rate and delay control settings. In addition, it should be noted that the flashing of V_1 occurs simultaneously with the synchronizing pulses. The oscilloscope is then connected to the output terminals and the length multivibrator control R_{10} is adjusted so that symmetrical output pips are

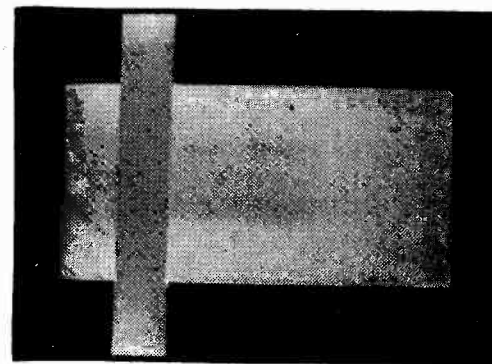

FIG. 5—Pulse superimposed on a 100-kc steady state signal

obtained for all combinations of rate, delay, and length settings.

After the multivibrators have been adjusted, the switching transient control R_7 in the plate of V_5 is adjusted for minimum no signal output with an oscilloscope connected to the output terminals.

Waveforms that should be obtained for each of these adjustments are indicated on the block diagram.

Figure 4 and Fig. 5 are photographs of the test results obtained with the device. In Fig. 4 a 1-kc oscillator was connected to the input of the pulser. The pulse length control was set at 5 milliseconds and the pulse delay control at 10 milliseconds. It will be noted that 5 cycles of the 1-kc signal appear within the pulse envelope as should be the case for this pulse length and signal frequency. The length of the delay is indicated by the length of the trace in front of the pulse. The clean edge at the beginning and conclusion of the pulse should be noted. This is due, in great part, to the transientless switch incorporated in the device.

Figure 5 is a photograph of the results obtained with a 100-kc oscillator connected to the input terminals of the pulser. For this case, the background level control was adjusted so that the pulses observed appear superimposed on a normal steady signal. This mode of operation is very useful in determining the response of high-gain amplifiers, incorporating avc controlled by the average signal, to pulse signals.

REFERENCES

- (1) Scheuch, D. R., and Cowan, F. P., Laboratory Pulse Generator With Variable Time Delay, *Rev. Sci. Inst.*, p 223, June 1946.
- (2) Butz, Jr., A. N., Surgeless Volume Expander, *ELECTRONICS*, p 140, Sept. 1946.

A Q of about 15 at 80 cps is obtained in this electronic filter by using selective feedback across the amplifier. Subminiature 6K4's are used to take full advantage of the saving in space made possible by the R-C network over an L-C type

By **JACK L. BOWERS**

*Radio and Electrical Laboratory
Consolidated Vultee Aircraft Corp.
San Diego, California*

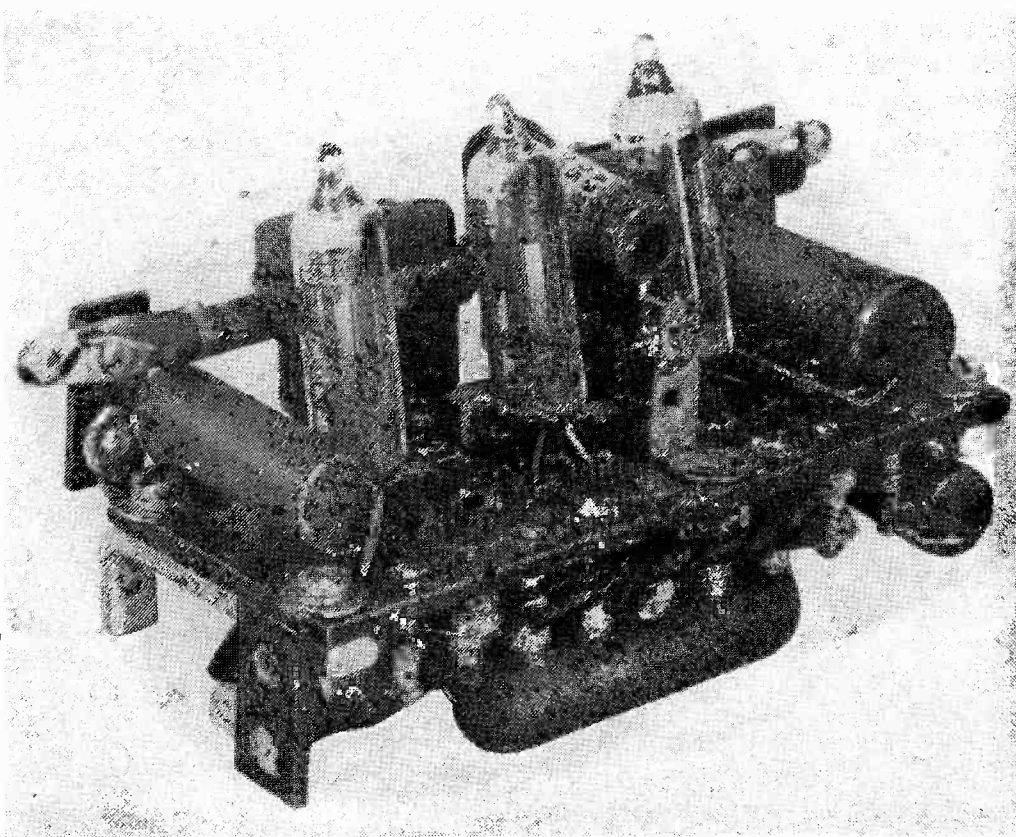

R-C

BANDPASS

Filter Design

Relationships between circuit parameters of a parallel-T R-C network, used as the feedback loop in an amplifier that gives the narrow bandpass characteristics of an L-C circuit, are determined. Design curves and applications to low-frequency filters are presented

AN ELECTRONIC FILTER with narrow bandpass characteristics can be made using the R-C parallel-T network in a feedback amplifier. By choice of component values different from those that produce the usual null characteristics, the bandpass characteristics obtained with this circuit are more desirable for many applications than those produced by the usual L-C filter.

Selective Negative Feedback

Considerable interest has been shown in the application of resistance-capacitance parallel-T networks for feedback in vacuum tube

amplifiers. The arrangement was first presented by H. H. Scott¹ for use as a selective circuit and more recently A. E. Hastings² has offered an excellent theoretical analysis. However, most of the effort in this field has been toward the use of the parallel-T network with parameters chosen to produce an absolute null at the operating frequency. The purpose of this paper is to describe the excellent practical results achieved using the circuit in a selective frequency filter under different operating conditions.

As commonly used, with the circuit designed to produce a complete

null, the output of the network can be used as a source of degenerative feedback voltage for all frequencies except that at which null occurs. Transfer characteristics so produced are sharply selective forming a cusp shaped curve at the desired frequency. Though this shape is excellent for selected applications such as wave analyzers, engineers find that most needs demand the ordinary L-C type of resonance curve of broader top and steeper sides. Less stability is then required of all frequency determining circuits and yet adequate attenuation is realized at short distances

from the selected frequency. As will be shown, this type of operation can be obtained from parallel-T networks when the circuit parameters are chosen properly.

Circuit Analysis

It will first be advisable to review the equations which describe the operation of the parallel-T network and establish design constants. For simplification, in the circuit shown as Fig. 1, the series resistances will be considered equal, as will the series capacitances. The shunt impedances will bear relations to be proven, that produce the frequency characteristics described in this paper.

The following four circuit equations can now be written substituting βE_1 for E_0 .

$$\begin{aligned} E_1 - I_1(R - jK/\omega C) + I_3(-jK/\omega C) &= 0 \\ E_1 + I_2(KR - j/\omega C) - I_3KR &= 0 \\ \beta E_1 + I_3(R - jK/\omega C) - I_1(-jK/\omega C) &= 0 \\ \beta E_1 + I_2KR - I_3(KR - j/\omega C) &= 0 \end{aligned}$$

If the determinant of the coefficients of the variables E_1 , I_1 , I_2 , and I_3 in the above four equations is set equal to zero and the resulting equation solved for β , the following relation obtained is the necessary condition to be met if the variables are to have values other than zero

$$\beta = \left\{ KR^3 - (2K^2R/\omega^2C^2) + j[(K/\omega^3C^3) - (2K^2R^2/\omega C)] \right\} / \left\{ KR^3 - (2KR/\omega^2C^2) - (2K^2R^2/\omega^2C^2) - (R/\omega^2C^2) + j[(K/\omega^3C^3) - (2K^2R^2/\omega C) - (2KR/\omega C) - (R^2/\omega C)] \right\}$$

If R is set equal to $1/\omega C$, then

$$\beta = \left\{ (K - 2K^2) + j(K - 2K^2) \right\} / \left\{ (K - 2K - 2K^2 - 1) + j(K - 2K - 2K^2 - 1) \right\}$$

which reduces to

$$\beta = \frac{2K^2 - K}{2K^2 + K + 1}$$

This equation shows that at a frequency where $R = 1/\omega C$, β is real and has a magnitude dependent only on K . If $K = 0.5$, $\beta = 0$, and the circuit exhibits a complete null. It has been shown elsewhere that under these conditions the network produces an abrupt phase reversal, changing from 90 degrees to a value of 270 degrees at the null point. If K is less than 0.5 there is only a partial null, and network phase shift attains a value of 180 degrees as is shown by the real, negative value of β . Reversal from 90 degrees to 270 degrees occurs more gradually with K .

Figure 2A shows the resulting

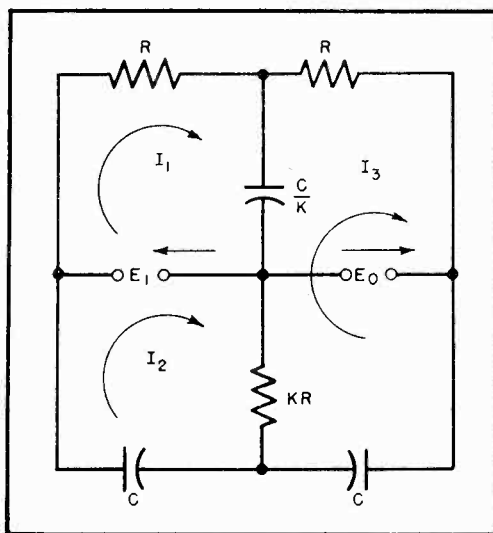

FIG. 1—Basic parallel-T R-C filter

effect of K on the network phase characteristic, and Fig. 2B indicates its effect on the attenuation vs frequency characteristic. Data for both sets of curves were obtained experimentally. Discrepancies which are evident in measurement of attenuation in Fig. 2B compared to the derived relation of β are attributed to experimental error and the finite resistance of capacitors used.

Filter Circuit

If the parallel-T network is used for a source of feedback in a vacuum tube amplifier, a small amount of regeneration will be obtained at the selected frequency when $K < 0.5$. At frequencies on either side, the magnitude of the feedback signal increases, but its phase is then approaching 90 or 270 degrees, and so the regenerative effect decreases. As the frequency moves farther from the center value, the phase becomes such that degeneration occurs and the amplifier produces a large degree of attenuation.

When gain of the amplifier is kept below the value which will produce oscillation due to regeneration at the center frequency, an excellent filter is obtained whose characteristic is similar to that of L-C circuits. Opposing effects of attenuation and phase characteristics at the center frequency produce a relatively broad topped curve, while its sides are steep. A filter circuit may be designed with values of effective Q up to 100 and at frequencies well

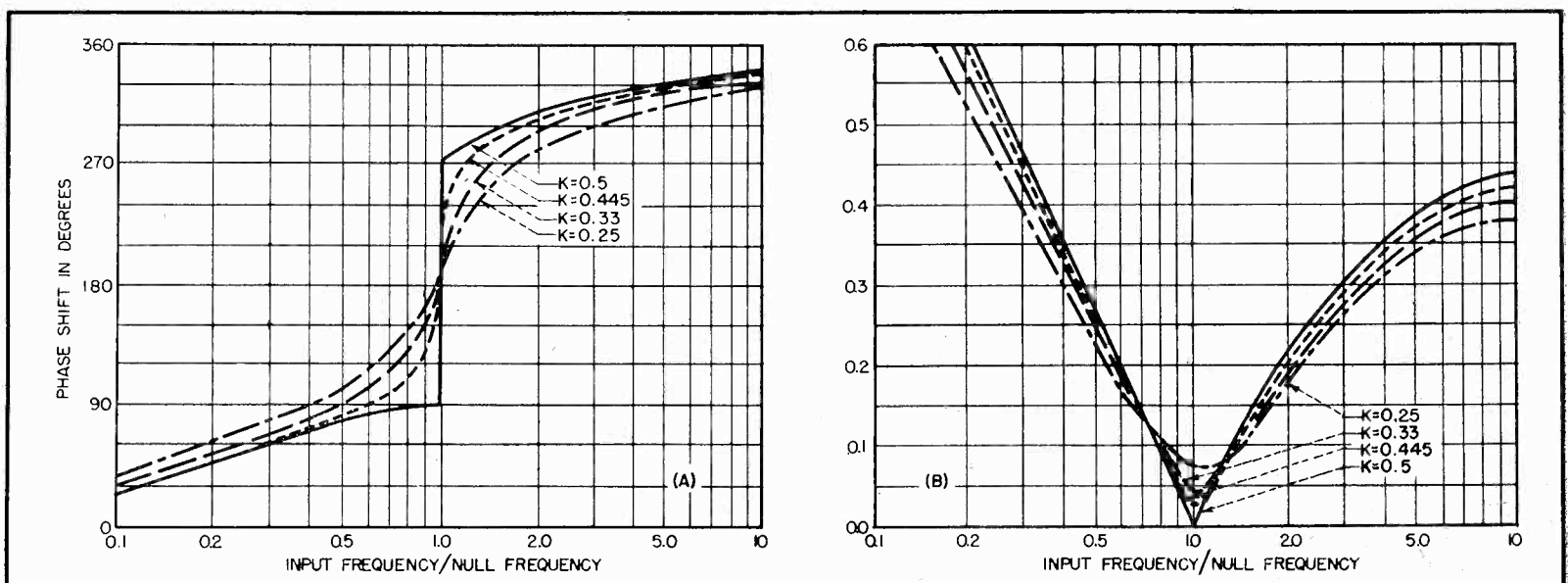

FIG. 2—By choice of the K the phase and amplitude characteristics of an R-C filter can be made similar to those of an L-C filter

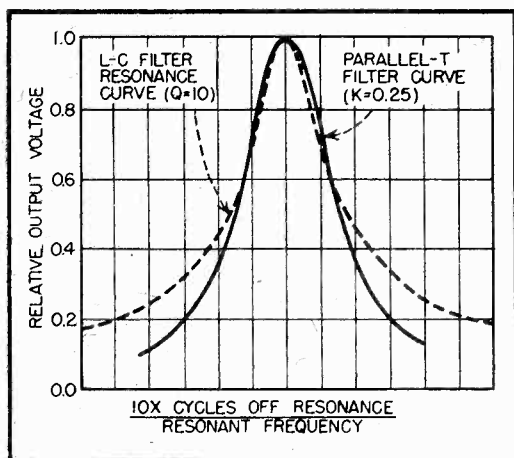

FIG. 3—Comparison of R-C and L-C filter characteristics

removed from the center the attenuation is greater than that of an L-C circuit. Typical filter characteristics are shown in Fig. 3.

Filter Amplifier Design

A filter amplifier can be designed from the formulas derived above. Sharpness of the selectivity will be proportional to the effective gain of the amplifier, so this is the first consideration. Depending upon whether a moderate or a very large Q is desired, a triode or a pentode amplifier will be chosen. For a high degree of stability, the amplifier may have three stages and employ a large amount of additional degenerative feedbacks which is not a function of frequency.

After design of the amplifier and calculation of its gain A a value of K will be chosen that gives a network transmission β substantially less than $1/A$, so that oscillation or instability is avoided. This value of K can be determined from the graph of Fig. 4. Upon examination of the curve, it may be seen that β increases in value until a maximum is reached at $K = 0.207$. At this point β has a value of 0.0934, which is the largest practical value for filter amplifier design. The circuit resistances and capacitances are then chosen according to the desired frequency $f_0 = 1/2\pi RC$. Further adjustment of the selectivity can then be made by varying the amplifier gain, or by changing the value of K , which involves the simultaneous change of the two shunt arms KR and C/K . If only one of the shunt arms is changed, there will be an accompanying change in frequency as well as selectivity.

A typical pentode amplifier cir-

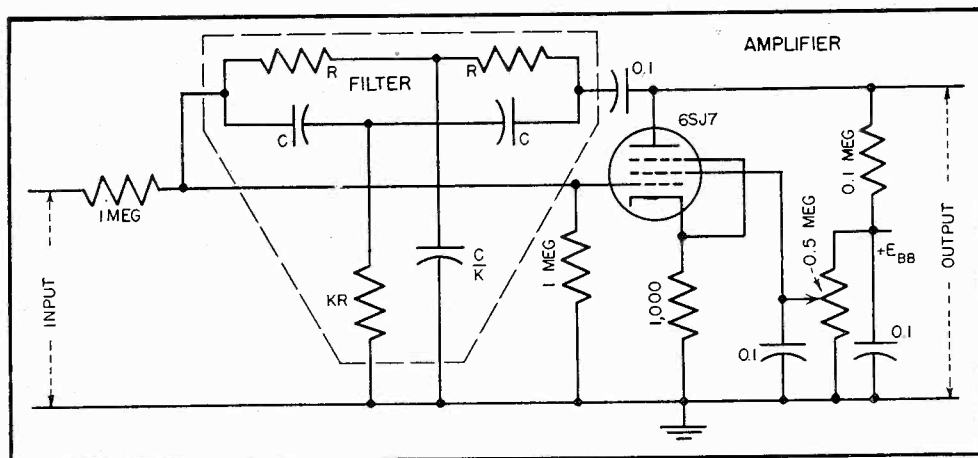

FIG. 5—Typical low-frequency electronic filter is amplifier with R-C network for feedback

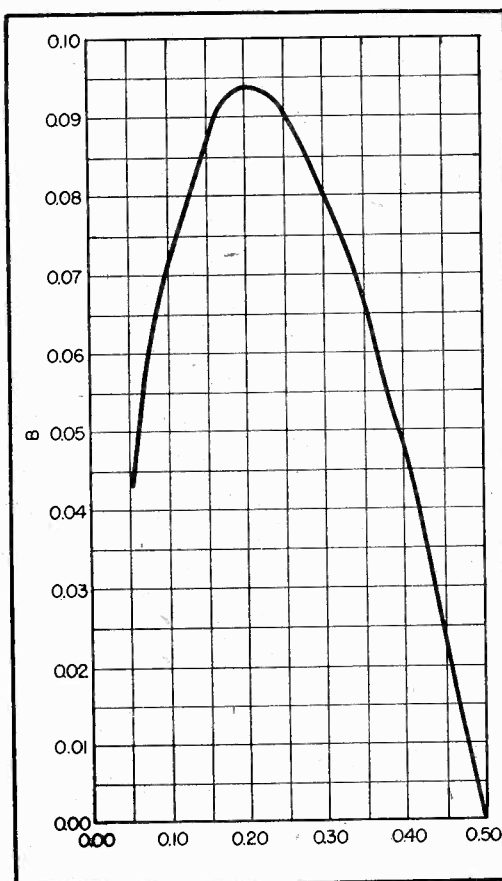

FIG. 4—Feedback as a function of filter selectivity (abscissa is K)

cuit with parallel-T feedback appears in Fig. 5. For f_0 of 60 cps with R of 265,000 ohms, C of 0.01 μf , and a K of $1/3$, Q was between 2 and 20 depending on the amplifier gain controlled by the screen potential. Such a filter would present very difficult design problems with L and C components and would be very large and heavy. A particular design problem of this type of filter is that of maintaining zero phase shift in the amplifier at its low operating frequency. This condition is obviously necessary, because it is the phase characteristic of the network that controls filter operation. A d-c amplifier would most efficiently solve this problem

by eliminating all low-frequency phase shift and removing the need for bulky coupling capacitors.

Advantages of Filter

A filter designed in this manner has advantages of small circuit components at all frequencies and a very desirable selectivity characteristic. Because only resistive and capacitive components are required, the problem of temperature compensation is relatively simple and moisture has little effect. Due to these features, this circuit is vastly superior to an L-C filter at audio and low ultrasonic frequencies. At higher frequencies, it will operate equally well, but the L-C networks begin to show their advantages. Compared to other types of R-C filters, the circuit described in this paper has definite advantages in circuits demanding a selectivity of relatively broad peak and steep sides. Also, consideration of attenuation and phase characteristics shows that with an amplifier of fixed gain, a higher amplitude ratio of passed to rejected frequencies is obtained, because degeneration is about the same in either case, while the parallel-T filter supplies additional gain due to regeneration at the passed frequency.

The author acknowledges research done by Kenneth Jenkins of Oakland, California, who upon the author's suggestion carried out work which culminated in the development of the subject circuit.

REFERENCES

- (1) Scott, H. H., A New Type of Selective Circuit and Some Applications, *Proc IRE*, p 226 Feb. 1938.
- (2) Hastings, A. E., Analysis of Resistance-Capacitance Parallel T Network and Applications, *Proc IRE*, p 126P March 1946.

SHF Heterodyne

Description of a portable instrument that can be used in the range 450 to 10,000 mc with a maximum error not exceeding 0.05 percent. The butterfly oscillator is checked at 5-mc points with a crystal that allows use of the equipment as a frequency standard accurate to 0.001 percent

THE heterodyne frequency meter to be described was developed primarily for use in the range 2,000 to 10,000 mc. It has, however, a useful range of 450 to 10,000 mc, the fundamental range of the heterodyne oscillator being 450 to 900 mc.

The incorporation of a crystal calibrating circuit makes possible frequency measurements with a maximum overall error of ± 0.05 percent; the heterodyne oscillator may be finely tuned by a gear reduction system, allowing measurements of frequency modulation and frequency increments of 0.01 percent. The instrument illustrated stands 12 inches high, 18 inches long, 6 inches deep, and is conveniently portable for laboratory use.

Measurement Methods

Frequency in the range 2,000 to 10,000 mc is commonly measured with tunable resonators, or wave-meters, of several types: coaxial-line, cylindrical-cavity, or transition. These devices may be used as transmission or absorption elements. They are relatively small, light-weight, and simple.

The instrument described in this paper is considerably more complex than the devices named above, but it has greater utility, greater sensitivity, is self-calibrating, and op-

erates over a wide frequency range. It can also be used as a low-power-level frequency standard of ± 0.001 percent accuracy.

The block diagram of the heterodyne frequency meter shown in Fig. 1 illustrates the components of the instrument and their function.

The unknown frequency F_1 in the range 450 to 10,000 mc is coupled into mixer no. 1, which is also coupled to the heterodyne oscillator. This oscillator has a calibrated dial and its frequency F_2 can be continuously varied between 450 and 900 mc. Thus F_1 may be measured by the usual heterodyne method; a series of values of F_2 is observed for which an audio beat note with F_1 is heard in the phones connected to amplifier no. 1.

In general, audio beats are heard if $nF_2 = mF_1$, where $n = 1, 2, 3, \dots$, and $m = 1, 2, 3, \dots$. In this case the audio beat notes are loudest when $m = 1$. If F_2' and F_2'' are values of F_2 for two adjacent values of n , and if $m = 1$, then

$$nF_2' = F_1 \quad (1)$$

$$(n+1)F_2'' = F_1 \quad (1a)$$

and

$$F_1 = \frac{F_2' F_2''}{F_2' - F_2''} \quad (2)$$

If F_1 is known approximately, then n is known for a particular value of F_2 and it is only necessary to determine the value of F_2 in order to determine F_1 . It can be done in a single operation, thus making the measurement a simple one. The accuracy of measurement of F_1 is equal to the accuracy of determination of F_2 , which in this case is ± 0.5

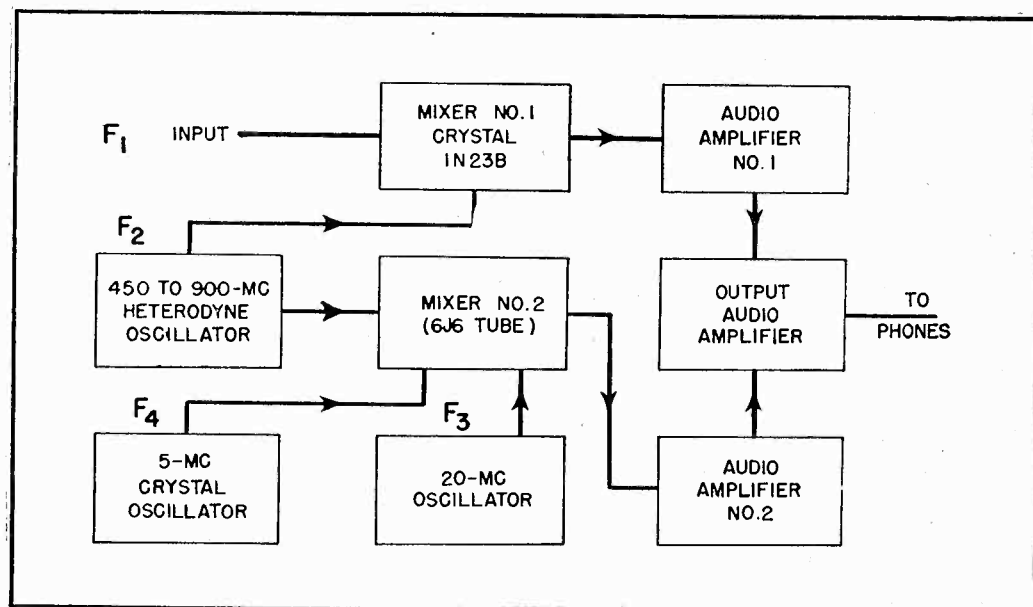

FIG. 1—Block diagram of the frequency meter. Gain controls allow the user to select the desired beats to be fed into the output audio amplifier

The work reported in this paper was done at the Radio Research Laboratory, Harvard University, under contract with Division 15 of the National Defense Research Committee.

Frequency Meter

By
CARSON D. JEFFRIES
*Stanford University
California*

percent—the normal dial calibration accuracy of the heterodyne oscillator.

Crystal Calibrator

In order to determine F_2 more accurately it is necessary that a special calibration circuit be employed. A crystal oscillator whose frequency F_1 is $5\text{ mc} \pm 0.001$ percent is used as a standard and coupled to mixer no. 2. Also coupled to this mixer is a 20-mc oscillator whose frequency F_3 may be slightly varied. The coupling between these two oscillators is sufficient to allow F_3 to be locked-in with $4F_1$ when they are adjusted to zero beat by means of the mixer, audio amplifier no. 2, and earphones. The heterodyne oscillator is also coupled to mixer no. 2, and as F_2 is varied, there will be heard in the phones audio beat notes every 5 mc in the range of the heterodyne oscillator. These check points are beats between F_2 and nF_1 , and accurate to within ± 0.001 percent. By linear interpolation between them F_2 may be determined at any point on the dial to within ± 0.05 percent.

Because the heterodyne oscillator dial calibration accuracy is only ± 0.5 percent, it is possible for 5-mc check point frequencies to be ambiguous over most of the range; such an impasse is avoided by turning off the crystal oscillator and first finding a reference point with only the 20-mc oscillator.

Separate audio channels and

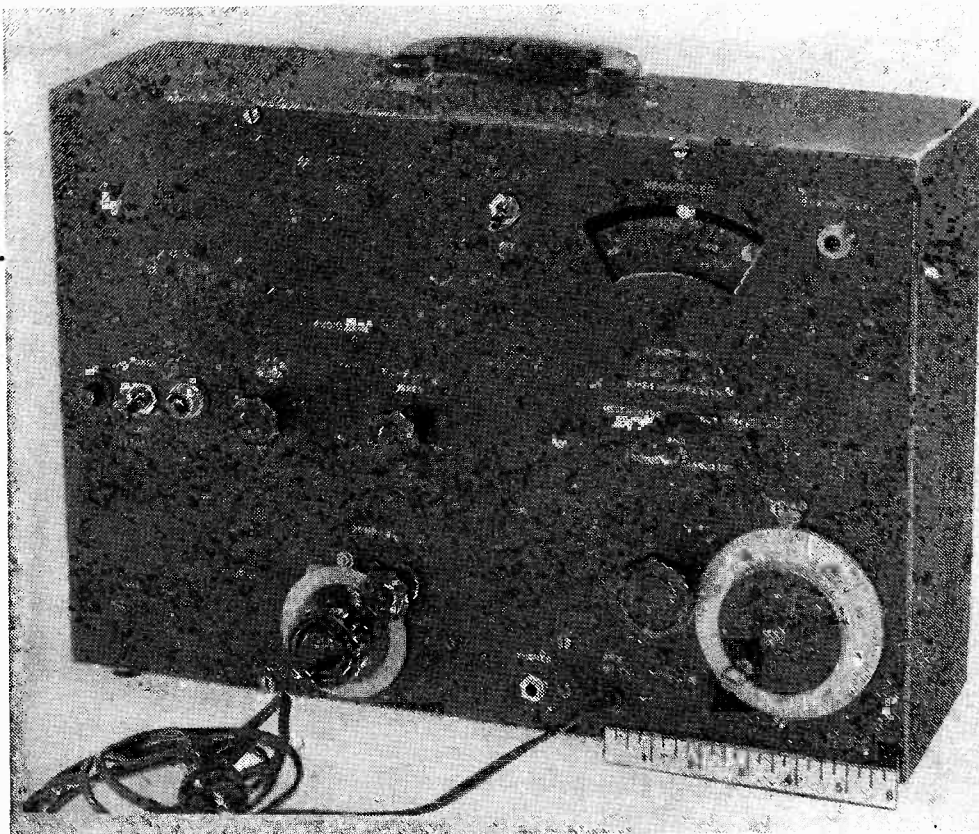

SHF heterodyne frequency meter and frequency standard

gain controls for the two mixers are used so that the instrument can be used without the calibration circuit for rapid measurements without high accuracy, and the dial calibration of F_2 may be quickly checked without hearing interfering beats with unknown frequencies. Adjacent check points and a beat with an unknown frequency can be identified separately and then heard together with minimum interpolation errors.

The instrument may be used as a frequency standard by setting F_2 to any of the 5-mc check points in its range. This will determine F_2 to an accuracy of ± 0.001 percent. Mixer no. 1 will generate harmonics of these standard frequencies up to 10,000 mc and these signals can be taken from the F_1 input connector.

The complete schematic diagram of the instrument aside from the conventional power supply, is shown in Fig. 2 and described below.

Circuit Description

The heterodyne oscillator and mixer no. 1 are mounted in an aluminum alloy casting fitted with a tight cover for r-f shielding. Figure 3 shows this unit with the cover removed. The oscillator is a type 6F4 triode tube operating in a butterfly circuit that combines mechanical simplicity with compactness and avoids sliding r-f contacts. The butterfly rings are 2 inches in diameter and there are three in the stator stack. The rotor is also a stack of three plates and has an insulated shaft and ball bearing support. The rotor requires 90 degrees

rotation to vary the frequency from 450 to 900 mc and is coupled to the panel tuning control by a 30-to-1 reduction worm gear; it is also connected through a 450-to-1 reduction to the panel fine tuning and interpolation dial control.

The frequency dial is $6\frac{1}{2}$ inches in diameter and is directly calibrated in terms of F_2 ; the interpolation dial is $4\frac{1}{2}$ inches in diameter and has 100 equal divisions and a hair line index. The whole mechanical system is spring loaded in order to eliminate backlash.

Frequency Stability

The oscillator has good mechanical and plate voltage stability. The plate, heater, and cathode chokes have been experimentally chosen to give smooth oscillator operation over its entire range. Incidental

frequency and amplitude modulation is very small, the check points being very pure beat notes over the entire range. Since there are no sliding contacts, no noise is evident as the oscillator is tuned.

Adequate r-f shielding of the oscillator is obtained by use of the cast housing and tight cover, L-C filters in all power leads entering the oscillator cavity, and additional shielding of the worm gear system. It is necessary to prevent leakage of r-f power in order to avoid a serious noise problem; many parts of the oscillator drive mechanism could be paths of random r-f current flow, giving rise to broad bands of noise to be picked up by the mixers and amplifiers.

Mixer no. 1 as illustrated consists of a type IN23B crystal coupled inductively to the heterodyne

oscillator and in series with the coaxial line input of F_1 , the unknown frequency. A d-c load resistance across which are developed audio beat frequencies is mounted outside of the casting.

The 5-mc crystal oscillator is of conventional electron-coupled design. It uses a 6AK5 miniature pentode and a 5-mc temperature-compensated quartz plate with a variable pressure plate that allows the frequency F_4 to be set against a primary or secondary frequency standard. This oscillator will maintain its accuracy to within ± 0.001 percent for normal (± 20 C) temperature variations. A panel switch cuts the plate supply on or off.

Secondary Calibrator

The 20 mc oscillator is a conventional Hartley circuit using a type

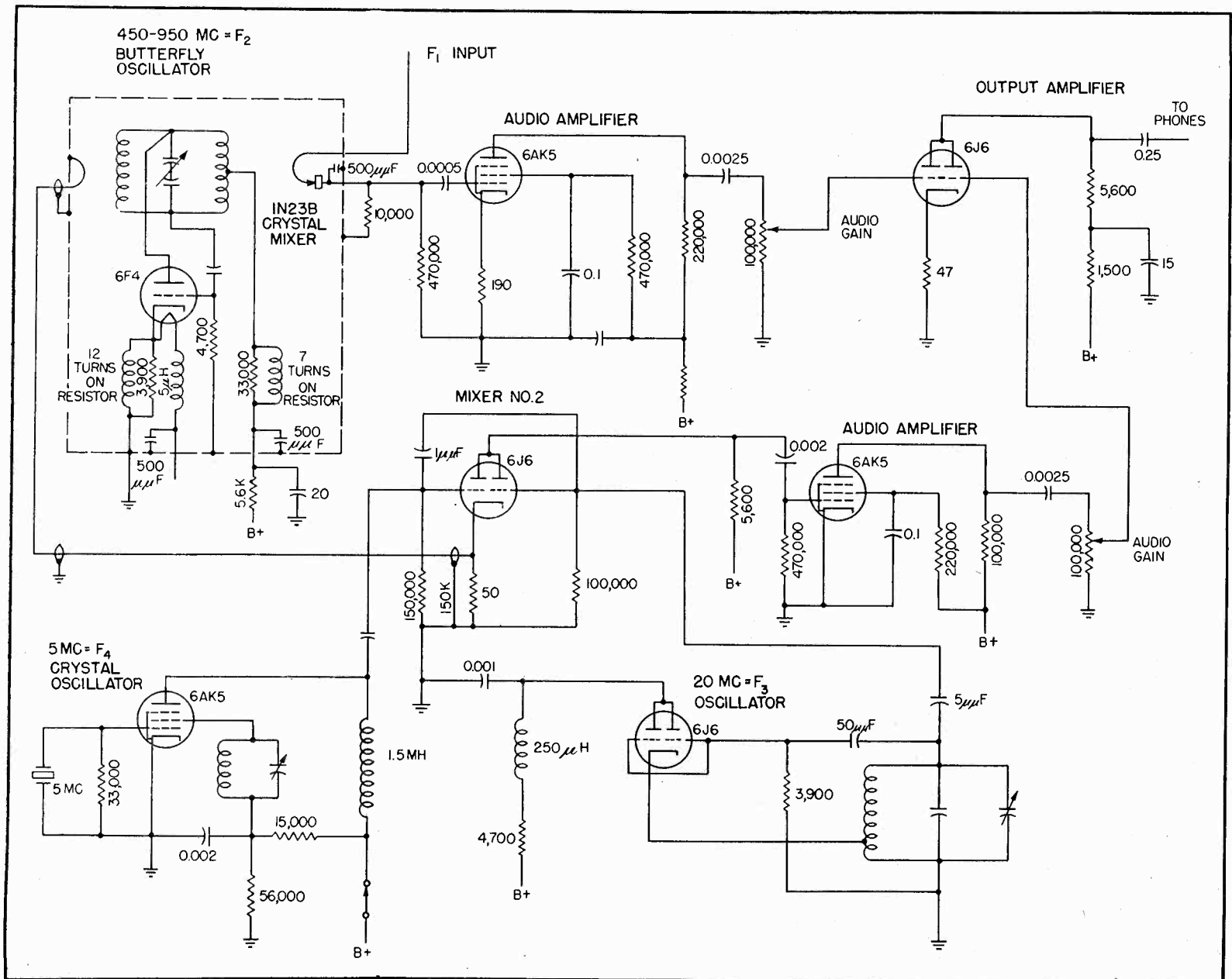

FIG. 2—Complete schematic diagram of the heterodyne frequency meter. The power supply, not shown, has two outputs suitably isolated to prevent coupling between units of the equipment

6J6 miniature dual triode with the elements connected in parallel. It is slightly tunable by means of a panel trimmer control.

Mixer no. 2 is a type 6J6 miniature dual triode using each grid and the cathode as three separate inputs. The crystal oscillator and the 20 mc oscillator are each capacitively coupled to a grid and to each other. The heterodyne oscillator is coupled in by means of a loop in the cavity feeding a 50-ohm coaxial line terminated in a 50-ohm disc resistor that is also the cathode resistor of the 6J6 tube. This connection gives low impedance coupling and prevents reaction on the heterodyne oscillator.

Audio amplifiers no. 1 and no. 2 are each conventional resistance-capacitance coupled 6AK5 pentode amplifiers with separate gain controls on the panel. They each feed into separate grids of the 6J6 output audio amplifier to which high impedance earphones are capacitively coupled.

The power supply is quite conventional, with resistance-capacitance filters used to decouple various components. The method of decoupling has not been indicated in the diagram, all leads to the plate power supply being marked B+.

Limitations to Accuracy

It has been stated that the maximum overall measurement error of this heterodyne frequency meter is ± 0.05 percent, and this can be simply proved. The accuracy of measurement is the accuracy of determination of F_2 . Points of ± 0.001 percent accuracy are placed on the F_2 dial every 5 mc by the calibration circuit. Linear interpolation must be used to determine F_2 between these points. The tuning curve of F_2 is not truly linear, the deviation from linearity in the vicinity of 450 mc being -0.03 percent of frequency at the midpoint between two adjacent check points; at 750 mc the deviation is 0.0 percent; at 900 mc it is $+0.02$ percent. Any backlash errors can be eliminated by proper technique. The interpolation dial can be accurately read only to about $\frac{1}{3}$ of a

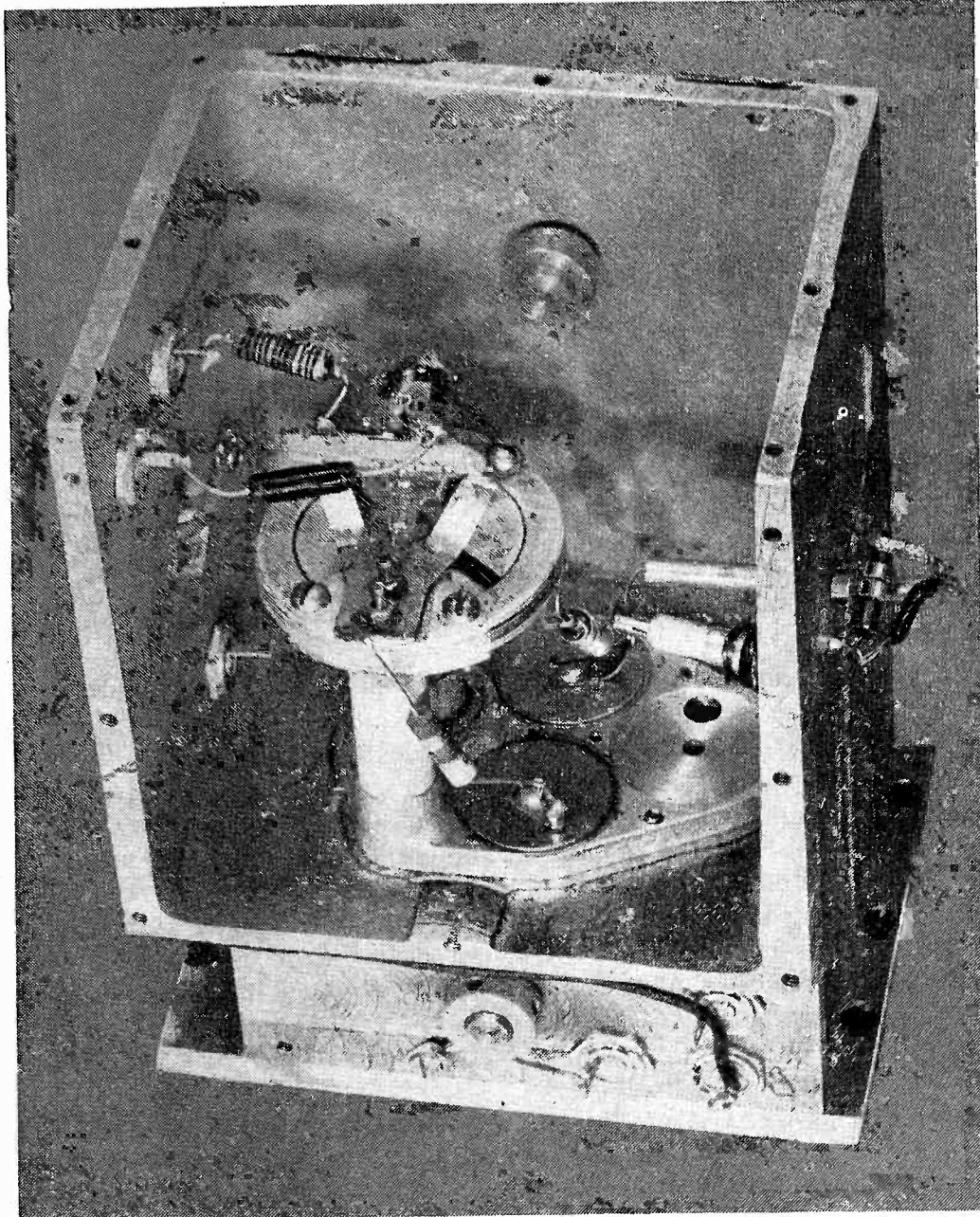

FIG. 3—Detail of the 450 to 900-megacycle butterfly oscillator. Cathode and plate chokes are wound on resistor bodies. The coupling loop and crystal at the right are represented by mixer No. 1 in the block diagram, while the load resistor for the circuit is just outside the cast housing

division, thus causing an error of about ± 0.01 percent of frequency. Thus the total error arrived at by adding ± 0.03 percent for dial non-linearity, plus ± 0.01 percent for interpolation dial errors, plus ± 0.01 percent for other errors gives ± 0.05 percent. Because of the improved F_2 dial linearity this total error is only ± 0.02 percent in the F_2 range of 650 to 800 mc.

By improving the dial linearity of the heterodyne oscillator and by using more closely spaced check points, it is possible to construct a frequency meter similar to this one with an error of measurement of 1 part in 10^5 .

No adequate measurements of the sensitivity of this instrument have been made; it varies widely over the range and is of the order of 0.01 microwatts at 200 mc and 10 microwatts at 10,000 mc.

Acknowledgment

The author wishes to acknowledge the helpful suggestions of H. E. Overacker, A. P. G. Petersen, and W. B. Wholey.

REFERENCES

- (1) Karplus, Eduard, Wide Range Tuned Circuits and Oscillators for High Frequencies, *Proc. IRE*, p 426, July 1945.
- (2) Essen, L., and Gordon-Smith, A.C., The Measurement of Frequency in the Range 100 mc to 10,000 mc, *Jour. IEE*, 92, p 291, 1945.

Wideband I-F Amplifiers

Advantages of high gain with wide bandwidth can be obtained from stagger-tuned coupling networks provided compensation is made for extraneous frequency-selective feedback through the tubes. Design considerations and procedure are presented

IMAGE REJECTION ratio¹ is one of the important performance characteristics in the development of wide-range tunable superheterodyne receivers for the uhf and shf regions (300 to 30,000 megacycles). If a tunable receiver is to be a truly single-dial, single-signal receiver, all spurious responses, the most important of which is the image response, must be reduced to below the level where objectionable interference may be encountered.

Two major components of a system which introduces attenuation to the image response are (1) an r-f preselector and (2) an i-f amplifier which removes the image frequency sufficiently far from the desired signal frequency that advantage can be taken of the selectivity of the r-f preselector.

To determine the image rejection obtained with a given intermediate frequency, one simply determines the ratio of the response in the r-f passband to the response at two times the intermediate frequency from the passband. Increased rejection is obtained with higher i-f.

Design Parameters

Information required by a designer of an i-f amplifier is (1) frequency, (2) bandwidth, (3) gain, (4) off-band rejection. The frequency is obtained by joint agreement between preselector and amplifier designers. In receivers under consideration, a minimum image rejection ratio of at least 60 db is desired. A family of curves which aid in the selection of the required number of preselector circuits and intermediate frequency is shown in Fig. 1². Curves are for maximum insertion loss in the r-f passband of three db (L_0) and give the insertion

By
MATTHEW T. LEBENBAUM

*Airborne Instrument Labs., Inc.
Mineola, N. Y.*

loss of the filter at any frequency f outside the center of passband f_0 .

For example, if a 70-db image rejection ratio is required, and for design considerations of tracking and oscillator stability the r-f bandwidth is 50 mc, it can be seen from Fig. 1 for $n = 1$ that a single-tuned preselector will be unsatisfactory regardless of intermediate frequency. If two tuned circuits ($n = 2$) are used, the parameter $x = (f - f_0)/\Delta f$ is taken from the curve to be equal to 20 for 70-db rejection. Because $\Delta f = 50$ mc and $f - f_0 = 2f_{i-t}$, then $f_{i-t} = 20 \times 50/2 = 500$ mc. For three tuned circuits ($n = 3$) $f_{i-t} = 4.6 \times 50/2 =$ approximately 120 mc.

Agreement must be reached on the relative complexities involved in the two alternatives. In the particular case to which the above figures refer, a three-cavity preselector, and an i-f amplifier, centered at 160 mc were chosen. Bandwidth is generally dictated by the intelligence to be received. In this case, 20 mc was used.

The overall gain required is a function of the receiver application. For general monitoring of a portion of the radio-frequency spectrum, which was desired, reception of signals down to noise level is required. Sufficient gain must therefore be included to bring the receiver noise up to a level at which the second detector is operating linearly. Total gain is thus a function of the noise figure of the receiver. The 160-mc i-f amplifier used as an example in this article incorporated between 90 and 100-db voltage gain from input grid through the second detector.

Off-band rejection requirements are determined by the specific application, but in general, the requirement of high gain requires a large number of stages, and (as will be seen later) the circuits which must be used to obtain the combination of high gain and large bandwidth are such as to insure excellent skirt rejection.

Amplifiers Above 100 Mc

Design of amplifiers operating above 100 mc is one which is as much a mechanical problem as an electrical one, if lumped constant interstage networks are to be used.

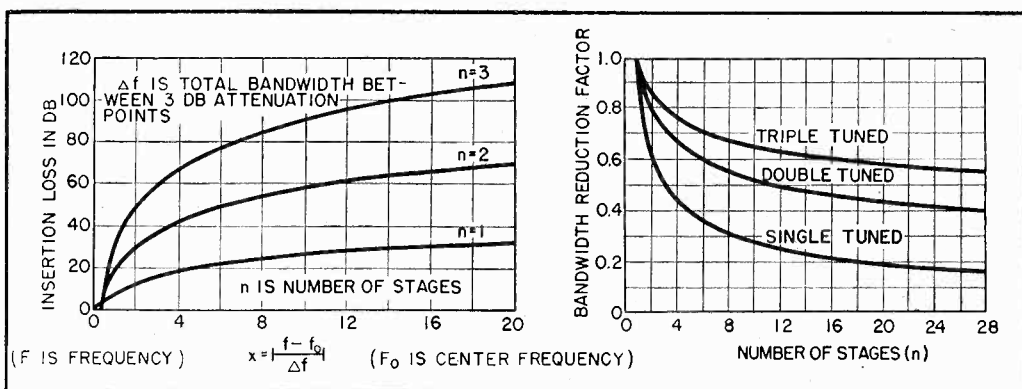
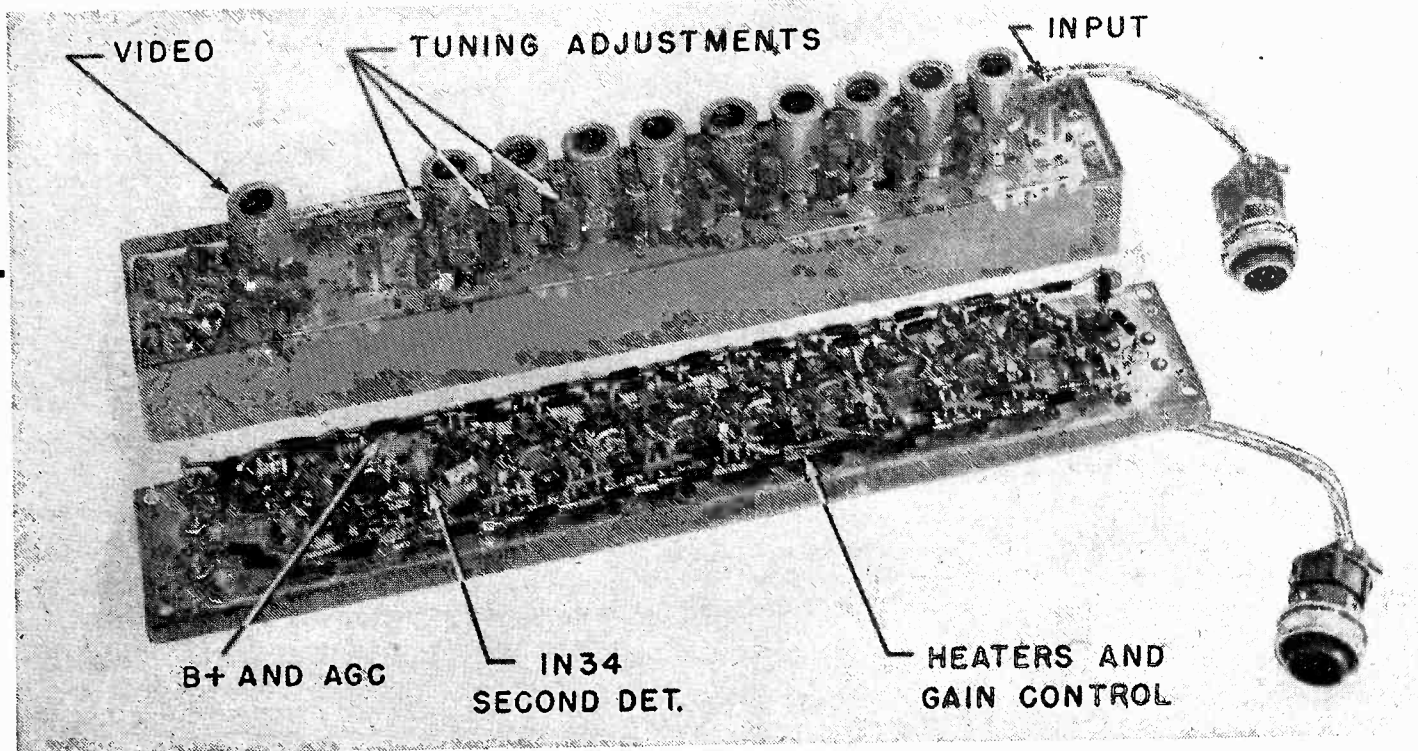

FIG. 1—Normalized curves for selecting number of preselector circuits for a specified skirt rejection

FIG. 2—Degree of narrowing of passband introduced by multiple couplings all tuned to the same center frequency

above 100 Mc



Construction of stagger-tuned i-f amplifier for 160 mc shows minimum of wiring and little interstage shielding

These networks must be kept compact with the fewest and shortest possible leads. If a design is used which deviates from these requirements, experience has shown that regeneration troubles invariably arise, and their elimination results in mechanical layouts which are cumbersome, difficult to build, and even harder to service. For the above reasons, a highly desirable type of coupling is the single-tuned network using tube and stray capacitances as shunt capacitance and a variable inductance for tuning. This network can be constructed in extremely small space with very short leads.

The disadvantage of this coupling is that the gain-bandwidth product³ of a single-tuned network is low compared to more complex networks, off-band rejection is also low, and overall bandwidth of a series of single-tuned stages becomes rapidly smaller as the number of stages is increased. Figure 2 shows the degree of narrowing as a function of the number of cascaded stages for single-tuned coupling as well as for double and triple tuning. There is a definite advantage in the use of more complex coupling networks, completely aside from the

fact that their gain-bandwidth products are higher to start with, because of less rapid narrowing with increasing number of stages, but unfortunately, these networks are difficult to realize at high frequencies.

If single-tuned circuits are used, it can be shown that if both high gain and large bandwidth are required, the resultant amplifier rapidly becomes uneconomical and under certain conditions impossible of construction. Figure 3 shows the number of stages required to realize given bandwidths and gains using cascaded single-tuned coupling. With gains of 100 db and bandwidths greater than 4 mc, the cascaded single-tuned amplifier is impractical.

Stagger-Tuned Circuits

To retain the simplicity of the single-tuned amplifier and to obtain the desirable gain-bandwidth product and slower narrowing of the overall bandwidth of multituned networks, stagger tuning is used. By properly adjusting tuning frequencies and damping of individual single-tuned stages, results approaching those obtainable with multituned coupling can be ob-

tained with little sacrifice of simplicity.

The theory of stagger tuning has been adequately covered in the literature⁴ so no derivations will be included in this paper. The method has proved to be exceedingly powerful in the simple solution of most present wideband, high-gain amplifier problems.

In discussing stagger tuning, it is convenient to express the gain-bandwidth product in units of $g_m/2\pi C_r$ and call this the gain-bandwidth factor. The gain-bandwidth factor for a single-tuned stage is, therefore, unity⁵.

A STAGGERED PAIR of overall bandwidth Δf and geometrically centered at f_0 consists of two single-tuned stages of dissipation factor $D = 1/Q$ and tuned at frequencies $f_0\alpha$ and f_0/α respectively. Where δ is less than 0.3

$$\begin{aligned} D &= 0.707\delta \\ \alpha &= 1 \pm 0.333\delta \\ \delta &= \Delta f/f_0 \end{aligned}$$

The stage gain times overall bandwidth factor of this combination will be unity. Figure 2 shows that the corresponding factor for two cascaded stages is only 0.64. In addition, overall selectivity function of the staggered pair will be, in

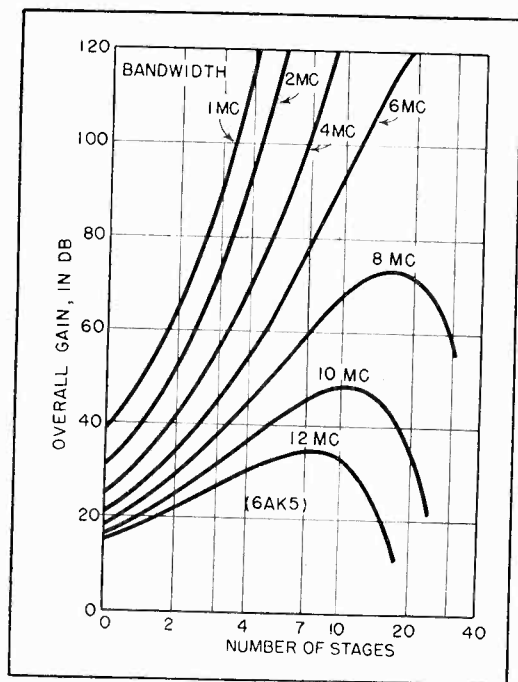

FIG. 3—Curves relate the three functions total gain, bandwidth, and number of stages for cascaded single-tuned couplings

both absolute value and phase, that of a transitionally-coupled⁶, double-tuned circuit. For this reason overall bandwidth decreases more slowly as staggered pairs are cascaded than for identically tuned stages. Figure 2 gives the narrowing factor for staggered pairs and triples by using the double-tuned and triple-tuned curves respectively where n is the number of pairs or triples.

A STAGGERED TRIPLE of overall bandwidth Δf and geometrically centered at f_0 consists of two single-tuned stages of dissipation factor D staggered at $f_0\alpha$ and f_0/α and one single-tuned stage of dissipation factor δ centered at f_0 . Where δ is less than 0.3

$$\begin{aligned} D &= 0.5\delta \\ \alpha &= 1 + 0.433\delta \\ \delta &= \Delta f/f_0 \end{aligned}$$

The stage gain times overall bandwidth factor of this combination will be unity, and the overall selectivity function will be, in both absolute value and phase, that of a transitionally-coupled triple-tuned circuit. Three cascaded single-tuned circuits would give a corresponding factor of only 0.54. It is also seen that the overall bandwidth decreases even more slowly as triples are cascaded.

It is possible to carry the staggering to n stages, but in the practical case the pair or triple is normally used and if more gain is required than can be obtained in this

manner additional pairs or triples are used in cascade.

Calculating Circuit Values

As an example of the design of an amplifier, the following requirements are set: $f_0 = 160$ mc, overall bandwidth $\Delta f_A = 20$ mc, overall gain $G_A = 100$ db. As a first approximation, assume four triples are required. From Fig. 2, each triple must be $\Delta f_T = \Delta f_A/0.76 = 20/0.76 = 26.3$ mc wide. For 6AK5's, $g_m = 5,200$ μ mohs, $C_T = 11$ μ mf, so that the stage gain (G_S) times the bandwidth per triple (Δf_T) is

$$\begin{aligned} G_S \Delta f_T &= g_m/2\pi C_T \\ &= \frac{5,200 \times 10^{-6}}{2\pi 11 \times 10^{-12}} = 75 \times 10^6 \end{aligned}$$

and the stage gain is $75 \times 10^6/26.3 \times 10^6 = 2.86$ or 9.1 db, and overall gain (for four sets of triples giving 12 stages) is $9.1 \times 12 = 109$ db.

$$\begin{aligned} \delta &= \Delta f_T/f_0 = 26.3/160 = 0.158 \\ f_1 &= f_0\alpha = f_0(1 + 0.433\delta) \\ &= 160(1 + 0.433 \times 0.158) = 170.9 \text{ mc} \\ f_2 &= f_0/\alpha = f_0/(1 + 0.433\delta) \\ &= 160/(1 + 0.433 \times 0.158) = 150 \text{ mc} \\ f_3 &= f_0 = 160 \text{ mc} \\ D &= 1/Q = 0.5\delta = 0.5 \times 0.158 = 0.079 \\ Q_1 &= Q_2 = Q = 1/0.079 = 12.7 \\ Q_3 &= 1/\delta = 1/0.158 = 6.33 \\ R_1 &= Q_1/2\pi f_1 C_T \\ &= \frac{12.7}{2\pi 170.9 \times 11 \times 10^{-6}} = 1,060 \text{ ohms} \\ R_2 &= Q_2/2\pi f_2 C_T \\ &= \frac{12.7}{2\pi 150 \times 11 \times 10^{-6}} = 1,210 \text{ ohms} \\ R_3 &= Q_3/2\pi f_3 C_T \\ &= \frac{6.33}{2\pi 160 \times 11 \times 10^{-6}} = 560 \text{ ohms} \end{aligned}$$

The parameters of the amplifier

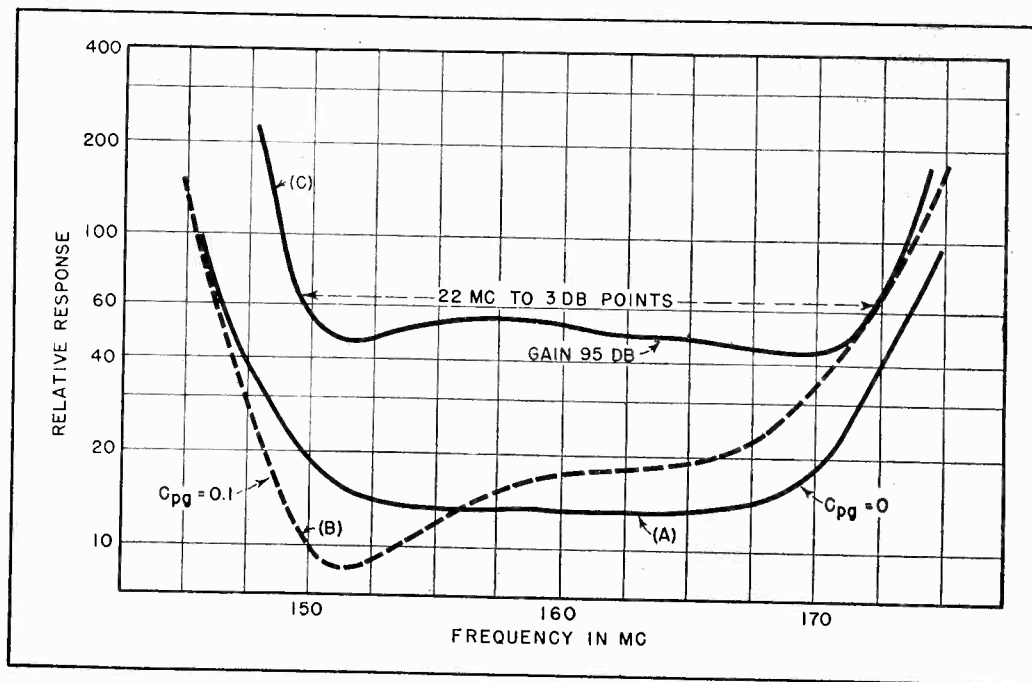

FIG. 4—Because of selective loading from feedback within the tube, the response (A) of a nine-stage amplifier of three triples was distorted (B) Response curve (C) of the amplifier after readjustment of staggered frequencies and damping

are thus determined. (A staggered pair would be designed similarly by using the constants previously presented for it.) The selectivity of the tuned circuits must be realized, thus the calculated resistances must be changed to take into account the tube's input conductance and finite coil Q . In stagger-tuned amplifiers centered in the vicinity of 30 mc, it is customary to use damping resistors one five-percent RMA size higher than that calculated in order to compensate for losses external to the damping resistor.

Extraneous Damping

Unfortunately, at frequencies above 100 mc, the effect of the grid-plate capacitance becomes of increasing importance. The effect of this feedback path is to distort the selectivity curve, tilting it with greater gain at the low end of the band and less at the high. At frequencies below 100 mc, it is usually sufficient to compensate for conductive and susceptive components of feedback admittance by retuning the grid circuit to the proper frequency and readjusting the damping.

As the center frequency is raised, this type of correction becomes less effective. Figure 4 shows the calculated selectivity curves of an ideal amplifier using three triples to obtain a 20-mc bandwidth at 160 mc, and of the same amplifier with the

feedback included and with the individual stages retuned to the calculated stagger frequency and with the damping adjusted to the theoretical values. This calculation must be carried out stage by stage as the effect is cumulative. Feedback capacitance was assumed to be 0.1 μf , which is about twice the normal value in a 6AK5, and was chosen to magnify the effect. However, actual experimental results show this tilting to be of such magnitude as to require additional compensation.

If the values of tuning frequencies and loading are varied from the theoretical, the passband can no longer be maintained flat without great sacrifice in gain. However, if small dips and peaks are allowable, a good compromise can be obtained by designing the amplifier for a slightly wider band than required, about ten percent, and adjusting the damping empirically to obtain the optimum result. The new values of loading are difficult to calculate because of their dependence on the value of the grid-plate capacitance, which may vary from tube to tube and stage to stage by a considerable percentage. It can be shown that the feedback admittance has conductive and susceptive values of the form

$$G_f = B_{gp} \frac{g_m B_L}{G_L^2 + B_L^2}$$

$$B_f = B_{gp} \frac{1 + g_m G_L}{G_L^2 + B_L^2}$$

where G_f and B_f are the conductive and susceptive portions of the admittance of the grid circuit as the result of a grid-plate susceptance $B_{gp} = C_{gp}$. Also B_L and G_L are the conductive and susceptive portions of the plate load admittance. Because G_L must always be positive, it may be seen that the B_f is always positive (or capacitive). However, because B_L may take either sign, being negative below resonance of the plate circuit and positive above, the conductive component varies widely with frequency.

The effect is noted especially in the case of stagger tuning; if the grid circuit is tuned to a lower frequency than the plate circuit, grid-plate capacitive feedback produces a negative damping in the grid and when the grid is at a higher frequency, a positive damping. This loading changes with frequency and so the selectivity curve of the tuned

circuit is distorted. This distortion, when magnified by successive stages, produces the results shown in Fig. 4.

Compensation

As mentioned above, it is difficult to calculate correction factors because of the uncertainty of the value of C_{gp} . Despite the importance of feedback with conventional tubes above 100 mc, a good compromise can be obtained by empirical adjustments. Figure 4 shows the selectivity curve of the 160-mc amplifier whose design was discussed. The following table shows the effect of feedback and tube loadings on the values of the parameters

	Frequency	
	Calculated	Adjusted
High.....	170.9	172.5
Low.....	150	149
Center.....	160	160

	Resistance	
	Calculated	Adjusted
High.....	1,060	2,700
Low.....	1,210	820
Center.....	560	820

This amplifier had a gain, including loss in the second detector, of about 95 db which is quite close to the predicted gain, showing that the compromise was made with but little sacrifice.

An important achievement in the use of single-tuned circuits is in the mechanical construction. No interstage shielding is required, and the layout is relatively clean and simple. Several types of tuning me-

chanisms have been used as shown in Fig. 5. Fig. 5A shows a coil used at 200 mc, the inductance variation being accomplished by spreading the turns of the beryllium copper spring coil. The rod diameter was $\frac{1}{8}$ in. Figure 5B shows a conventional brass slug-tuned coil used at 160 mc, which tuned over about 30 mc. The important features of the mechanical construction of the amplifier are the extremely short lead lengths, no wiring being used, the components themselves providing connecting wires, and the care in selection of grounding points.

REFERENCES

- (1) Image rejection, as used in this paper, is the ratio of input to the receiver required to produce standard output with that input signal different from the receiver midfrequency by twice the intermediate frequency to that input required to produce the same output with the input signal at the receiver midfrequency. The image frequency is higher than the desired signal when the receiver local oscillator is lower than the received signal, and vice versa.
- (2) Richards, P. I., Universal Optimum-Response Curves for Arbitrarily Coupled Resonators. *Proc. I.R.E.*, p 624, 34.
- (3) Gain-bandwidth product is the product of center-frequency voltage amplification times the bandwidth between 3-db points. For a pentode with a single tuned coupling network, it can be shown that this product is $g_m/2\pi C_T$, where g_m is the tube's transconductance and C_T is the total capacitance across the tuned circuit; this ratio is independent of center frequency.
- (4) Wallman, H., Stagger Tuned I-F Amplifiers, Radiation Laboratory, Mass. Inst. Tech., Report 524, Feb. 1944. Also R. F. Baum, Design of Broad-Band I-F Amplifiers, *Jour Appl Phys*, Part I, p 519, Part II, p 721, 17. Wallman's analysis leads to the formulas given in this paper as well as those for any bandwidth regardless of center frequency, and are extremely simple to use to obtain flat-topped response. Baum's paper describes an interesting approach which leads to useful results for the general case of n -circuits with a response curve exhibiting peaks and dips within the passband.
- (5) Transitional coupling is defined as that coupling at which the first three derivatives of the transfer impedance are zero.

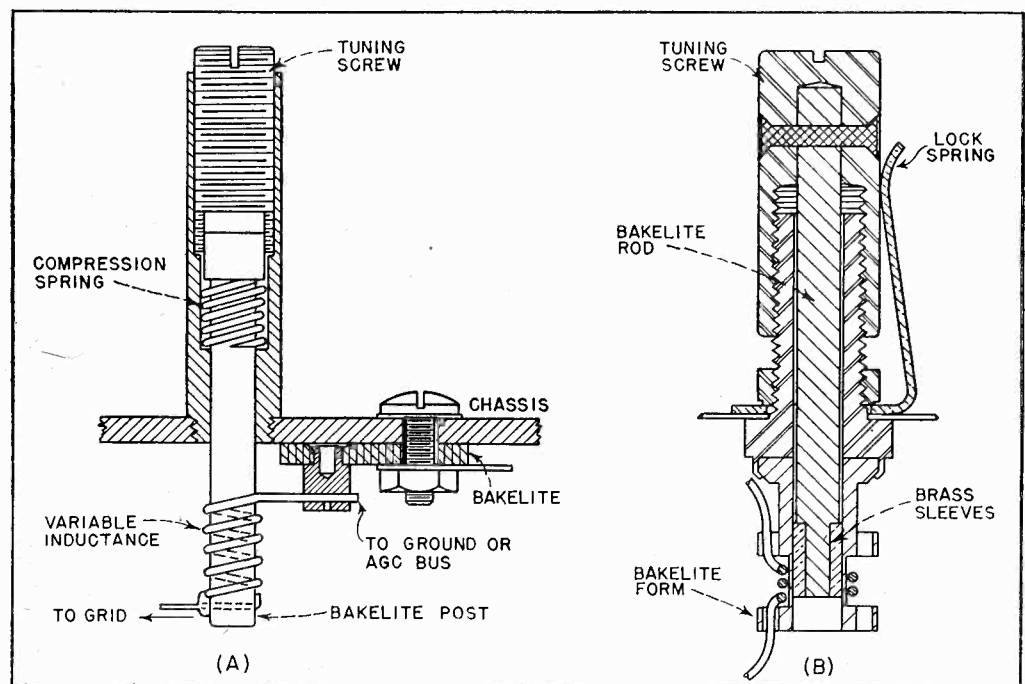

FIG. 5—Two methods of tuning inductors in the vicinity of 100 mc. (A) The coil length is varied. (B) The coupling to a loop is varied

Reverberation Time NOMOGRAPHS

By R. C. GOILE

Colton & Foss, Inc.
Washington, D. C.

Areas of materials in room are measured and number of absorption units of each material is found with first nomograph. Total absorption units are then combined with room volume on second nomograph to obtain directly the reverberation time in seconds

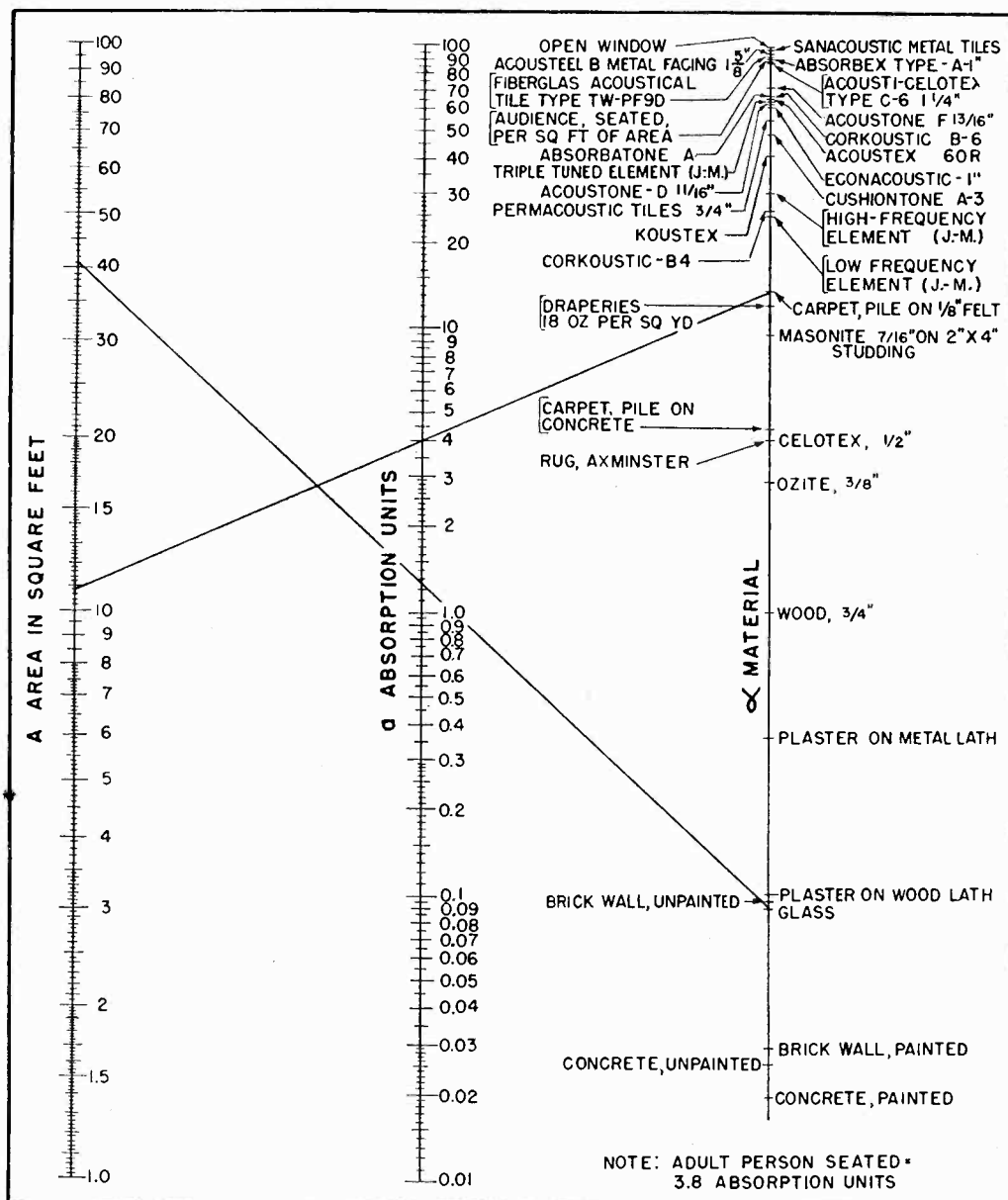

FIG. 1—Acoustical absorption nomograph, based up $a = A\alpha$, where α is the acoustical coefficient of the material

REVERBERATION TIME is the length of time required for the intensity of a sound to drop to one-millionth of its original intensity, which corresponds to a change of 60 decibels. The reverberation time of a room may be computed, knowing the dimensions of the room and the acoustical absorption coefficients of the different surfaces, from

$$T = \frac{0.049V}{A \log_e \left(\frac{1}{1 - \alpha} \right)} \quad (1)$$

where T is the reverberation time in seconds, V is the volume of the room in cubic feet, A is the total surface area in square feet, α is the average absorption coefficient of the room and is equal to $(A_1\alpha_1 + A_2\alpha_2 + \dots) / (A_1 + A_2)$, and α_1 is the absorption coefficient of area A_1 .

This expression may be simplified into an approximate expression accurate enough for the calculation of reverberation time of most rooms

$$T \cong 0.049 \frac{V}{a} \quad (2)$$

where V is the volume of the room in cubic feet, and a is the number of absorption units in the room computed by adding the absorption of each surface: $a = A_1\alpha_1 + A_2\alpha_2 + \dots$

Two nomographs have been designed to facilitate rapid calcula-

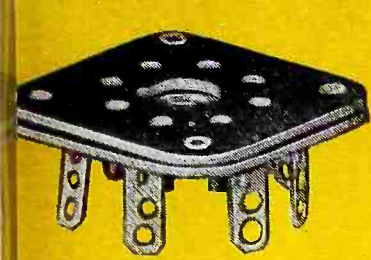

OCTAL
No. 6768—1-5/16"
No. 11C11961—1-1/2"

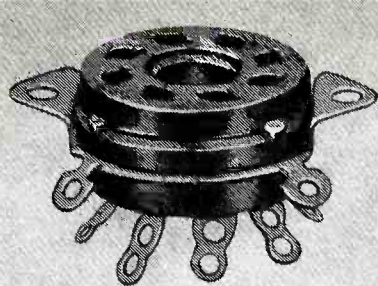

OCTAL
No. 9905—1-5/16" Black
No. 51A12272—Mica



OCTAL
No. 9977—1-1/2" Black
No. 51B11936—Mica

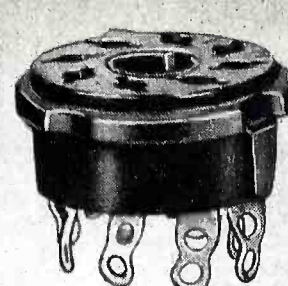

OCTAL
Chassis clinch
No. 9914



MINIATURE
No. 2547

Cinch SOCKETS ARE STANDARD

For about a quarter of a century Cinch has supplied the exacting . . . and changing . . . requirements for radio sockets. Cinch "Know How" often anticipates the need, and Cinch Sockets always fully perform the service required . . . from the hearing aid mite to the condenser holder type. So that today . . . judged by service, by numbers in use . . . and of course by the testimony of its users . . . Cinch Sockets are Standard.



MINIATURE
No. 53C12136—Black
No. 53C12360—Mica



MINIATURE
No. 2557

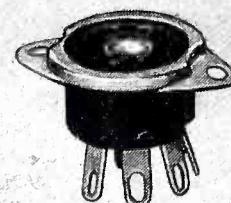

MINIATURE
No. 9337—Black
No. 53A12364—Mica



MINIATURE
No. 56B12538

CINCH
MANUFACTURING
CORPORATION
2335 W. Van Buren Street
CHICAGO 12, ILLINOIS
SUBSIDIARY OF
UNITED-CARR FASTENER CORP.
Cambridge 42, Mass.

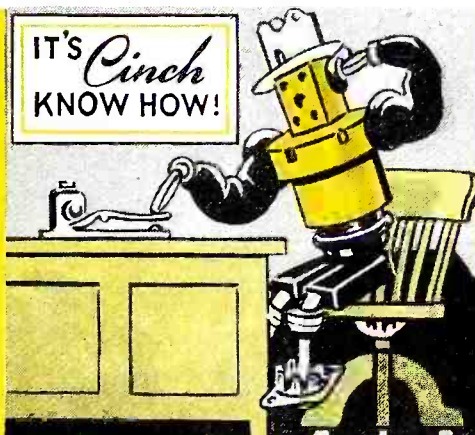

MINIATURE
No. 53C11774—Black
No. 53C12365—Mica



SUB-MINIATURE
No. 54A11953—5 Prong
No. 54A11955—6 Prong
No. 54A11957—7 Prong



LOKTAL
No. 6972—1-5/16" Black
No. 52A12354—Mica



LOKTAL
No. 6933—1-5/16"



MINIATURE
Chassis clinch
No. 53E11767

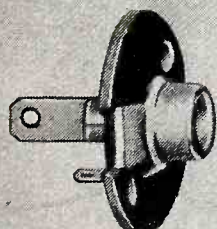

No. 8134

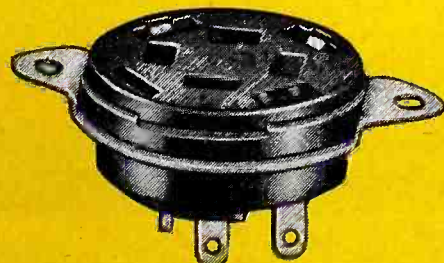

CONDENSER
No. 54A11897

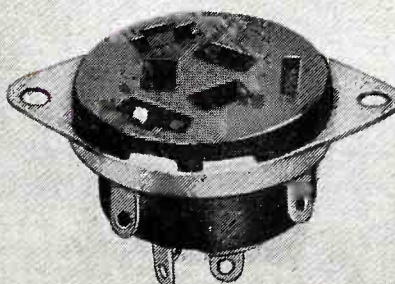

CONDENSER
No. 54A11523



WAFER
No. X154 4 Prong
No. Y154 5 Prong
No. A154—7 Prong (large)
No. Z154 6 Prong
No. U154 7 Prong

TUBES AT WORK

Edited by VIN ZELUFF

Intermittent Mobile Tube Ratings.....	146
Two-Way Taxicab Radio Circuits.....	146
AFC at 10 Centimeters.....	148
Frequency Meter for 50 to 600 Mc.....	148
Two-Way Teletype In Air.....	168
Measuring High Potentials.....	172
Broadcast Carrier System.....	174

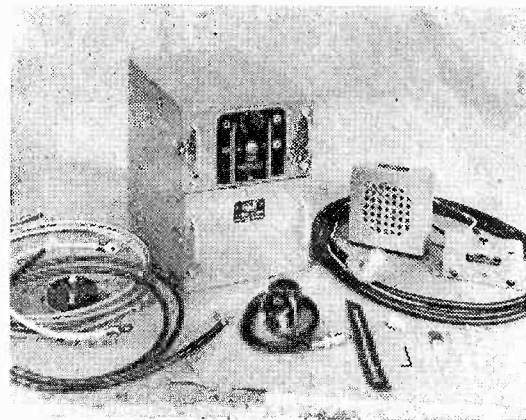

All items needed for a two-way radio installation in a taxicab

Intermittent Mobile Tube Ratings

IMS STANDS for intermittent mobile service such as in aircraft, where transmitter design factors of minimum size, light weight, and exceedingly high power output for short intervals are the primary requirements, even though the average life expectancy of tubes used in such transmitters is reduced to about 100 hours.

According to RCA, IMS ratings

are based on operation where the transmissions have maximum "on" periods of 15 seconds followed by "off" periods of at least 60 seconds, except that it is permissible to make equipment tests with maximum "on" periods of 5 minutes followed by "off" periods of at least 5 minutes provided the total "on" time of such periods does not exceed 10 hours during the life of any tube.

Two-Way Taxicab Radio Circuits

DESIGNED for mobile taxicab service, in the frequency range from 152 to 162 megacycles, the Comco 210 transmitter-receiver possesses some interesting circuit arrangements.

The transmitter is crystal controlled and uses narrow swing frequency modulation. The receiver is a dual-conversion crystal-controlled superheterodyne with 17 tubes and 24 tuned circuits and has a sensitivity of better than one microvolt. It has a bandwidth of 32.5 kc for

2 × down (6 db) and 106 kc for 1,000 × down (60 db).

Transmitter

A block diagram of the transmitter is shown in Fig. 1. Filament type tubes permit instant heating. The crystal controlled oscillator section of the 3A5 tube supplies r-f voltage to the 2E25 balanced modulator grids. The plates of the modulator tubes are connected in parallel and the output circuit tuned to that of the crystal. The output of the

audio section of the 3A5 tube is fed to the modulator grid, thru a low-frequency network. The a-f voltage so impressed on the grids causes a relative phase shift in the output frequency of the modulators.

The next three stages, using 2E25 tubes, result in an overall frequency multiplication of 24 times. Following these, a 3D23 driver doubles the frequency and provides excitation to the final 3D23 power amplifier. This stage connects to the antenna through a changeover relay which permits receiver operation when not transmitting. Meter shunt resistors are connected in the grid return of the various stages and, with a selector switch, permit the use of a single meter for checking grid drive and tuning all circuits except the antenna.

The receiver block diagram is shown in Fig. 2. The amplified signal from the 9001 r-f stage is impressed upon the first mixer, a 6AK5. Proper injection voltage is obtained from the 1T4 fourth doubler stage, at a frequency sixteen times that of the 1T4 crystal oscillator. The output from the first mixer is coupled to the second 6AK5 mixer, which obtains its injection voltage from the second doubler.

Double Limiter

Output from the second mixer is amplified through three i-f stages, using 1T4 tubes. The third i-f stage is coupled to the first 1T4 limiter, from which point the avc voltage which is applied to the two mixer and three i-f stages is also obtained. Overall gain from the antenna to the first limiter grid is sufficient to provide saturation of the grid by internal set noise.

The second limiter is transformer

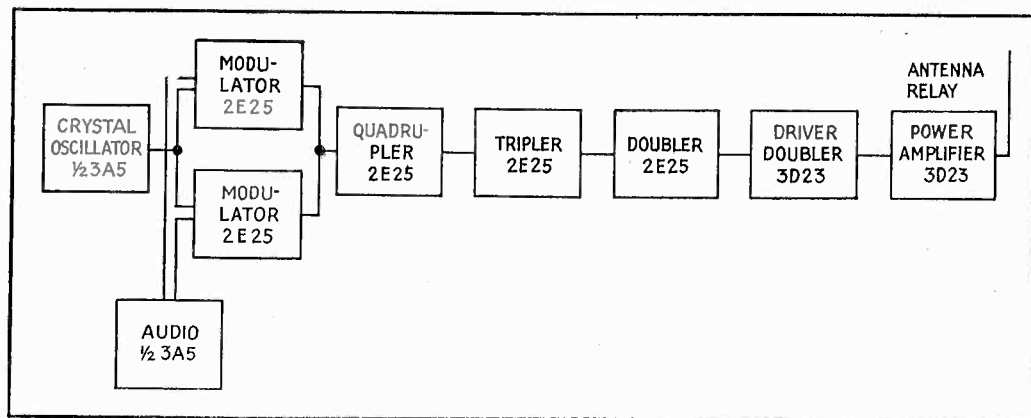

FIG. 1—Stages of the f-m transmitter for mobile service; both transmitter and receiver are on one chassis



GUARDIAN

stepping relays

FOR SELECTION AND CONTROL OF MULTIPLE CIRCUITS

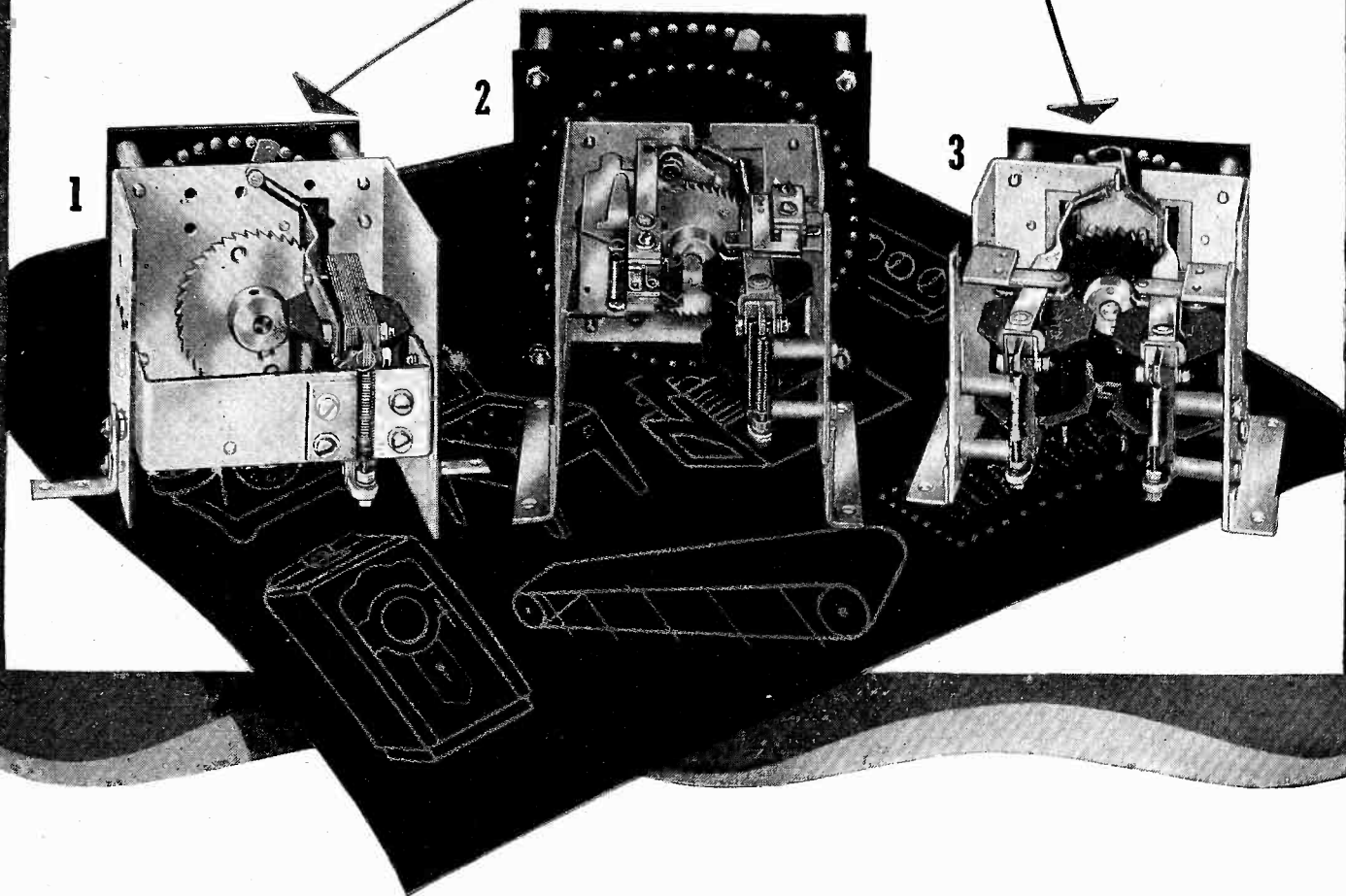

This trio of standard Guardian Stepping Relays: (1) continuous rotation, (2) electrical reset, (3) add and subtract—will start you off with a minimum of design and keep your product operating indefinitely. The Guardian Steppers shown are adaptable to numerous applications: automatic circuit selection; automatic sequence selection of circuits; automatic sequence cross-connection of circuits. They are used in automatic business machines, production totalizers, conveyor controls, animated displays, telephony, remote tuning, with a host of additional uses you will soon discover. On each, the contact finger rotates counter-clockwise. All three Steppers follow 10 pulses per second within the rated voltage range of the relay. Special construction prohibits skipping or improper indexing of the ratchet. Available in separate units or in combination with relays, contact switches, solenoids; completely assembled and wired to terminals; mounted on special bases or in enclosures. "Special" modifications are obtainable in production quantities. Write for Bulletin SR.

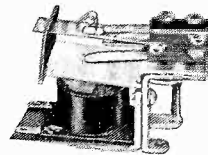

Series 100 Snap-Action Relay

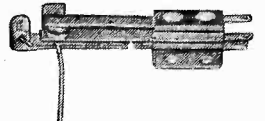

Guardian Featherub Switch

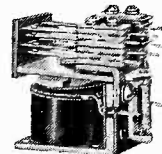

Series 500 Midget Relay



Series 1-A Solenoid

GUARDIAN



ELECTRIC

1625-D W. WALNUT STREET

CHICAGO 12, ILLINOIS

A COMPLETE LINE OF RELAYS SERVING AMERICAN INDUSTRY

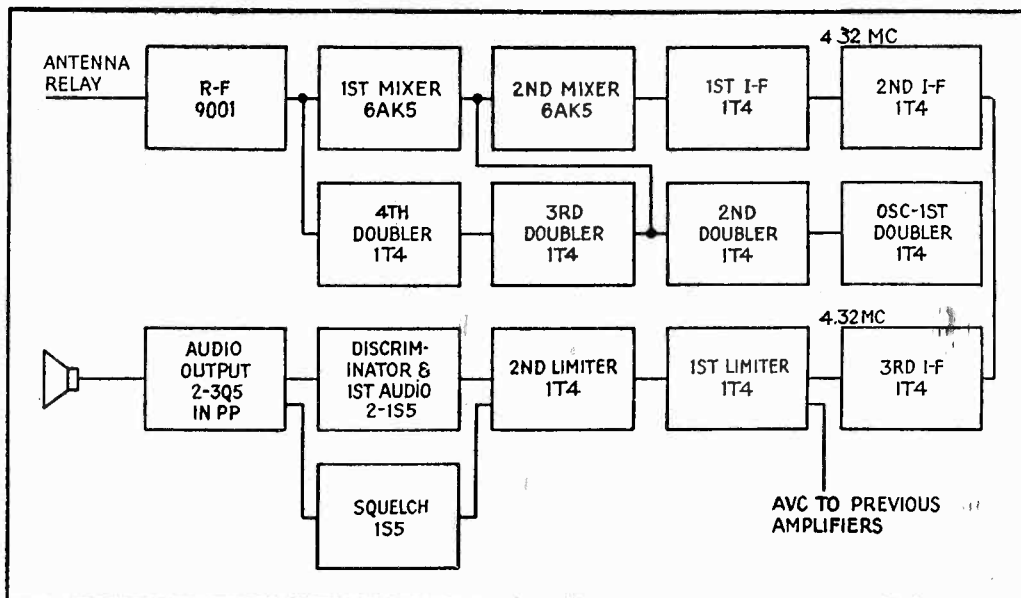

FIG. 2—In the Communications Company receiver, the same crystal oscillator is used for each mixer. The first mixer uses the sixteenth harmonic and the second mixer uses the fourth harmonic

coupled to the diode plates of the two type 1S5 tubes. The pentode sections of these tubes serve as pushpull a-f amplifiers for the out-of-phase audio voltage developed across the discriminator diode load resistors. Two 3Q5 tubes serve in the pushpull audio output stage.

Squelch Circuit

In the absence of a signal, the limiters are saturated by shot noise and considerable a-f noise voltages are developed in the plate circuit of the second limiter tube. This noise voltage is coupled through a high-pass filter to the grid of the 1S5 squelch tube. This filter removes the low-frequency audio components below 12,000 cps, preventing the possibility of carrier modulation tripping the squelch. After amplification by the pentode section of the 1S5 squelch tube, the noise voltage is applied to the 1S5 diode. The negative voltage developed across the diode load resistor is used to bias the pushpull a-f tubes near cutoff.

When a signal is received of sufficient strength to override the noise level, the noise voltage from the second limiter disappears. Thus the cutoff bias is removed and the 3Q5 tubes are restored to normal bias

and operation. Positive squelch operation is further obtained by means of a relay in the plate and screen supply circuit of the 3Q5 tubes which operates when the bias is applied from the squelch circuit. In the squelched condition, the relay is open and the relay contacts short the speaker voice coil circuit to ground. Upon receiving a signal, the relay is closed, and in addition to removing the ground from the voice coil circuit, it closes the circuit to the red indicator lamp on the control panel.

On single-channel operation, the squelch circuit is so adjusted that a sharp whistle in the microphone causes the red lamp to flicker thus giving the driver a means of checking both transmitter and receiver circuits for correct operating conditions.

In addition, the receiver is so designed that adjustment of the transmitter frequency may be made using the readings of the receiver discriminator circuit which has previously been checked against the headquarters transmitter. This technique eliminates the need for any frequency checking equipment except at headquarters, unless crossband operation is used.

AFC At 10 Centimeters

AUTOMATIC frequency control of a centimeter-wave oscillator is done by G.E.C. of Great Britain by first feeding a small part of the output of a velocity-modulated oscillator

operating near 10 centimeters into a cavity resonator. The resonant frequency of the cavity is varied at 50 cps by an oscillating plunger in its base and the output voltage is

rectified and fed into a phase discriminator.

If the mean resonant frequency of the cavity is the same as that of the oscillator, the discriminator voltage is zero, but if the frequencies are different an out-of-balance voltage is produced by means of which the oscillator frequency is automatically adjusted to equal the mean frequency of the cavity.

Frequency Meter for 50 to 600 Mc

By J. W. WHITEHEAD
Yorkshire, England

ALTHOUGH absorption wavemeters are available for the measurement of transmitter frequencies operating up to and around 50 cms, heterodyne wavemeters for the calibration and adjustment of receivers at these frequencies are not readily available. To meet this need, United States Army type BC-221 frequency meters were modified to cover the band from 50 to 600 mc.

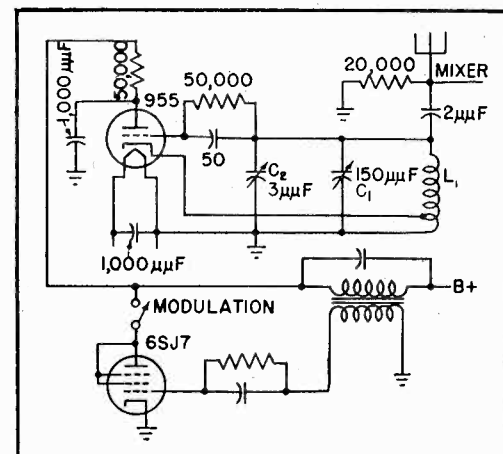

New r-f oscillator and modulator circuits for the BC-221

The new circuit is shown in Fig. 1. The existing r-f oscillator is removed and is replaced by an electron-coupled circuit incorporating a 955 acorn tube. A new inductance L_1 is wound with an internal diameter of $\frac{1}{8}$ inch, composed of three turns of 0.05-inch diameter silver-plated copper wire. Together with other associated components, this is mounted on the main tuning capacitor C_1 .

The fundamental frequency range of this oscillator is from 50 to 100 mc, and large harmonics up to at least the sixth are readily generated. The antenna to mixer coupling

(continued on p 166)

Can you use a Frequency Standard accurate to One Part in 100,000,000?

The new Western Electric Primary Frequency Standard for 100 kc operation—accurate to one part in 100,000,000—fills every need for a precise frequency source. It's rugged in construction, small in size and weighs only 90 pounds. It is designed for fixed or semi-portable service wherever time-frequency measurements or the synchronous operation of two or more independent systems is required.

Developed by Bell Telephone Laboratories, the new Frequency Standard was used during the war as a Loran frequency source of the utmost accuracy. Rugged enough to withstand hard use, the Standard maintains a frequency accurate to *one part per 10⁸ per day* irrespective of moderate changes in ambient temperature, humidity, and air pressure. Actual tests in a Government laboratory have shown a frequency variation of less than *1.4 parts per 10⁹ per day*.

For literature or further details, call your nearest Graybar representative, or write to Graybar Electric Company, 420 Lexington Avenue, New York 17, N. Y.

Western Electric

— QUALITY COUNTS —

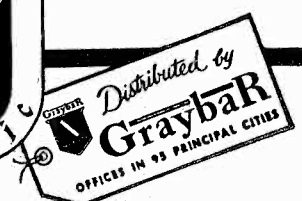

INDUSTRIAL CONTROL

Edited by VIN ZELUFF

Radar for River Towboat Traffic.....	150
Electronic Seismograph	150
Improved GCA for Navy.....	182
16,000 Tubes Work for One Railroad.....	186
Motor Control for Polio Patients.....	188

Radar for River Towboat Traffic

MARINE RADAR on river towboats has been given winter tests in experimental runs on the Ohio and Mississippi rivers. The tests were conducted by the Ashland Oil and Refining Company, the U. S. Coast Guard and Sperry Gyroscope Company.

River navigation is carried on under extremely close restrictions compared to navigation on the open sea and ever since the first steamboat trip from Pittsburgh to New Orleans, river pilots have been unable to navigate in heavy fog. The only thing a pilot can do is to stay tied to the bank until the fog lifts, which may be any time from one to twelve hours. There have been instances of boats being fog-bound for as long as two days. Fogs are particularly prevalent in the Ohio Valley in the autumn and may limit visibility to less than 20 or 30 feet. One-thousand foot length of barges

out in front of the towboat is not uncommon.

Capt. Kent Booth, master of the *Tri-State* towboat used in the tests, said the Sperry radar showed clearly the shore line of the river, approaching craft which were beyond view, boats tied to the bank, bridges and power lines crossing the river, locks and dams and other objects.

One incident that convinced the master of radar's sensitivity occurred on a night run between Pt. Pleasant and Kenova, West Virginia. "At one point," he said, "something showed up on the radar scope that we thought was a buoy. We looked out but couldn't see any buoy light, and then ordered the searchlight turned on it. It was a gallon oil can."

The radar set aboard the *Tri-State* is identical to the equipment which has been through all-



Radar antenna aboard the *Tri-State* for its trial run as a commercial navigation aid on the Ohio River



Advantages of radar on inland rivers are illustrated by this ppi presentation. The center dot shows the ore-carrier *Frank Armstrong* after passing seven vessels anchored because of fog. Ahead, to left of heading flasher, are a lookout station and buoy. At right is a log boom and pilings. Near Sault Ste. Marie Canal, 18 anchored vessels were passed in the fog

weather testing aboard Interlake's ore-carrier *Armstrong* in the Great Lakes and Sperry's laboratory yacht *Wanderer* in the Atlantic, the lakes, rivers, harbors and canals.

The Coast Guard installed radar targets at four points along the Ohio to aid in checking the operation of the radar aboard the *Tri-State*.

Electronic Seismograph

By R. L. ARRINGDALE

Director of Research
Diamond Instrument Co.
Wakefield, Mass.

THE FIELD of seismology is divided roughly into two branches; prospecting, which is used by the larger

(Continued on p 178)

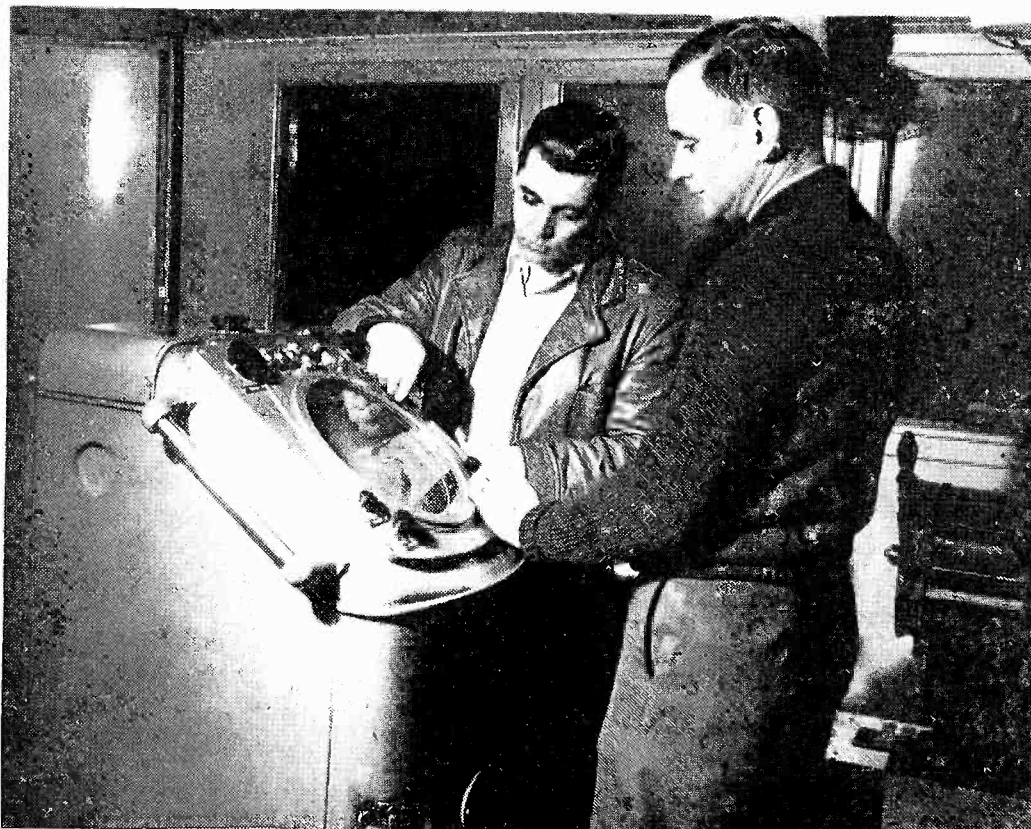

Movement of Ashland Oil's river barges in fog is speeded up by this Sperry radar. Capt. Booth, right, of the *Tri-State*, discusses the ppi with an engineer

Kodak

*Uniquely
versatile...*

... this new, simple way to put lasting reproductions on products

The KODAK TRANSFAX PROCESS

**Its application . . .
limited only by
your own ingenuity**

You can reproduce almost any marking directly on metal, plastic, any nonporous surface with utmost accuracy . . . get crisp, clear images of drawings, designs, legends, lettering.

Color effects . . . white Transfax can be applied on any color surface—using the color as the background, or reversed, using Transfax as the background—to give you a variety of color arrangements.

Scales

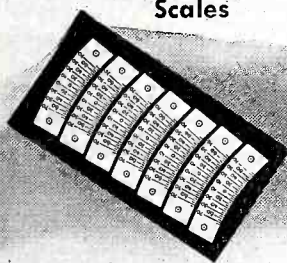

Name plates



Templates

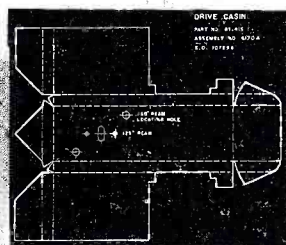

Dials

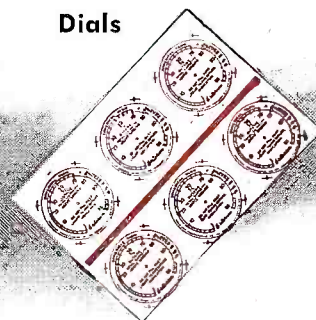

**Its operation . . .
fast, simple,
inexpensive**

1. Spray Transfax directly on the product's surface. With some surfaces a priming coat is necessary.
2. Place transparent or translucent original on sensitized surface and expose to strong light.
3. Wash with dilute Kodak Transfax Clearing Solution . . . and overcoat with clear lacquer.

The cost is low . . . neither darkroom nor special skill is necessary—and time required is as little as 5 minutes.

**It's long-lasting . . .
doesn't deteriorate
with age**

Transfax copies when overcoated are tough, rubproof, oilproof . . . they don't deteriorate or change color with age . . . and they have heat resistance sufficient to hold fast in flame cutting.

*Can TRANSFAX
be used in your
operation?*

Probably in more ways than you realize. Tell us about your product . . . the marking you want to reproduce . . . the type of surface involved. Let us send you complete information on the Transfax Process with full consideration for your particular needs.

EASTMAN KODAK COMPANY
Industrial Photographic Division • Rochester 4, N. Y.

KODAK TRANSFAX PROCESS

... a revolutionary new reproduction process

THE ELECTRON ART

Edited by FRANK ROCKETT

Pilotless Airplane and Missile Control.....	152
AIEE Winter Meeting—A Technical Summary.....	192

Pilotless Airplane and Missile Control

HIGH-SPEED, high-altitude aircraft and missiles cannot be satisfactorily controlled directly by human pilots. Such pilotless airborne vehicles include rockets to the stratosphere and moon, mail delivery rockets, aircraft undergoing severe flight testing, and guided missiles, either projectiles or bombs. Application and improvement of these vehicles require extension of electronic techniques used to control their flight.

Functions of Pilot

Performance provided by electronic plots can be broken down into several functions.¹ As all aircraft or missiles are intended to reach a particular objective, the piloting mechanisms must provide *target detection*. Detection may be performed in a number of ways, either

by orientation of the launching of the missile, as was used in several glide bombs and rockets, or by detecting heat, by television (ELECTRONICS, p 268 Jan 1946), or by radar (ELECTRONICS, p 268 Feb 1946).

It is necessary to track the target to correct for variations in flight path or target position. That is, an additional function of *acquisition* needs to be added to the search function. Associated with target acquisition is a computer to anticipate necessary changes in trajectory. In the case of the television bomb (ELECTRONICS, p 482 Nov 1945), a bombardier remotely controls the bomb from the mother plane by watching the television image transmitted from the bomb. In the radar-controlled bomb (ELECTRONICS, p 186 Dec 1946), the bombardier centers the forward scan-

ning radar carried by the bomb on the target before the bomb is released; thereafter the bomb automatically homes on the target as tracked by its own radar.

Acquisition operates through the *guidance* function to supply movement to the aerodynamic controls of the missile or aircraft. Guidance is performed by usual electronic autopilots as used in commercial and military airplanes to relieve pilots of purely routine functions and the need to exert large controlling forces. The signals developed by the acquisition function and its associated computers control the guidance mechanism. These functions can be performed by combinations of familiar electronic circuits adapted to the tactical requirements.²

Means of Control

Authority for guidance can be placed at several points. In the *preset* system, the parameters of the trajectory to the target are set at the time of launching by aiming the missile. An elaboration provides navigation whereby coordinates are established either by the earth's magnetic field, as in the V-1 which carried a compass to keep it on its initial course, or by such radio techniques as loran. The trajectory can be modified by *external* command as has been done in radio-controlled aircrafts used in gunnery practice (ELECTRONICS, p 300 Dec 1945) and in drones (ELECTRONICS, p 262 Feb 1946). In the Azon and Razon bombs, command of the fall is performed by radio control of the fins by the bombardier who observes the flight of the bomb, made visible at night by a tail flare.³ The missile can provide its own target tracking signal, in which case command is by *homing* as in bombs that fall toward heat-radiating targets or targets located by the bombs' radars. In the case of command from beyond the missile or aircraft the data is transmitted to it by telemetering.

Development of Autopilots

The assault drone, used to obtain samples of radioactive gases at the Bikini⁴ atomic bomb tests (ELECTRONICS, p 294 May 1946, also p 330 April 1946), grew out of the radio-

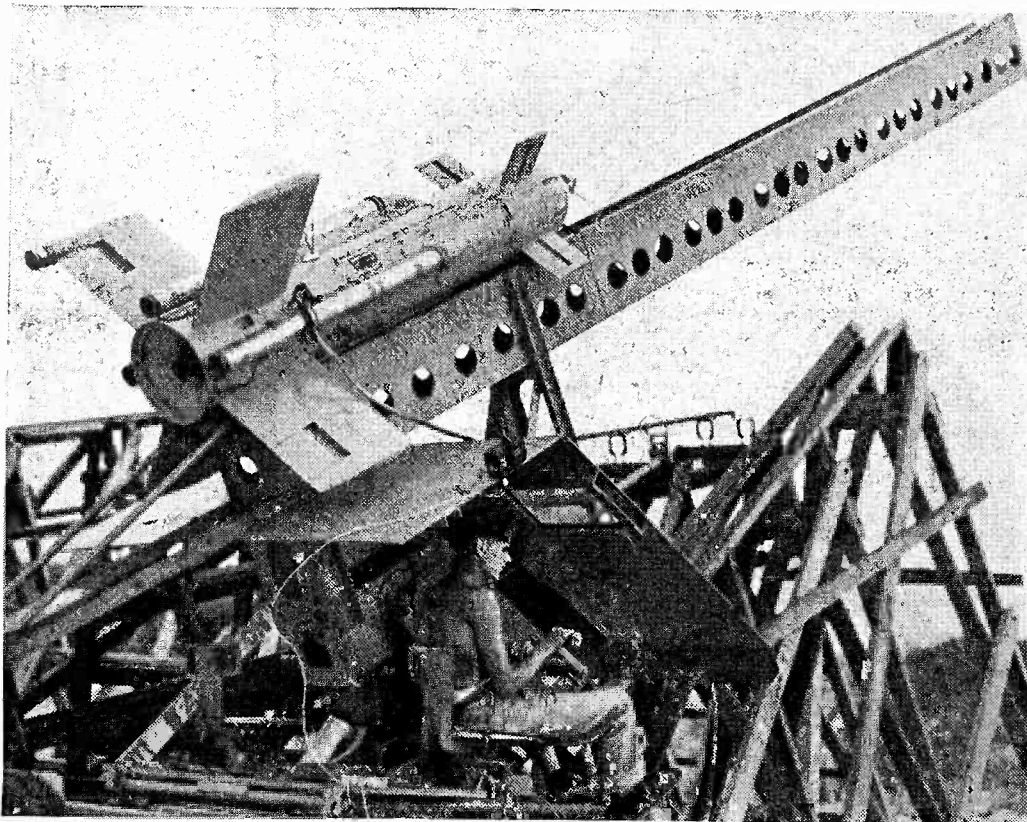

Self propelled missiles that can be launched either from a ship or an airplane were developed. This one is powered by four rockets at take off and by jet propulsion while in flight. A flare mounted on one wingtip enables the radio control operator at the launching position to follow the missile in flight. A proximity fuze detonates the missile when it approaches the target

These Newspapers Have Selected

FM^{by} Federal

for their new Broadcast Stations



**ALL WILL BE ON THE AIR
BY EARLY 1947**

MEN WHO KNOW news pick the "big news in radio" — FM by Federal. From New York to Nebraska — from Wisconsin to Kentucky — these eighteen newspapers in eleven states are going on the air with new FM broadcasting stations. And — like so many major radio stations from coast to coast — they have *all* selected Federal equipment.

FM, in itself, means better broadcasting. But FM by Federal means FM at its best — the last word in center-frequency stability, radiation strength, and long trouble-free operation. Federal's 38 years of research and experience are at your service — to design, equip and install your complete FM station. Write today for detailed information. Dept. B113.

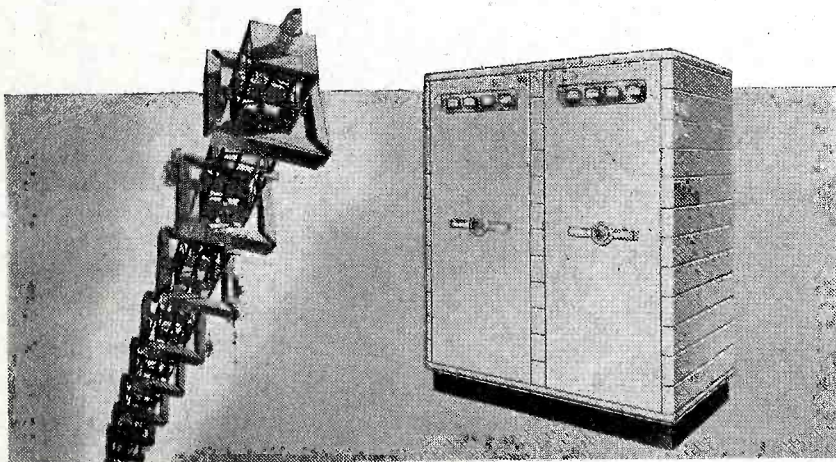

Federal's **SQUARE-LOOP ANTENNA** gives added effective radiation strength — up to 8 times that of the rated transmitter output.

The "**FREQUEMATIC**" MODULATOR is an exclusive feature of every Federal FM transmitter — assuring greater center-frequency stability, simplicity of operation and longer life.



Federal Telephone and Radio Corporation

In Canada — Federal Electric Manufacturing Company, Ltd., Montreal.
Export Distributors: — International Standard Electric Corp. 67 Broad St., N.Y. C.



Newark 1,
New Jersey

controlled target drone. Guidance from the ground or mother craft can be provided for these on the basis of information presented by television (ELECTRONICS, p 332 April 1946, also p 298 May 1946) or by radar. Command type of guidance is relayed to the drone by telemetering usually from the operator's controls.

Visibility, especially in overcast or at night, is an essential prerequisite to pilotless control. In the gravity-propelled Bat, a radar in the nose provides the visibility necessary to locate a target (detection). The radar scanner tracks the target (acquisition). The error signal from the scanner actuates the aerodynamic control surfaces (guidance of the homing type). Radio proximity fuzes (ELECTRONICS, p 110 Nov 1945, also p 226 and p 228 Jan 1946), developed for bombs, rockets,⁵ and anti-aircraft⁶ munitions and used to detonate the radio-controlled, rocket-propelled missile (ELECTRONICS, p 206 March 1946) designed to attack the Kamikaze planes, afford visibility of the target to the missile.

Performance of individual circuits necessary to provide the functions outlined above are generally similar to those developed by the electronic industry for other purposes. The requirements for use in guiding missiles include operation at extremes of temperature and at high altitudes and high accelerations. Transmission and reception of electromagnetic energy



Drone target planes, such as this one for which some improvements are being planned, served as the proving ground for development of remotely controlled aircraft. Circuits used to control target drones were adapted to guide Weary Willies, warweary B-17's loaded with ten tons of explosive, which were flown by control from mother planes in formation with conventionally manned planes until within sight of the target. The Weary Willies then proceeded alone in power dives into the target

(radio and heat waves in particular) present problems of antennas. Due to high velocities of these airborne vehicles, external antennas are prohibited. The antennas can be inside the structures and provided with electromagnetic windows and lenses, or radiation can be through holes in the surface, such as the slot antenna.

Another possibility is to have portions of the missile function as the antenna.

The ultimate accuracy with which the vehicle can track its

target depends on noise. The noise from beyond our atmosphere, especially from the sun (ELECTRONICS, p 200 Aug 1946, also p 290 June 1946), may render missiles blind in certain directions. (The Germans had developed an anti-aircraft rocket that homed on heat from an airplane's exhaust, but it frequently attempted to home on the sun.) Other sources of noise are scattered and reflected radiation due to yaw and pitch of the target and the missile, and perturbation of the plane of polarization produced by random reflections. To determine the magnitudes of these noises, propagation studies are being made, both of the transmission of the ionized layer to radiation

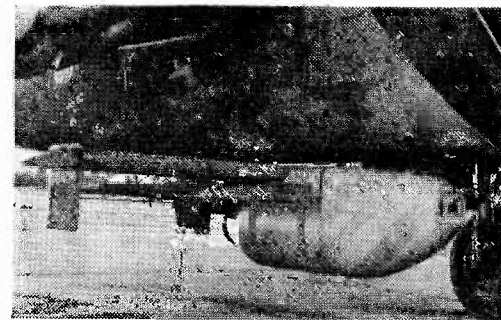

Glide bombs and glide torpedoes are carried by long range bombers to target areas, but not to within range of target defenses, and released. The missiles travel at between 200 and 300 miles an hour in gliding toward the target, falling one foot for every six feet traveled forward. This glide bomb homes on the target by television. An air frame consisting of wings, control surfaces, and a homing head suitable for the type of target being attacked is attached to conventional bombs or torpedoes

from beyond the earth^{7,8} and of its reflective properties (ELECTRONICS, p 264 August 1946, also p 262 July 1946). Related to the problem of noise is that of effective target area for the type of detection used, and the problems of generating high powers and detecting weak powers. There are also limitations presented by the atmosphere such as resonance absorption of certain frequencies and the bending of radio waves by temperature and humidity gradients in the atmosphere that are not fully understood. The reliability with which pilotless vehicles can be controlled in flight thus depends on many factors, but tests (ELECTRONICS, p 296 May 1946) show that the problems are not insolvable.

(1) Piore, E. R. and R. M. Page, Elec-
(continued on p 192)

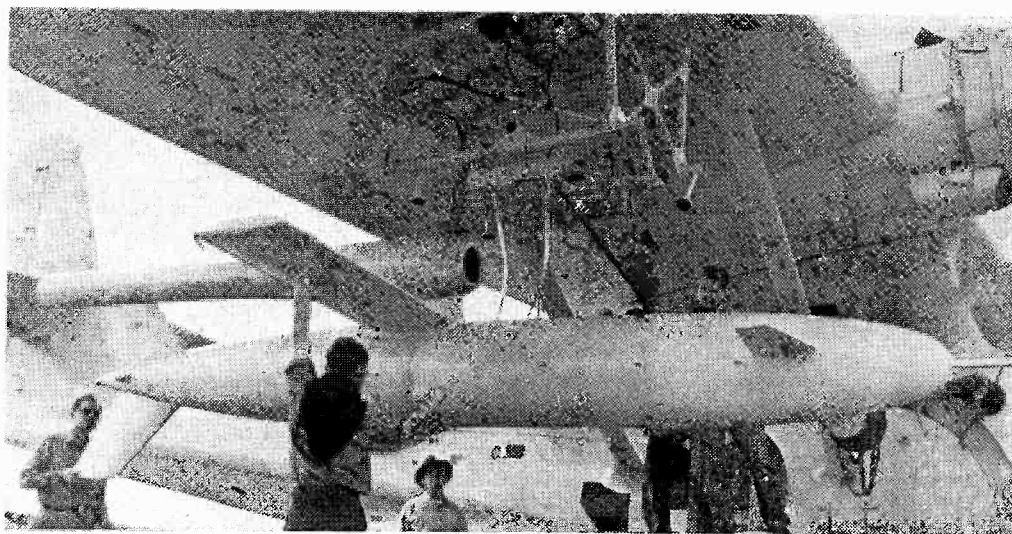

To extend the accurate range from which a plane can launch its bomb load toward a target, rocket driven bombs are used. In this rocket driven bomb (the rocket engine is above the body of the bomb), a compass in the nose provides directional sense. The rudder at the tail and the elevators near the nose are controlled by individual servoes from a gyro control. Air, fuel, and explosives are carried in the main body

"WHEN EQUIPMENT IS STILL IN THE BLUEPRINT STAGE..."



AND VOLTAGE VARIATIONS MAKE YOU RANT AND RAVE



... LET A SOLA 'CV' MAKE THAT VOLTAGE BEHAVE"

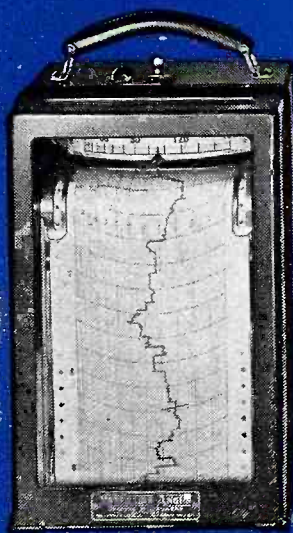

Fluctuating Line Voltage

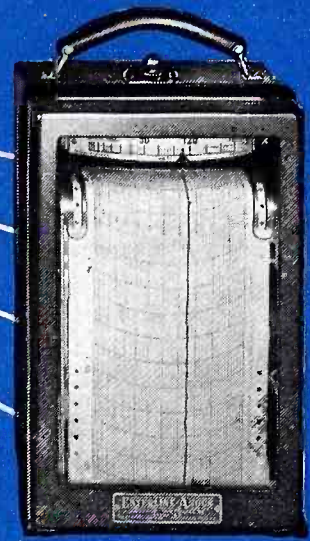

Constant Output Voltage

It may look good on paper . . . and perform superbly under regulated laboratory voltages, BUT . . . when it encounters the *unstable* voltages that are available to your customers, what happens—

- to costly filaments and tubes?
- to precision parts?
- to sensitive, balanced circuits?
- to over-all efficiency?
- to customer good-will?

The operating voltage you specify will never be consistently available unless you make provision for it. That can be done most economically and satisfactorily by including an automatic, self-protecting SOLA Constant Voltage Transformer as a "built-in" component of your equipment.

There are many standard models in SOLA Constant Voltage Transformers that have been specifically

designed for built in use. They are being successfully used today by many manufacturers of electrically energized equipment who have *guaranteed* the availability of constant rated voltage. May we make a recommendation for your equipment?

Write for Bulletin
DCV-102

Here is the answer
to unstable voltage
problems.

SOLA *Constant Voltage* TRANSFORMERS

Transformers for: Constant Voltage • Cold Cathode Lighting • Mercury Lamps • Series Lighting • Fluorescent Lighting • X-Ray Equipment • Luminescent Tube Signs
Oil Burner Ignition • Radio • Power • Controls • Signal Systems • etc. **SOLA ELECTRIC COMPANY, 2525 Clybourn Avenue, Chicago 14, Illinois**

Manufactured in Canada under license by FERRANTI ELECTRIC LIMITED, Toronto

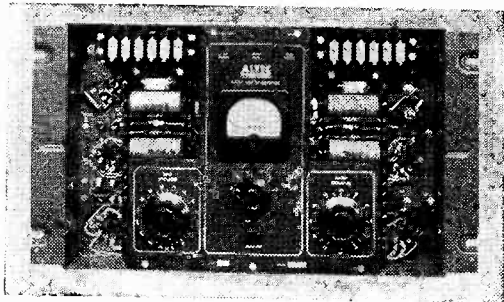

output beyond this point. A meter having a 100 percent point and calibrated in DB LIMITING permits the operator at all times to know the amount of limiting taking place. When desired a remote meter can be connected. Provisions are also made so that the NAB-orthacoustic preemphasis equalization which is a built-in feature can be utilized since the limiting is controlled from the preequalized voltage. With proper balancing the thump when limiting, will be 50 db down from the signal level. Gain at 1000 cycles with the equalizer out is 68 db; with the equalizer in, it is 60 db. Hum and noise with the equalizer out is -45 db; with the equalizer in it is -52 db. Frequency response with the equalizer out is ± 1 db 20 to 20,000 cycles. Normal limiting threshold is + 17.2 db. The attack time is 0 to 0.0002 second and the release time is normal at 0.5 second.

Snap-Action Switch (6)

UNIMAX SWITCH CORP., a Subsidiary of The W. L. Maxson Corporation, 460 West 34th St., New York 1, N. Y. The Unimax moving member of heat-treated beryllium copper, with tongue ribbed for maximum

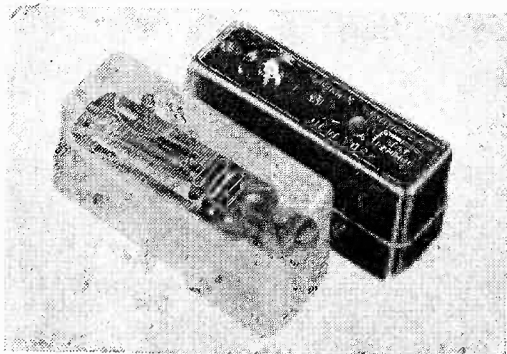

stability, gains a uniform characteristic from the folded flat spring section which exerts high contact pressure and produces instant traverse. The nonrotatable actuator button assures an application of force to the same spot on the tongue throughout life of the switch. Con-

tacts are silver, laminated on copper; the moving contact has a low mass for minimum contact bounce. For convenience in production assemblies, one mounting hole is elongated. Overall dimensions of the molded phenolic case are $1\frac{1}{8} \times 1\frac{1}{8} \times 1\frac{1}{8}$ inch. Electrical ratings: 15 amp, 125 volts; 5 amp, 250 volts; $\frac{1}{2}$ hp, 115 to 460 volts, 60 cycles; all units are spdt.

VHF-UHF Load Resistor (7)

BIRD ELECTRONIC CORP., 1800 E. 38 St., Cleveland 14, Ohio. The model 69 Termaline resistor is the latest development in low vswr coaxial loads. For laboratory and production tests it offers a constant re-

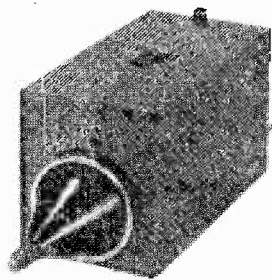

sistance of 51.5 ohms through a frequency range from d-c to well over 1,000 mc. Without auxiliary cooling, it will dissipate 300 watts; connected to tap water supply, (through hose stems at rear of unit), it will handle 1 kw with ease. Flow rate of $\frac{1}{2}$ gallon of water a minute is satisfactory. At frequencies below 100 mc, the r-f resistance is within 2 percent of the d-c resistance and reactance component is very small. The d-c resistance is held to ± 5 percent. Above 100 mc typical voltage standing wave ratios for a 51.5-ohm d-c resistor lie between 1.02 and 1.04. In addition to the N connector shown, the unit can be furnished with larger connectors.

A-C Relay (8)

ELECTRO-SWITCH AND CONTROLS CO., Box 453, Culver City, Calif. Originally designed for 400-cycle aircraft inverter control, the relay illustrated operates satisfactorily in the frequency range 10 to 10,000

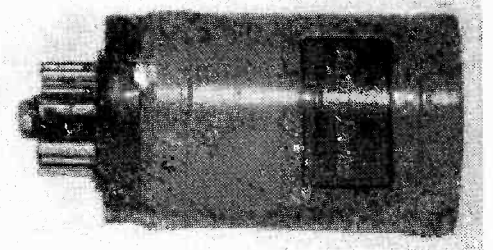

cycles. It is hermetically sealed, will operate in an ambient temperature in excess of 250 degrees F, and is said to contain a new type of rectifier. It is available in ratings up to 10 amperes at 120 volts a-c or 24 volts d-c with contact assemblies up to 3pdt in the octal base type or with screw terminals.

Insulation Resistance Meter (9)

ASSOCIATED RESEARCH, Inc., 231 South Green St., Chicago 7, Ill. The Model 261 Vibrotest is a self-contained portable testing meter that measures resistance up to 50,000 megohms on a scale that is centered at 1,200 megohms. Tests are made at 500 volts, provided from a pair of dry cells and a vibrator circuit, so that no cranking is necessary. Accuracy is maintained by a voltage regulator in the measuring circuit. Housed in a weatherproof steel case, the portable unit weighs $17\frac{1}{2}$ pounds.

Signal Generator (10)

PREMIER ELECTRONIC LABORATORIES, 382 Lafayette St., New York 3, N. Y. A new precision tuning signal generator Model No. 570 is specially designed for f-m and television alignment. Frequency range covered is from 75 kc to 50 mc on fundamentals and up to 150 mc on the

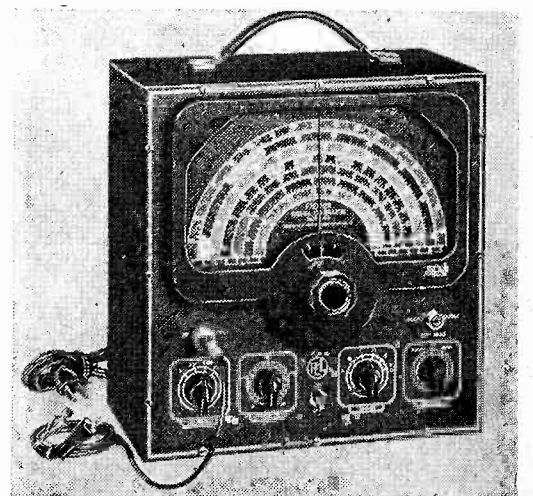

EVERY DE MORNAY-BUDD WAVE GUIDE is Electrically Tested, Calibrated and Tagged

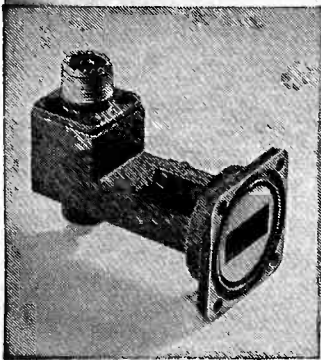

Crystal Mount DB-453

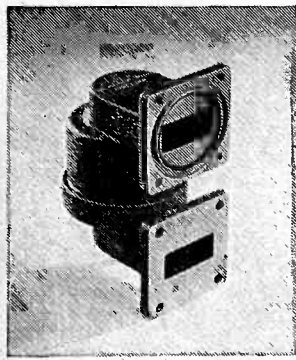

Rotating Joint DB-446

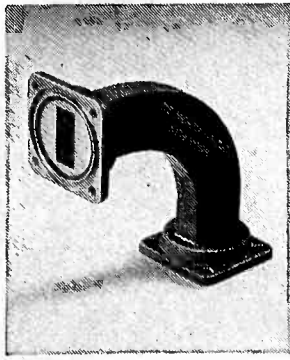

90° Elbow (H Plane) DB-433

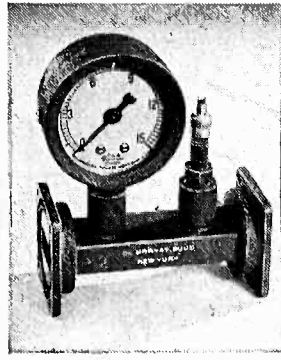

Pressurizing Unit DB-452

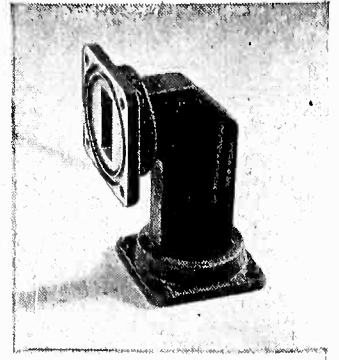

Mitered Elbow (H Plane) DB-439

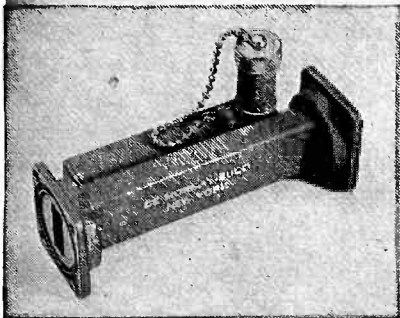

Uni-directional Broad Band Coupler DB-442

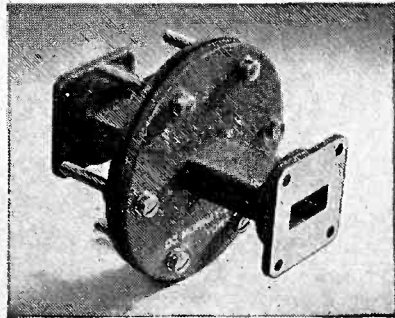

Bulkhead Flange DB-451

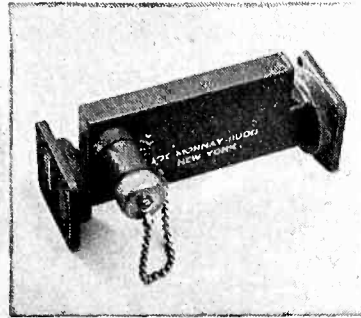

Uni-directional Narrow Band Coupler DB-440

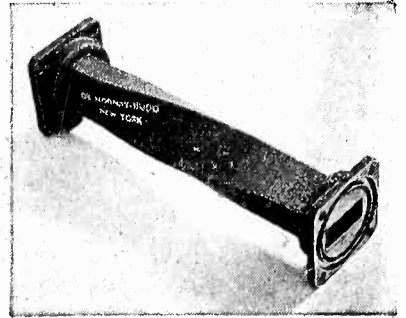

90° Twist DB-435

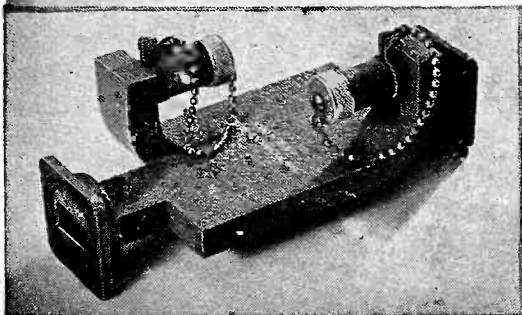

Bi-directional Narrow Band Coupler DB-441

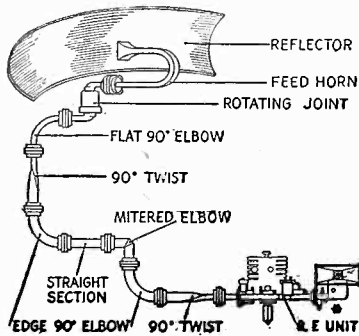

Typical wave guide assembly illustrating use of De Mornay-Budd components available from standard stocks.

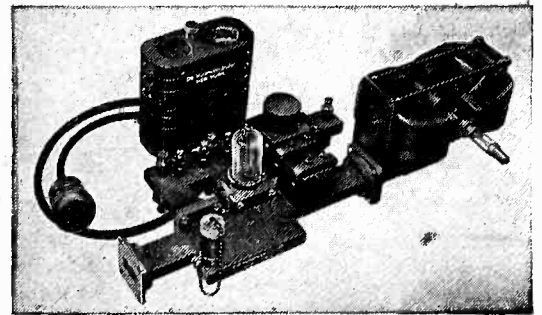

RF Radar Assembly DB-412

When you use any De Mornay-Budd wave guide assembly, you know exactly how each component will function electrically. You avoid possible losses in operating efficiency through impedance mismatches, or breakdown and arcing caused by a high standing wave ratio. (See chart below.)

De Mornay-Budd wave guides are manufactured from special precision tubing, and to the

most stringent mechanical specifications. Rigid inspection and quality control insure optimum performance

NOTE: Write for complete catalog of De Mornay-Budd Standard Components and Standard Bench Test Equipment. Be sure to have a copy in your reference files. Write for it today.

The curve shows the manner in which the reflected power increases with an increase in the voltage standing wave ratio. The curve is calculated from the following equation:

$$\% \text{ Power Reflected} = \left(\frac{\left(\frac{V_{\max}}{V_{\min}} \right) - 1}{\left(\frac{V_{\max}}{V_{\min}} \right) + 1} \right)^2$$

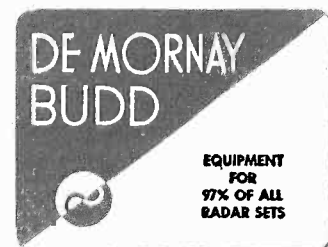
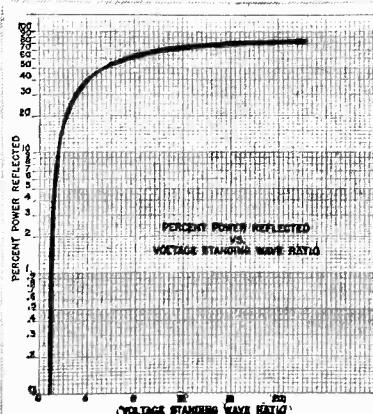

De Mornay-Budd, Inc., 475 Grand Concourse, New York 51, N. Y.

third harmonic. Air trimmers are used on all bands. Calibration is stable and accurate to 0.5 percent up to 1,600 kc and 1 percent on higher frequencies. The buffer stage is modulated by an internal 400-cycle generator providing pure sine wave modulation (less than 5 percent distortion) as well as an audio signal for external testing purposes. The instrument can also be modulated by an external variable audio oscillator.

Sensitive Relay (11)

WARD LEONARD ELECTRIC Co., Mount Vernon, N. Y. The new Bulletin 108 sensitive relay is a plug-in type mounted on a standard octal plug base and enclosed in a cylindrical metal can hermetically sealed.

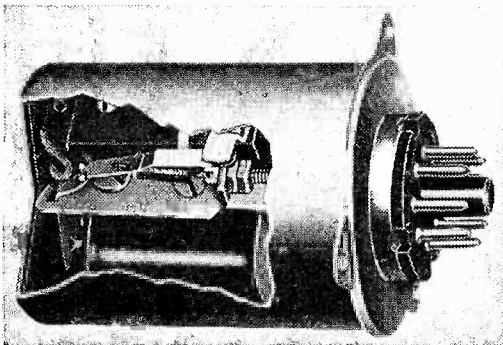

The relay is provided with a normally open single-pole contact having ratings of 2 amperes 24 volts a-c or d-c, 0.75 ampere 125 volts d-c and 2 amperes 125 volts a-c. The a-c ratings are for noninductive loads at commercial frequencies. Average coil consumption is 0.056 watt so that the relays are suitable for current-sensitive applications from 1.3 milliamperes to 0.54 ampere on direct current and are applicable for operation on nominal voltages from 0.1 to 48 volts d-c.

Variable Frequency Stimulator (12)

RAHM INSTRUMENTS, Inc., 12 West Broadway, New York 7, N. Y. A new electrophysical stimulator supplies frequencies in the range of 11.5 to 1,300 cycles per second in either sawtooth or sharp pulse shape. Maximum output of 10 volts is available with continuously variable output adjustable within 2 millivolts. Good frequency stability for line voltages from 95 to 125

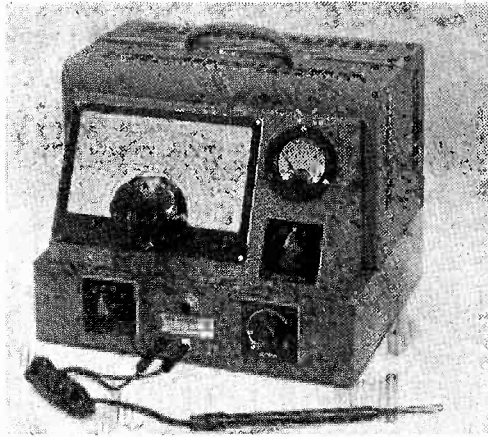

volts is obtained by use of a regulated voltage supply for the oscillator section.

Breakdown Tester (13)

SUPERIOR ELECTRIC Co., 377 Church St., Bristol, Conn. To conform to ASTM specifications, the output voltage of dielectric break-down testers must be increased at a uniform rate. The Hypot Auxiliary has been designed to operate as an intermediary between a 35-kv oil tester and a 115-volt single-phase source. The basic element is a

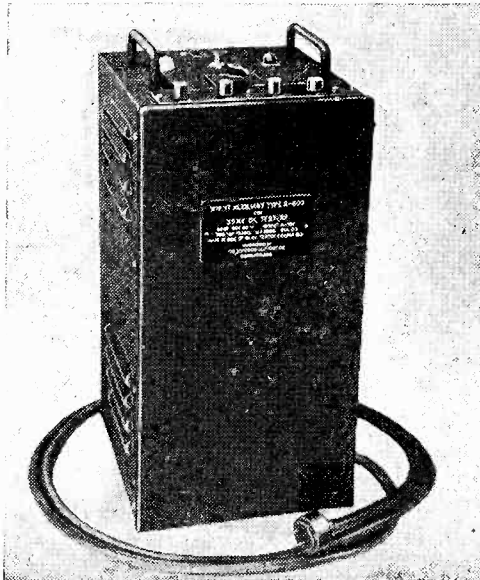

powerstat variable transformer driven by a synchronous fast starting and stopping motor. Various switching arrangements enable the Hypot Auxiliary to be completely automatic or semiautomatic. Colored signal lights provide effective means of determining the operations of the unit.

Counter Set (14)

HERBACH AND RADEMAN Co., 517 Ludlow St., Philadelphia 6, Pa. The GL532C high speed counter set con-

sists of a preamplifier, second amplifier, power supplies, including a high voltage supply for a Geiger-Muller tube, and scaling circuits arranged for connection to recorder circuits. The equipment uses 28

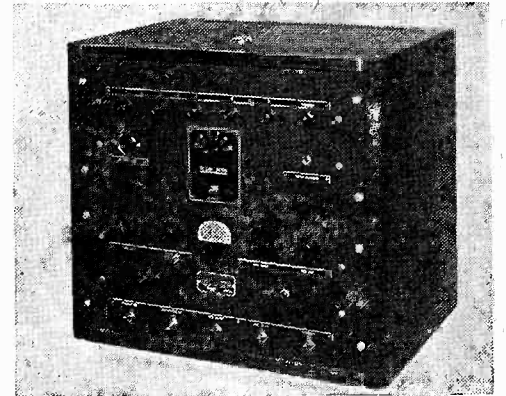

tubes and will record a maximum speed of 160 counts a second for radi-active substances at an accuracy of 5 percent using a commercial impulse register. Other arrangements will result in an increased counting speed. Further details are given in a bulletin.

Spot Frequency Generator (15)

ELECTRONIC MFG., Co., 714 Race St., Harrisburg, Pa. The model No. 200 generator provides 12 preset frequencies from 175 kc to 20 mc any of which can be switched to the output jack. Any of the radio fre-

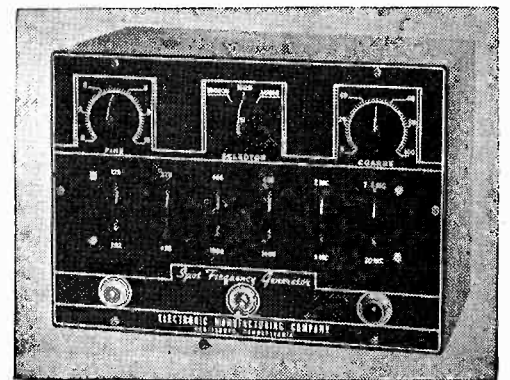

quency signals most useful for broadcast receiver testing can be modulated by a 400-cycle tone furnished in the unit. Good shielding allows the attenuator to be set for an output of less than 1 microvolt.

Hermetic Seals (16)

HERMETIC SEAL PRODUCTS Co., 414 Morris Ave., Newark 3, N. J. Hermetic-Glass headers possess a matched coefficient of expansion; (continued on p 218)

SPRING LOCK NUT

REVOLUTIONARY NEW FASTENER

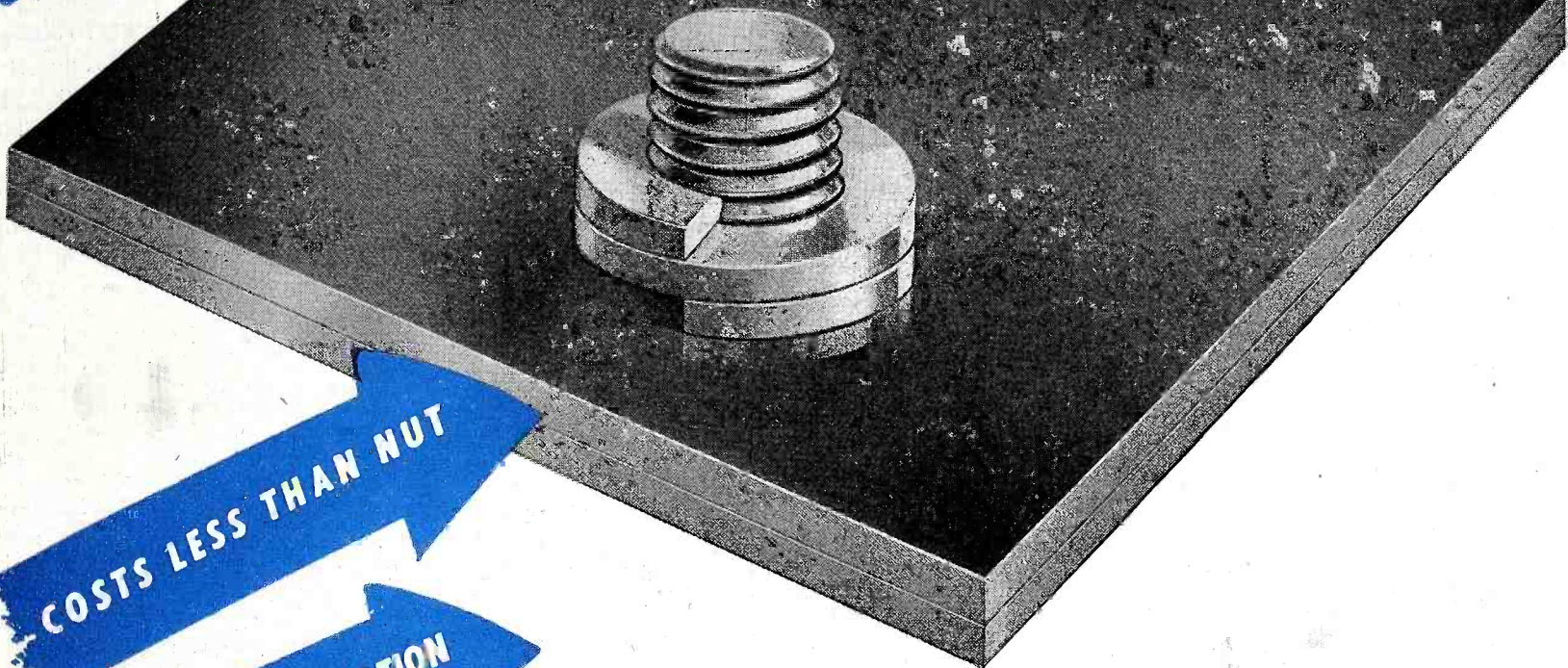

- COSTS LESS THAN NUT
- ELIMINATES ONE OPERATION
- SURE LOCK FOR BOLT
- SPEEDS PRODUCTION
- EASILY ASSEMBLED

CUTS TIME . . . MATERIAL . . . COSTS

Here's one of the greatest advancements ever made in the field of fastening devices. A new and revolutionary fastening device developed in the engineering and research laboratories of Garrett's to meet an urgent post-war need.

It replaces the conventional nut and in one assembly operation assures a positive locking action on the bolt. The Diamond G Spring Nut has all the advantages of a regular nut and is adaptable for use in "hopper-feeders" and various types of power wrenches. Because of precision manufacturing it has greater gripping power on threads of screw or bolt and therefore resists loosening. This new Spring-Nut is priced to offer a tremendous saving over conventional nuts and other fastening devices.

Don't delay . . . get your information on this new development of Garrett's today. Write for complete information and prices on the Diamond G Spring-Nut, or just call your local Garrett office and have the Diamond G man show you how you can save with Spring-Nut on your products.

GEORGE K. GARRETT CO., INC.
1421 CHESTNUT ST., PHILADELPHIA



DIAMOND  **PRODUCTS**

LOCK WASHERS • FLAT WASHERS • STAMPINGS • SPRINGS • HOSE CLAMPS • SNAP AND RETAINER RINGS

NEWS OF THE INDUSTRY

Edited by JOHN MARKUS

Spring technical meetings; Eta Kappa Nu awards resumed; Geiger-Muller counter laboratory established; engineer promotions

International Conference on Radio Aids to Navigation

U. S. MANUFACTURERS of electronic equipment for marine navigation will show their products to representatives of 60 countries at an international session sponsored by the State Department in New York City and New London, Connecticut April 28 to May 9.

The purpose of the meetings is to exhibit equipment such as loran and radar, already adopted by this country, and to discuss various technical problems and policies working towards possible standardization of certain radio navigation aids at some later meetings.

These conferences are a return engagement on a larger scale for meetings held in London in May 1946, at which time British equipment was displayed to representatives of the U.S., the Dominion, and European countries.

According to present plans, the first week's meetings at Hotel Roosevelt, New York City will be

devoted to the presentation of about 30 technical papers, technical discussions, and exhibits of equipment. The group will move to New London for the second week to see actual tests of equipment on three vessels—a coast guard cutter, a maritime service training vessel, and a coast and geodetic survey vessel.

About 250 to 300 delegates and technical advisors are expected to attend the meetings, which are being held just previous to the World Telecommunications Conference starting May 15 at Atlantic City.

Chicago Parts Show

WITH ALL exhibit space assigned and heavy advance registration already in, sponsors of the Radio Parts and Electronic Equipment Show predict record attendance at the Hotel Stevens, Chicago, for this year's show. Monday May 12 will

be National Electronic Distributors Association day, with a breakfast for manufacturer guests of NEDA members and a lunch for the sponsoring organizations (RMA, Sales Managers Club Eastern Division, Association of Electronic Parts and Equipment Manufacturers, and NEDA). The exhibition hall will be open on May 13, 14, and 15 for member exhibitors, booth attendants, members of the press, sales representatives, and distributors only. Radio amateurs and the general public will be admitted only on Friday May 16, which is open house day.

Research Evaluation Committees

THE RECENTLY established Joint Research and Development Board under the direction of Dr. Vannevar Bush has organized a number of technical committees to study existing Army and Navy research projects. The object is to determine means of increasing the effectiveness of the research and development programs and eventually to redistribute some of the work if it is considered advisable.

The committees will function first in an advisory capacity. However, it is expected that they will increase in power, and that some military projects may be reevaluated.

The committee on electronics is headed by Dr. J. A. Stratton, director of the Research Laboratory of Electronics at MIT, and will have such special panels as radar, communications, and countermeasures. Other committee heads are: Atomic Energy—Dr. J. B. Conant, president of Harvard University; Guided Missiles—Dr. Karl T. Compton, president of MIT; Geophysical Sciences—Dr. Roland F. Beers, president, Geotechnical Corporation, Dallas, Texas; Geographical Exploration—Dr. Charles H. Behre, Jr., professor of geology, Columbia University.

MANEUVERABLE ROCKET-POWERED MISSILE

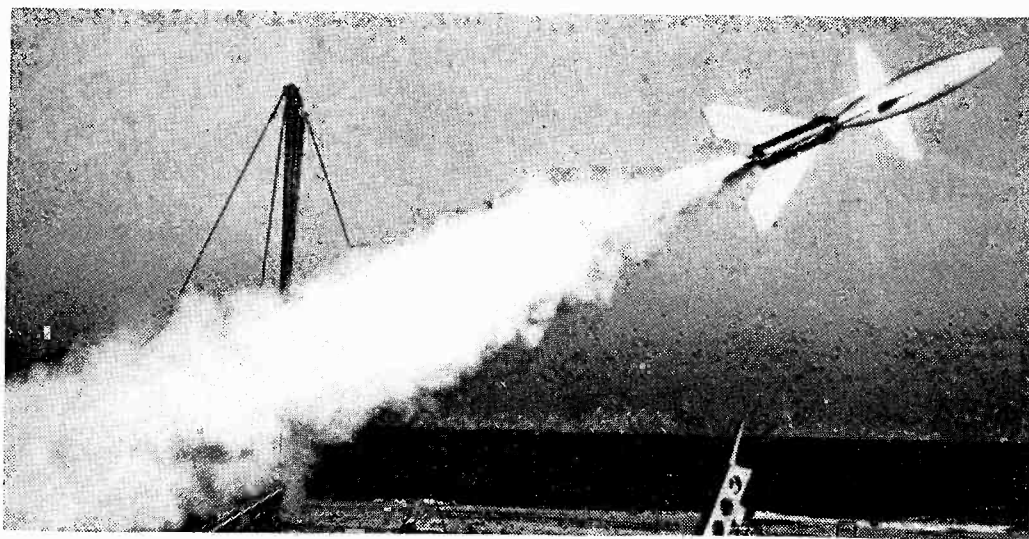

Newest guided missile to be announced is the Tiamat, named after an Assyrian-Babylonian goddess whose emblem was a winged dragon. It is the first to be flown successfully through a predetermined program of maneuvers. Weight is 600 lb, length is 14 ft, and top speed is 600 mph. Instrumentation readings in the rocket are telemetered to the ground over a radio link, and the missile is tracked by radar during flight. Picture shows takeoff from launching platform at NACA Laboratory, Langley Field, Va.

Fellowships in Electronics

A NUMBER of graduate and advanced research fellowships are of-

(Continued on p 260)

ELECTRONIC EQUIPMENT

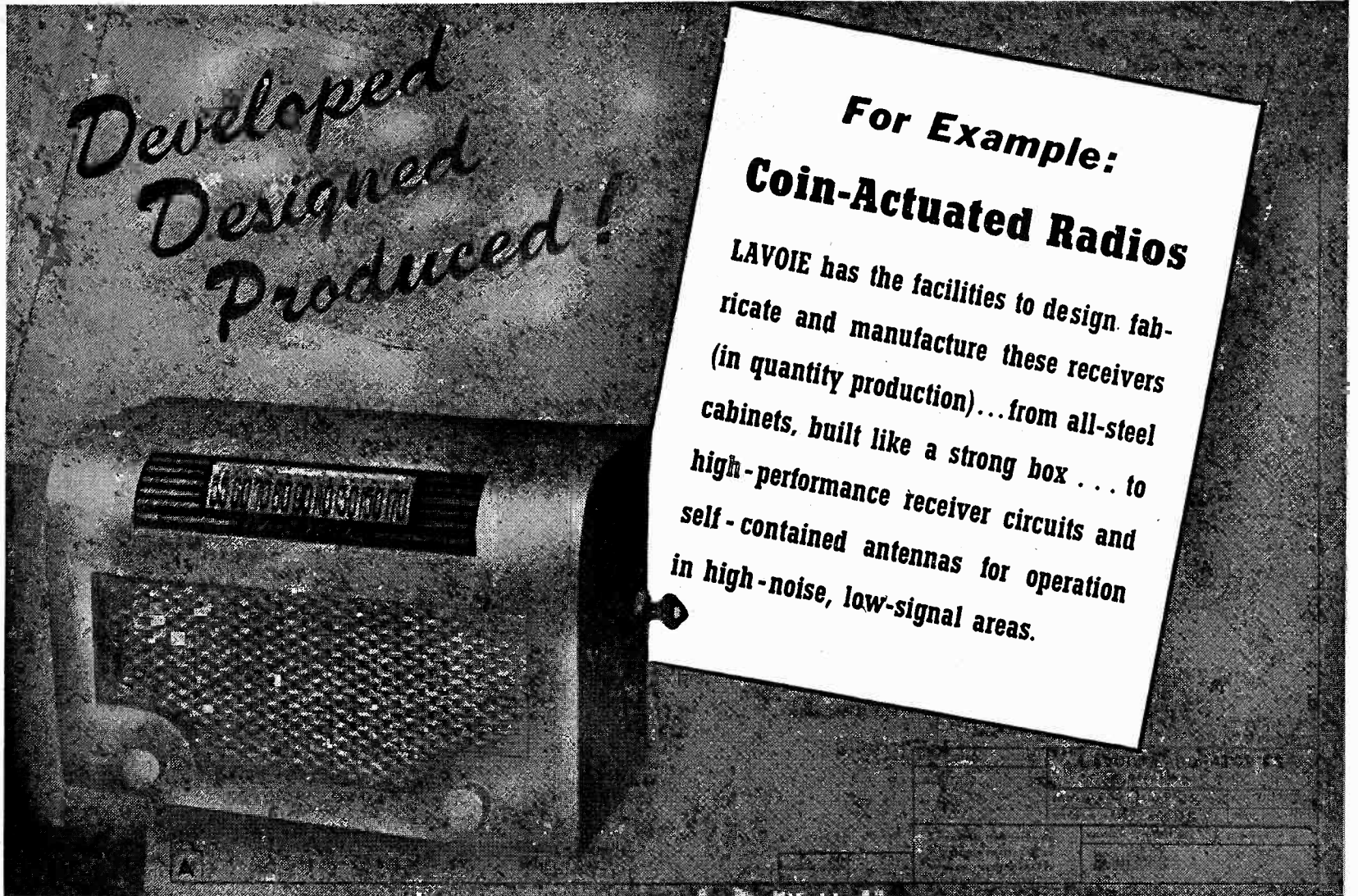

LIKE the typical example above, LAVOIE LABORATORIES have the technical skill, the plant facilities and the "know how" to carry through from a basic idea or rough sketch to finished product. Furthermore, as specialists you are assured of precision work and **LOW** unit costs based on hard, practical experience . . . Whether you are interested in limited quantities or mass production, we shall be glad to consult or quote without cost or obligation.

**FREQUENCY STANDARDS • FREQUENCY METERS • RECEIVERS
TRANSMITTERS • ANTENNAS and MOUNTS**



Lavoie Laboratories

RADIO ENGINEERS AND MANUFACTURERS
MORGANVILLE, N. J.

Specialists in the Development and Manufacture of UHF Equipment

MANUFACTURERS

WHOLESALERS

JOBBERS



**MANUFACTURERS
WHOLESALERS
JOBBERS . . .**

to obtain this desirable material get in touch with your WAA approved Distributor!

Much of the huge inventory of electronic tubes and equipment, declared surplus by the armed forces, has been allocated to approved distributors for disposal.

The names and addresses of our distributors are listed here. They are equipped to serve your needs and will know what is immediately available.

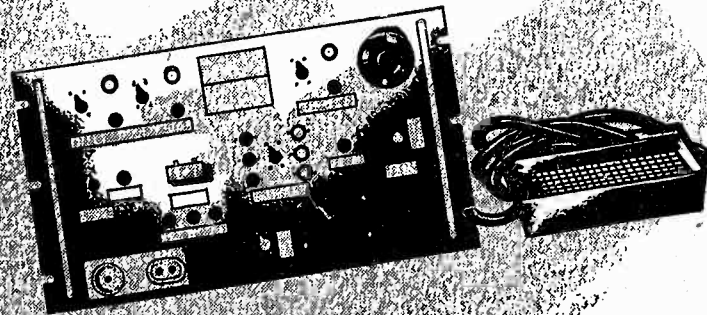
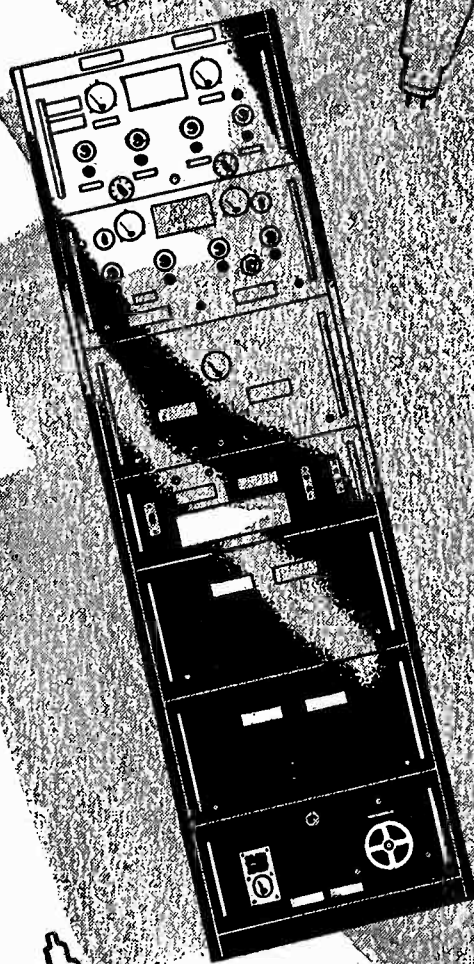

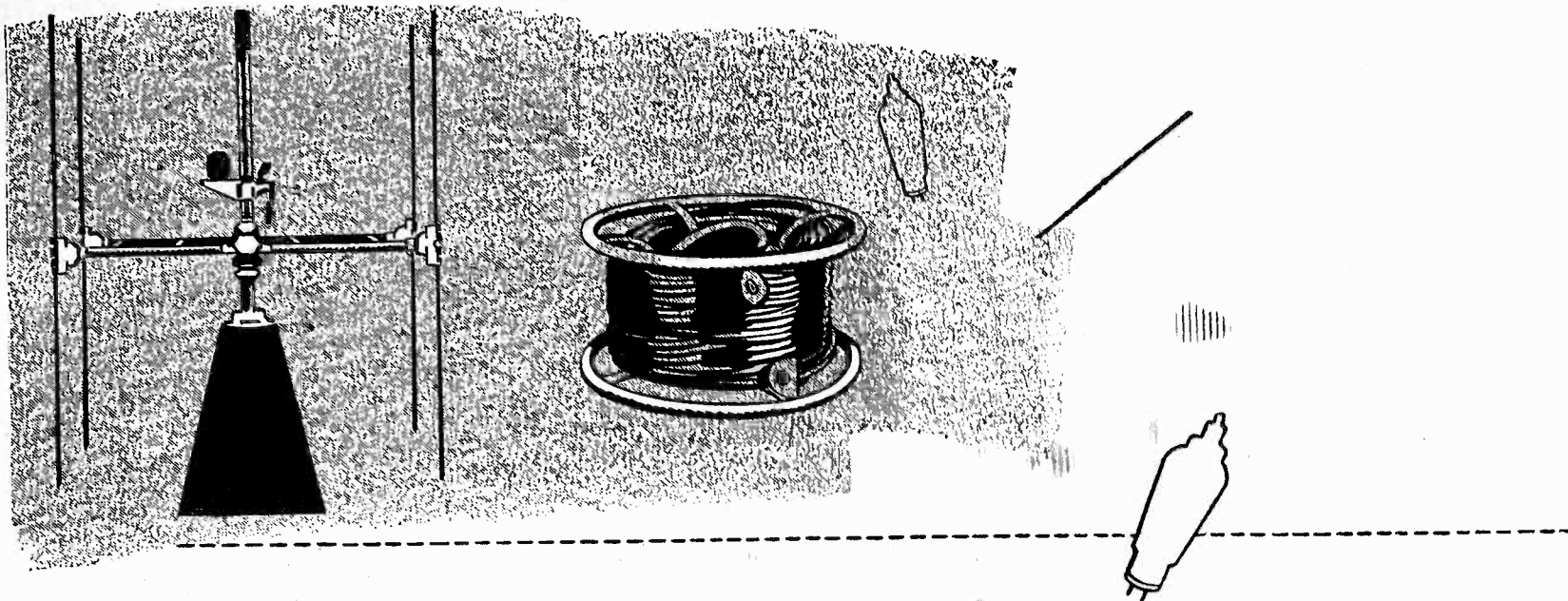

**THESE ARE THE APPROVED DISTRIBUTORS APPOINTED
BY THE WAR ASSETS ADMINISTRATION TO SERVE YOU:**

American Condenser Co.
4410 Ravenswood Avenue
Chicago 11, Illinois

Automatic Radio Mfg. Co., Inc.
122 Brookline Avenue
Boston 15, Massachusetts

Belmont Radio Corporation
3633 So. Racine Avenue
Chicago 9, Illinois

Communication Measurements Laboratory
120 Greenwich Street
New York 6, New York

Cole Instrument Co.
1320 So. Grand Ave.
Los Angeles, California

Electronic Corporation of America
353 West 48th Street
New York 19, New York

Electro-Voice, Inc.
Carroll & Cecil Streets
Buchanan, Michigan

Emerson Radio & Phonograph Corporation
76 Ninth Avenue
New York 11, New York

Essex Wire Corporation
1601 Wall Street
Ft. Wayne 6, Indiana

General Electric Company
Building 267-1 River Road
Schenectady 5, New York

Raytheon Manufacturing Company
60 East 42nd Street
New York 17, N. Y.

Smith-Meeker Engineering Company
125 Barclay Street
New York 7, New York

Southern Electronic Company
512 St. Charles Street
New Orleans 12, Louisiana

Standard Arcturus Corporation
99 Sussex Avenue
Newark, New Jersey

Sylvania Electric Products, Inc.
Emporium, Pennsylvania

Technical Apparatus Company
165 Washington Street
Boston 8, Massachusetts

Tobe Deutschmann Corporation
863 Washington Street
Canton, Massachusetts

Tung-Sol Lamp Works, Inc.
95 Eighth Avenue
Newark 4, New Jersey

General Electronics Inc.
1819 Broadway
New York 23, New York

Hammarlund Mfg. Company, Inc.
460 West 34th Street
New York 1, New York

Hoffman Radio Corporation
3761 South Hill Street
Los Angeles 7, California

Hytron Radio & Electronics Corporation
76 LaFayette Street
Salem, Massachusetts

E. F. Johnson Company
206 Second Avenue, S. W.
Waseca, Minnesota

Majestic Radio & Television Corporation
125 West Ohio Street
Chicago 10, Illinois

National Union Radio Corporation
57 State Street
Newark 2, New Jersey

Navigation Instrument Co., Inc.
2007 Capitol Avenue
Houston 3, Texas

Newark Electric Co., Inc.
242 West 55th Street
New York 19, New York

Radio Parts Distributing Company
128 W. Olney Road
Norfolk 10, Virginia

ELECTRONICS DIVISION

WAR ASSETS ADMINISTRATION



Offices located at: Atlanta • Birmingham • Boston • Charlotte • Chicago • Cincinnati • Cleveland • Dallas
Denver • Detroit • Fort Worth • Helena • Houston • Jacksonville • Kansas City, Mo. • Little Rock • Los
Angeles • Louisville • Minneapolis • Nashville • New Orleans • New York • Omaha • Philadelphia • Port-
land, Ore. • Richmond • St. Louis • Salt Lake City • San Antonio • San Francisco • Seattle • Spokane • Tulsa

1000

Need Fastenings?

See **SCOVILL!**

FOR SEMS WASHER SCREW ASSEMBLIES

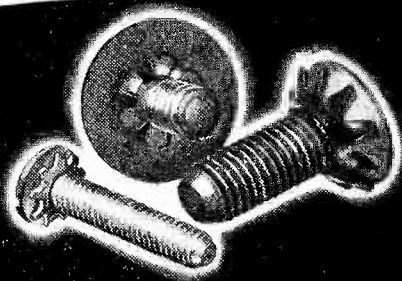

Washer permanently fastened on, yet free to rotate. Easier, faster driving. No fumbled, lost or forgotten washers. Matching finish on both parts. Easier ordering and balanced inventories.

FOR PHILLIPS RECESSED HEAD SCREWS

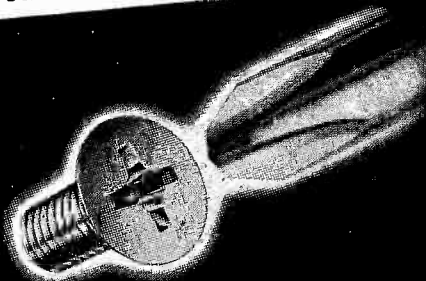

Increase assembly speed up to 50%! Cut down injuries to workers with no burrs, no skids. Reduce production costs. Reduce rejects! Improve product appearance! Go modern with Phillips!

FOR CLUTCH-HEAD SCREWS

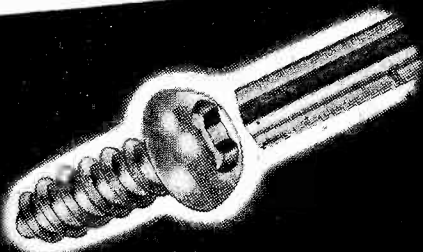

The latest type recessed-head screw. Screw locks on driver. Can't fall off. No screw-driver slippage. Easy to assemble. Exceptional driver life. Ordinary screw-driver may also be used.

FOR SPECIAL COLD-FORGED FASTENINGS

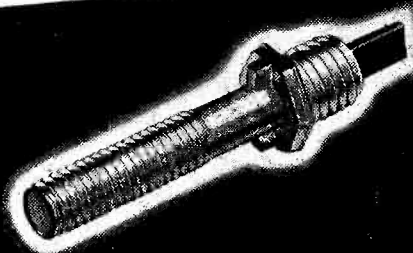

Scovill is expert in cold-forging unusual special fastenings, such as the one shown. Scovill designing ability, engineering skill, men and machines save money for customers. Consult Scovill!

Look at the fastenings you're now using—and see if they're the best for the job. Get better results—at less cost—with modern fastenings. If you use fastenings in *large quantities*, it will pay you to find out what Scovill can do for you. Fill out and mail the coupon below—now!

MAIL COUPON TODAY!



Scovill

QUALITY FASTENERS
FOR
QUANTITY CUSTOMERS

SCOVILL MANUFACTURING COMPANY
WATERVILLE SCREW PRODUCTS DIVISION
WATERVILLE 48, CONN. E-4

Please supply more information on:

- Scovill SEMS Washer Screw Assemblies
- Scovill PHILLIPS Recessed Head Screws
- Scovill CLUTCH HEAD Screws
- Scovill Special Cold-forged Fastenings

NAME _____

COMPANY _____

ADDRESS _____

TUBES AT WORK

(continued from p 148)

is unchanged. The remaining changes are the inclusion of an audio-frequency modulator and the substitution of the one-mc reference crystal by one of higher frequency of not less than five mc.

For modulated output, the 6SJ7 tube, formerly the r-f oscillator, is utilized. The audio-frequency oscillator components are mounted in the space originally occupied by the r-f components, and the frequency-band switch is used to turn the modulation on and off.

Operation

The method of using the modified instrument is essentially the same as that described in the instruction manual supplied with the standard instrument. A calibration book must be prepared showing the correct dial reading for at least every megacycle in the fundamental range. For this purpose, the use of a substandard frequency meter is required. The harmonic frequencies corresponding to twice, three, four, five and six times those in the fundamental range should be shown in the same book against the appropriate dial readings.

When the instrument is put into use, the oscillator frequency must first be corrected. Determine whether the frequency to be measured lies within the fundamental range or, if not, determine the fundamental frequency harmonically related to it. Next, decide which crystal harmonic is closest to this

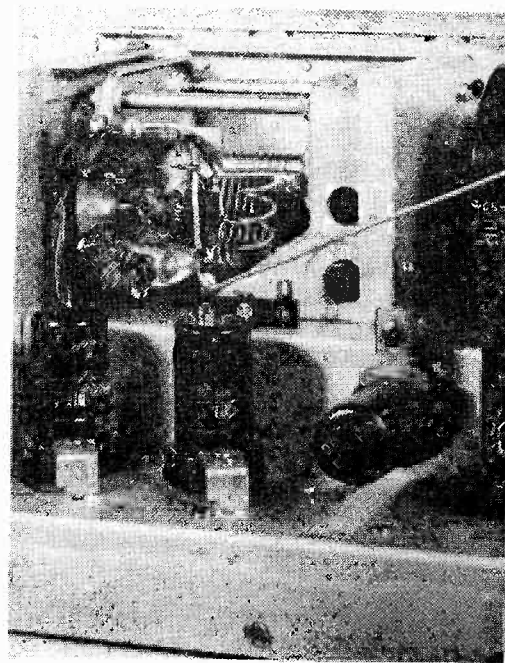

Mounting of the acorn tube and components. A 6,200-kc correction crystal is used in this model



IN adjusting itself to its greatly expanded postwar volume Formica has arranged and installed an entirely new department for the production of tubing, much more spacious, with modern high production machinery arranged for the most efficient straight line output.

That means beginning now we can take care very promptly of your tubing orders, no matter how large. You can also be sure of uniformity and high quality.

Electrical characteristics of Formica tubing have been much improved by recent developments in resinoids and by production techniques that have been affected by knowledge gained by the many special problems the Formica engineering department was called upon to solve during the war.



THE FORMICA INSULATION CO., 4661 SPRING GROVE AVENUE, CINCINNATI 32, OHIO

INTRODUCING THE NEW



"SIXTY"

CRYSTAL PICKUP CARTRIDGE

with the

"MUTED STYLUS"

Silent Tracking

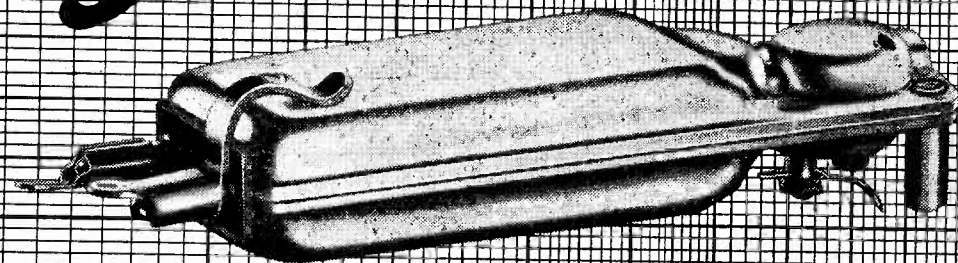

High Output

SPECIALLY DESIGNED TO REDUCE NEEDLE TALK

Here is a cartridge that is different—a smooth-working, soft-riding, silent-tracking cartridge especially designed to overcome problems of surface noise and distortion in home phonographs, coin-operated machines, and in all other applications where shellac and Vinylite pressings are used. The W60A tracks from an extremely low needle force of only 0.6 oz. to 1½ oz., yet has a 1.9 volt output. Special feature of the "SIXTY" is the protective guards for the semi-permanent-point needle, which is osmium or sapphire-tipped. High needle compliance coupled with low needle force give longer life to both needle and record. If you want to reduce distortion and needle talk, specify the "SIXTY". You'll notice the difference as soon as you listen to its "Proving" performance.

MODEL W60A (Sapphire) . . . CODE: RUSIS . . . \$7.50 List.

Patented by Shure Brothers and licensed under the Patents of the Brush Development Company

SHURE BROTHERS, INC.

Microphones and Acoustic Devices

225 West Huron Street, Chicago 10, Illinois

Cable Address: SHUREMICRO



TUBES AT WORK

(continued)

fundamental frequency and set the dial to the reading appropriate to it; then, with the switch at CHECK, a beat note should be heard. Adjust the correcting capacitor C_2 to zero beat and switch to OPERATE.

To determine the frequency of a transmitter, rotate the dial until zero beat with the signal to be measured is obtained; read the dial, and convert it to a frequency by interpolating between the two nearest readings in the calibration book, multiplying by the harmonic order if appropriate.

To tune a receiver, determine the correct dial setting for the frequency meter by interpolation between the two nearest calibration book readings, adjust the dial to the reading so obtained, and the appropriate fundamental and harmonic frequencies will be available at the antenna terminal. If the receiver has no c-w oscillator, the switch on the instrument previously used for frequency-band selection is set at LOW to obtain a modulated signal.

Two-Way Teletype In Air

TELETYPE METHODS of communication can be extended to aircraft in flight by use of equipment developed by Teletype Corporation engineers and Bell Telephone Laboratories. Radio-telephone facilities provided for plane to ground communication are used without modification.

For interconnecting a teletype machine and existing press-to-talk radio telephone equipment, a converter is used. This translates the electrical conditions set up by the teletypewriter keyboard into signals suitable for transmission over the radio telephone channel. When receiving, it translates the signals from the radio channel into signals suitable for operating a teletypewriter.

The unit also automatically conditions the radio equipment for transmission when the first teletype character is sent, automatically returns the radio equipment to a receiving condition after the last teletype character is sent and lights indicator lamps to show whether the radio circuit is in the transmitting or receiving condition.

The converter unit produces an

LET *Speed Nuts*^{*} PUSH DOWN

Your Assembly Costs...

To Restore Normal Earnings

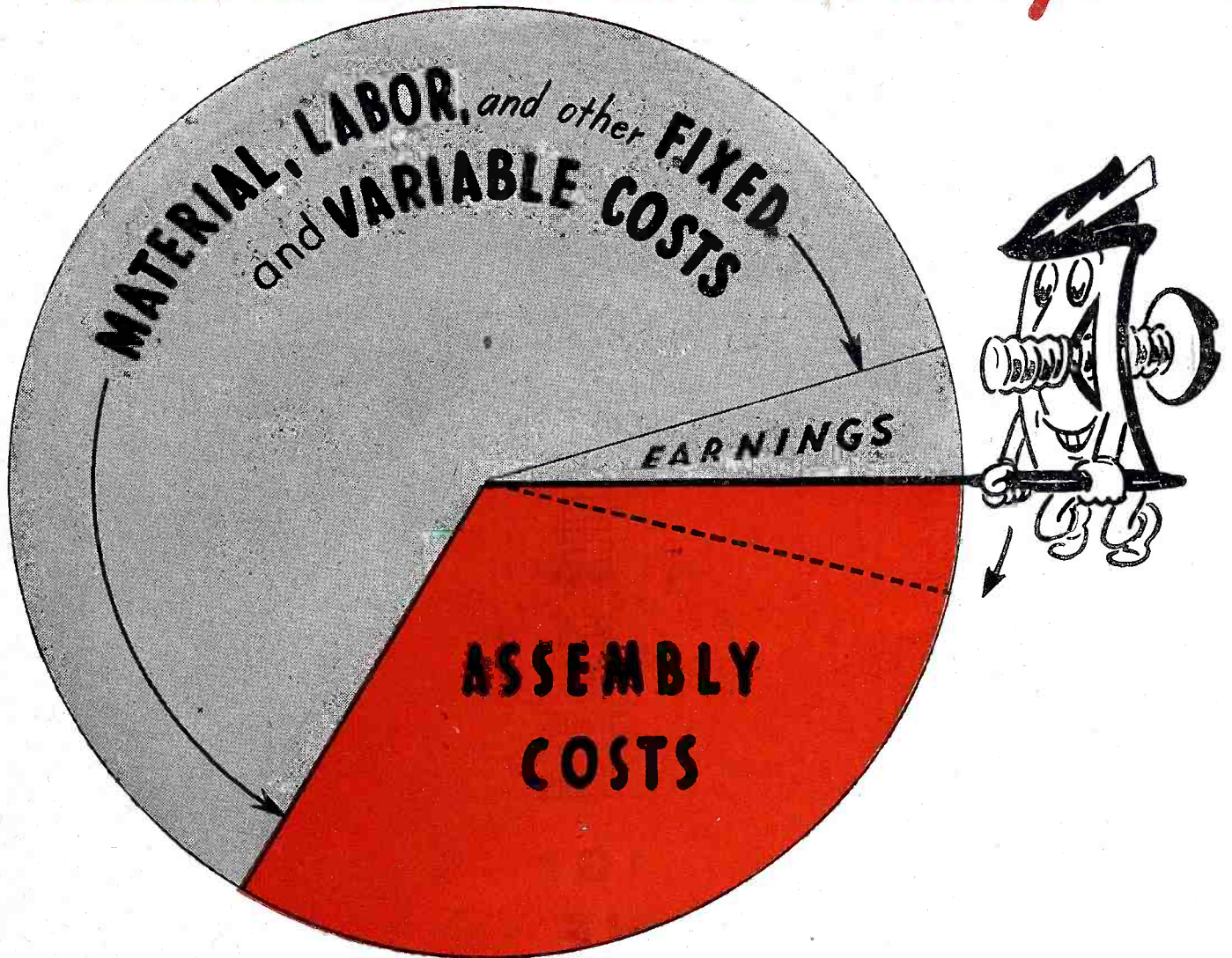

In building most any product, of metal wood or plastic, the most flexible cost factor is assembly. While reductions in other costs are difficult at best, your really big item of ASSEMBLY COST can be pushed down drastically.

And you can do it NOW. Hundreds of the nation's leading manufacturers are already doing it to restore normal earnings and meet the coming competition.

The SPEED NUT SYSTEM of Spring Tension

TINNERMAN PRODUCTS, INC.

In Canada: Wallace Barnes Co., Ltd., Hamilton, Ontario
In England: Simmonds Aerocessories, Ltd., London

Fastenings is doing cost-saving jobs that may surprise you when you see the details. Over 4,000 shapes and sizes are available for the solution of your particular fastening problems.

If you want to truly modernize your entire assembly methods, to assure fair profits, investigate what the SPEED NUT brand of fasteners can actually do for you NOW. First step is to send assembly details for a complete no-charge fastening analysis.

2106 FULTON ROAD

CLEVELAND, OHIO

In France: Aerocessoires Simmonds, S.A., Paris
In Australia: Aerocessories, Pty. Ltd., Melbourne

Speed

MORE THAN 4000



Nuts^{*}

PATENTED

* Trade Mark Reg. U. S. Pat. Off.

SHAPES AND SIZES

F A S T E S T T H I N G I N F A S T E N I N G S



since 1935
the only VOLT METER
featuring a simplified
LOGARITHMIC SCALE

10 MICROVOLTS
to 100 VOLTS

with the

BALLANTINE ELECTRONIC VOLT METER and DECADE AMPLIFIER

THIS ENORMOUS RANGE OF VOLTAGES—ten million to one—is accurately covered by the Model 300 Electronic Voltmeter and Model 220 Decade Amplifier illustrated above. Frequency range 10 cycles to 150 kilocycles. Accuracy 2% at any point on the scale. Five decade ranges with logarithmic scale indication make Voltmeter readings especially easy. Model 300 Voltmeter (AC operated) reads from .001 to 100 volts and Model 220 Amplifier (battery operated) supplies accurately standardized gains of 10x and 100x. Permanent calibration unaffected by fluctuations in line voltage, or variation in tube characteristics, circuit constants, etc.

Descriptive bulletin available

BALLANTINE LABORATORIES, INC.
BOONTON, NEW JERSEY, U. S. A.

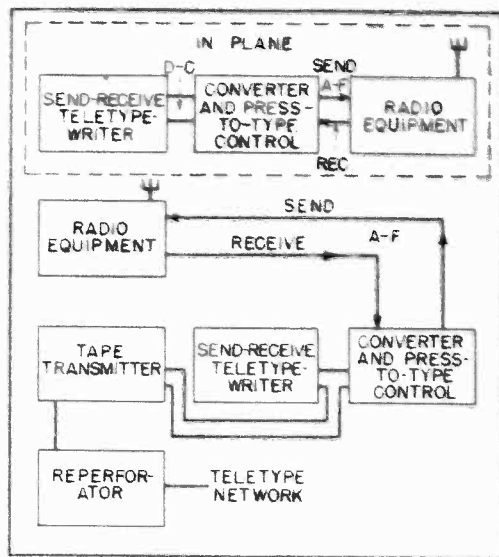

Block diagram of teletype system for plane to ground operation

audio-frequency signal which modulates the radio transmitter continuously during teletype transmission. The frequency of the audio signal is varied back and forth between the frequencies of 1,615 cycles and 1,275 cycles in accordance with the teletype character being transmitted. This frequency-shift transmission has an advantage in signal-to-noise ratio over on-off keying of a single tone. Another important characteristic of the frequency-shift method is rapid and accurate compensation for changes in amplitude of the signal received over the radio circuit. For this reason no adjustments need be made during operation.

Approximately five seconds after the automatic transmission is stopped a red indicator lamp is turned off to show that the control circuits have restored the radio equipment to a receiving condition. Additional control circuits in the converter then place an electrical holding condition on the teletype unit so that it will not be operated falsely by noise received on the radio circuit in the absence of a signal.

At the beginning of each transmission a short preparatory signal is transmitted to release the holding condition which exists at all teletypewriters when no transmission or reception is taking place. This preparatory signal is supplied automatically when transmission is from perforated tape. When transmission is from the teletype keyboard a few nonprinting teletype characters are first transmitted.

After transmission from the

FRANKLIN ANNOUNCES

TWO NEW MINIATURE LAMINATED SOCKETS

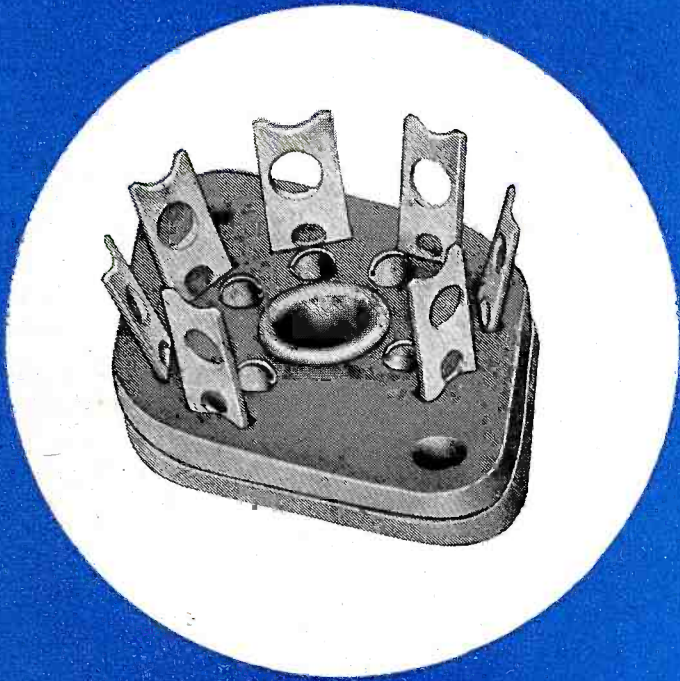

57 A 11 . . . for 1" between mounting centers
 57 A 12 . . . for 1-5/16" between mounting centers

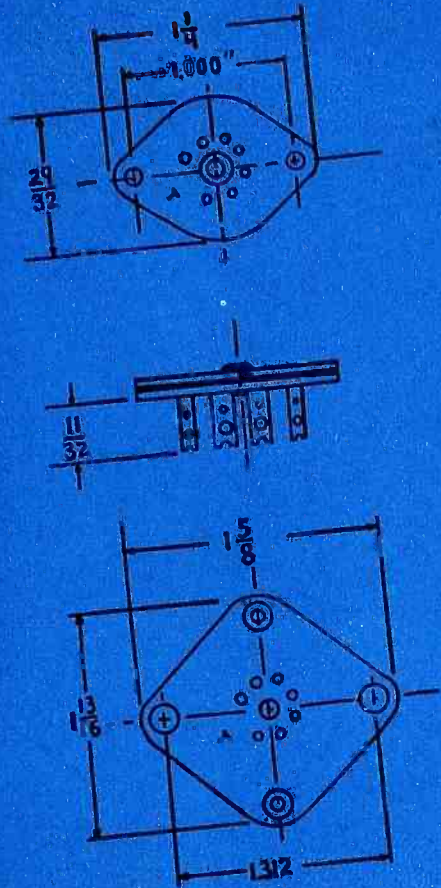

57 A 11 and 57 A 12 Miniature Laminated Sockets have spring type contacts that GRIP and hold the tube securely without the need for locking devices. These contacts, being longer and spaced wider apart, permit greater ease in soldering thus lower production costs. 57 A 12 is interchangeable with Octal Sockets of like mounting center enabling chassis design for use with either.

and for
TELEVISION
 the
DUO DECAL

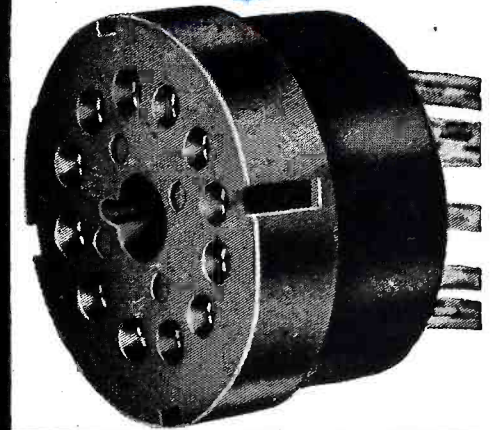

ELECTRONIC
 COMPONENTS



A.W. FRANKLIN MFG. CORP.

43-20 34th STREET • LONG ISLAND CITY 1, NEW YORK

SOCKETS • TERMINAL STRIPS • PLUGS • SWITCHES • PLASTIC FABRICATION • METAL STAMPINGS • ASSEMBLIES



QUIET...

No other word could so vividly . . . so adequately . . . describe the superb reproducing quality of Astatic's excitingly new, greatly improved "QT" Phonograph Pickup Cartridge. Now in production, this finer cartridge is being used extensively for new applications as well as modern home replacements.



(Pat. Applied For)

Jewel Tip

Precious Metal Tip

NEW TYPE "QT" CARTRIDGE

Highly acclaimed for its clear, clean, "quiet-talk" reproduction, the "QT" Cartridge is ideally suited for use with home record players. The unusual design of this cartridge with a needle allowing appreciably more vertical compliance has VASTLY reduced surface noise and needle talk for more enjoyable reproduction.

Made in Two Models

The "QT" Cartridge is available with either precious metal tipped needle, Model QT-M, or with jewel tip, Model QT-J. Both needles are REPLACEABLE, easily inserted or removed. MATCHED to the cartridge, they are the only needles that can be used with it, thus assuring that the quality of reproduction will remain constant regardless of needle replacement.

LITERATURE IS AVAILABLE

THE **Astatic** CORPORATION
 CONNEAUT, OHIO
IN CANADA CANADIAN ASTATIC LTD, TORONTO, ONTARIO

©Astatic

Astatic Crystal Devices Manufactured under Brush Development Co. patents.

sending station has ceased, the radio teletype circuit goes into the idle or waiting condition, and then when another station on the network begins transmission, it is actuated to the receiving condition, as indicated by illumination of a green indicator on the converter-control unit.

Messages may be transmitted easily and accurately by personnel such as the crew chief or plane hostess who are not experienced in radio operation.

By connecting a reperforator in the plane-ground communication circuit at the ground station, passenger message traffic may be retransmitted over commercial telegraph circuits without the necessity for retyping. Similarly a reperforator associated with the commercial land line circuit would provide messages in perforated tape form for transmission to the plane at such times as do not interfere with communications necessary to the operation of the plane.

Measuring High Potentials

BY MORTON R. WHITMAN

*Electronic Engineer
 Thordarson Electric
 Chicago, Illinois*

A TECHNIQUE FOR measuring high d-c potentials has been effectively employed in this laboratory. Where a laboratory already possesses a continuously variable high-voltage d-c supply, no additional investment in cumbersome and expensive strings of wire-wound resistors is required.

As may be seen from the diagram, the method uses a second high-voltage supply together with the one to be measured in a potentiometer circuit. The advantage of this technique is that at balance no measuring current drain is imposed on the test circuit. This means that supplies having a large effective internal impedance can be readily measured without regard to the consequent regulation.

As an illustration, take the case of a 30-kv supply with load current of 200 microamperes. The equivalent load resistance would be 150 megohms—an awkward value for a meter multiplier. This setup is additionally useful for measuring small increments in large voltages.

The meter should be of high

TRUARC rings lock piston pins securely for drilling engine on 24-hour service

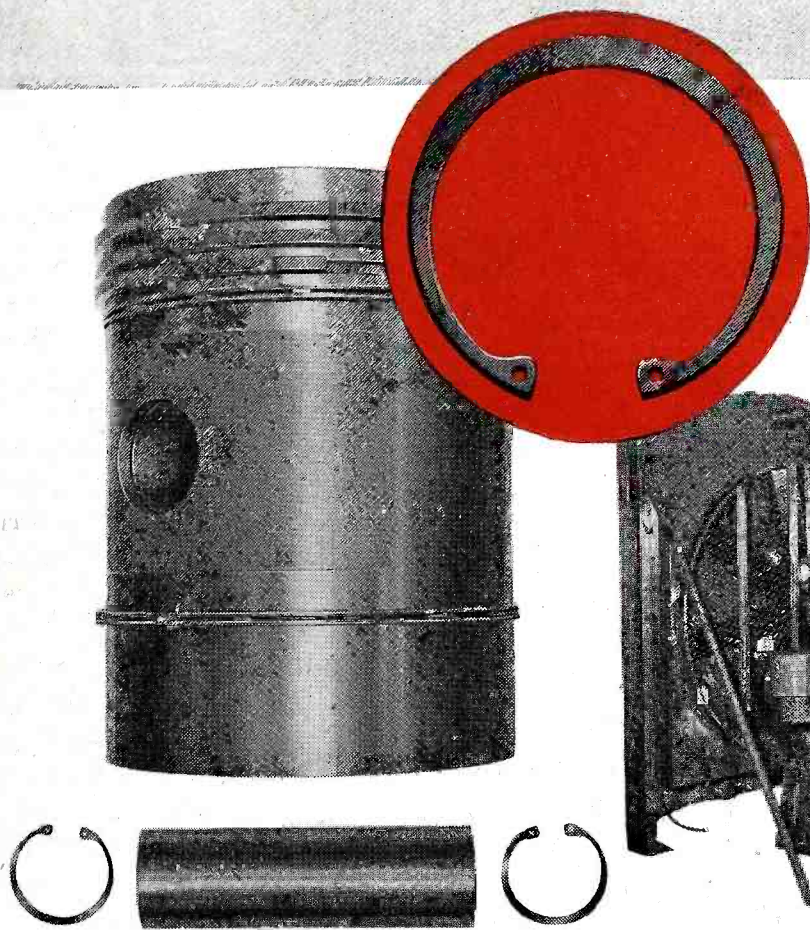

- cut costly shutdown time
- ease dis-assembly, re-assembly
- stay intact under frequent removal and re-use

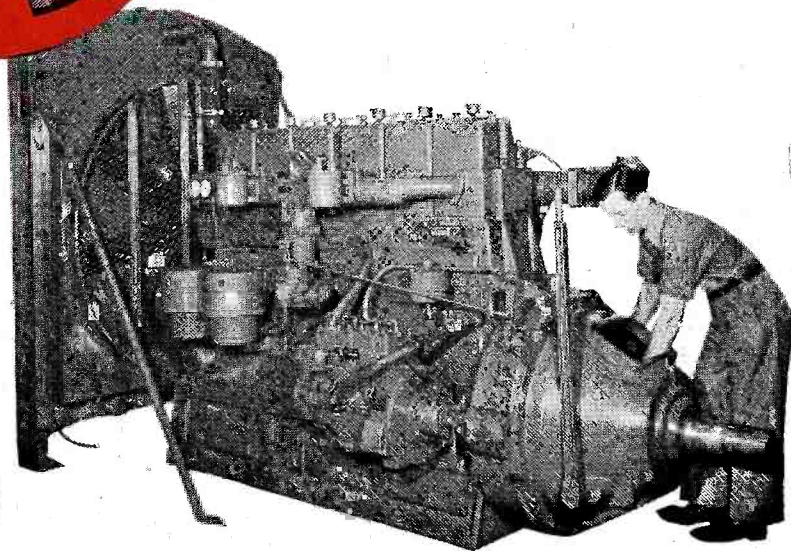

After changing to Waldes Truarc Retaining Rings for piston pin retainers in their powerful new Superior 6G-510 oil-field drilling engine, the Superior Engine Division of The National Supply Company finds field maintenance greatly simplified.

Truarc Rings can be easily removed and replaced in a few seconds. They retain both concentricity and flexibility without regard to the number of times they are handled. Other piston pin retainers take a permanent set, delay field repairs, pile up costs.

On rocker arms and pumps, on crankshafts and plungers, on a wide variety of applications, Truarc Rings do a better job of holding moving parts together. Designers, production and maintenance men in many industries find Truarc cuts costs sharply wherever used. Its never-failing grip is a superior solution to fastening problems. Its patented design assures constant circularity under all conditions. Send us your drawings: Waldes Truarc engineers will be glad to show how Truarc can help you.

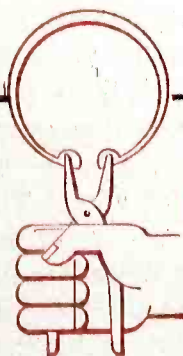

WALDES
TRUARC
U. S. PATENT RE. 18,144
RETAINING RINGS

WALDES KOHINOOR, INC., LONG ISLAND CITY 1, NEW YORK

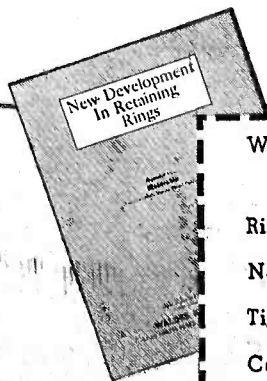

Send for new Truarc booklet,
"New Development In Retaining Rings"

Waldes Kohinoor, Inc., 47-10 Austel Place 18-M
Long Island City 1, N. Y.

Please send booklet, "New Development In Retaining Rings" to:

Name _____

Title _____

Company _____

Business Address _____

City _____ Zone _____ State _____

Seamless [PATENTED] RADIO PINS

DEVELOPED AND MANUFACTURED BY
THE AMERICAN BRASS COMPANY
WATERBURY BRASS GOODS BRANCH



Check the advantages...

These *seamless, patented* Radio Pins are uniform in size, with smooth surfaces for smooth operation. In staking, the ends roll over easily and without splitting. When molded into composition parts the closed end keeps out the molding compound.

If you use pins for vacuum tubes or adapters, fluorescent lights, plugs, or electrical equipment of any kind, the chances are you'll save time, money and rejections by using these seamless, patented Radio Pins. They are available in a wide variety of styles and sizes. Simply send a sketch, sample or description, with quantity, for quotation.

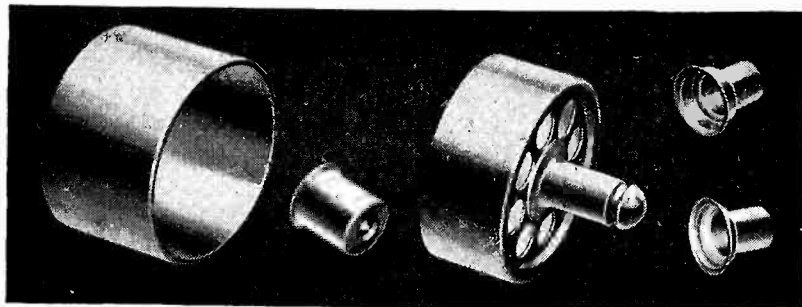

RADIO OR RADAR EQUIPMENT?

In addition to Radio Pins, we produce large quantities of top caps, base shells and adapter shells for vacuum tubes; also a wide variety of other metal products including deep drawn shells and cups, blanks and stampings, ferrules, grommets, washers, vents, fasteners—and the world's largest assortment of eyelets.

45406

THE AMERICAN BRASS COMPANY
WATERBURY BRASS GOODS BRANCH
WATERBURY 88, CONNECTICUT

TUBES AT WORK

(continued)

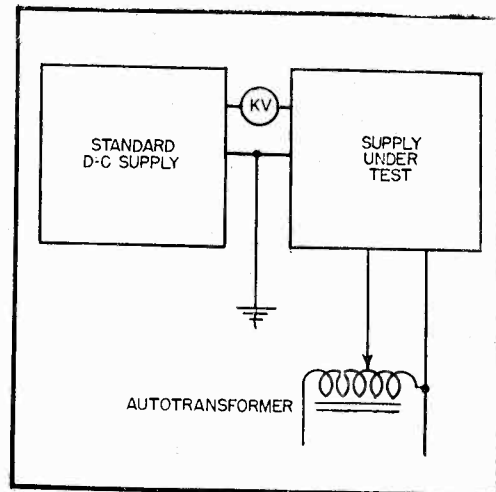

Simple circuit for measuring high potentials without consuming current from the supply under test

range, preferably 5 kilovolts. This is desirable since the supplies must be taken in alternate steps up to full value and surges due to gross movements of controls or transients may produce excessive voltages across the meter.

The procedure is to alternately raise each supply in sufficiently small steps so that the meter is not overloaded. When the test supply is at rated voltage, final adjustments should be made for zero deflection of the meter. At this point the voltage of both supplies is exactly equal.

Broadcast Carrier System

By F. R. BREWSTER

McGraw-Hill News Bureau
London, England

OVER 600,000 homes in Great Britain listen to broadcast relay companies, served by some 300 exchanges in towns with an aggregate population of between six and seven millions. Surveys have shown that, where such a system is available, one in every three householders chooses this form of listening; in some communities the density of subscribers is as high as 80 percent.

The original broadcast relay services carried a single program (received from the BBC by landline wherever possible) to subscribers at audio frequencies on a single pair of wires. Later, a second program was generally made available by adding a second pair of wires. The problem confronting the relay industry was how to increase the number of programs available while keeping to the absolute minimum the number of wires linking each subscriber to the network.

Carrier-frequency transmission

The Rauland VISITRON 10FP4/R6025

... the NEW Picture Tube with
Unprecedented Brilliance

No Ion Trap
Required

Virtually
Flat Face

Direct
Viewing

NEW!
**ALUMINIZED
REFLECTOR-SCREEN**

Doubles the Brilliance
Highlight: 75 Foot Lamberts (avge.)
Contrast Range: Over 100 to 1
No Ion Spot—No Cathode Glow

Specifications of the Rauland Visitron 10FP4/R6025

Heater Voltage	6.3 A.C. or D.C.
Focusing Method	Electromagnetic
Deflection	Electromagnetic
Deflection Angle	50 Degrees
Screen	Phosphor P4 Aluminized Reflector
Bulb Diameter (Max.)	10 ⁵ / ₈ " at screen end
Length	17 ⁵ / ₈ " ± 3/ ₈ "
Base	Small Shell Duodecal 7 Pin
Anode Terminal	Cavity
Anode Volts (Max.)	13,000
Anode Volts (Operating)	9,000
External Coating (Optional): 500 mmf.	

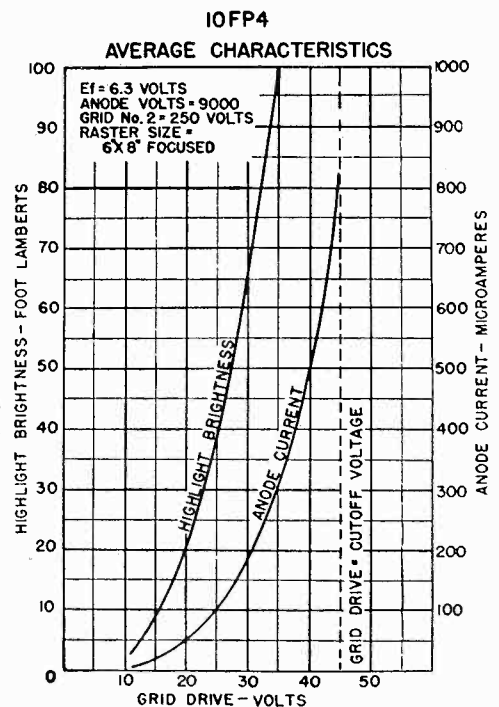

• WRITE FOR INTERESTING BULLETIN •

RADIO • RADAR • SOUND •

Rauland

COMMUNICATIONS • TELEVISION

Electroneering is our business

THE RAULAND CORPORATION • CHICAGO 41, ILLINOIS



HAYDON Automatic Reset

For applications such as time delay relays, where automatic re-setting is required, HAYDON engineers have built into the #1600 series gear unit a magnetically operated counterbalanced gear shift. This automatically engages and disengages the gear train when the motor field is energized and de-energized. The drive shaft is then reset back to starting position by an external spring. It gives uniform engaging and disengaging action, irrespective of the mounting position of the motor.

- This construction is available in speeds from 15 RPM down to one revolution in 10 minutes.

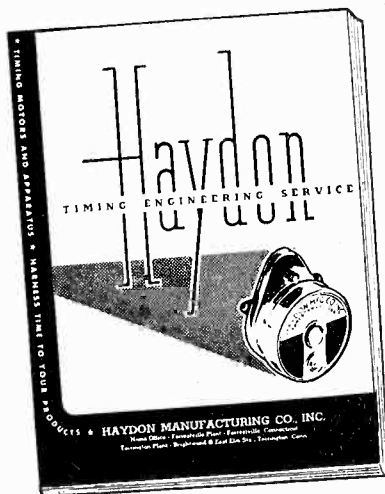

Write for the new HAYDON catalog for detailed description of this and other HAYDON timers.

TIMING ENGINEERING SERVICE
Haydon

MANUFACTURING COMPANY
INCORPORATED

Forestville, Connecticut

SUBSIDIARY OF GENERAL TIME INSTRUMENTS CORPORATION

appeared to offer advantages in solving this problem and the British Thomson-Houston Company has developed carrier-frequency equipment to relay six programs. This triples the selection now open to subscribers and reduces from four to two the number of wires needed to link them to the broadcast relay center. Provision of six channels accommodates three BBC programs and the sound accompaniment to BBC television, with two spare channels for foreign

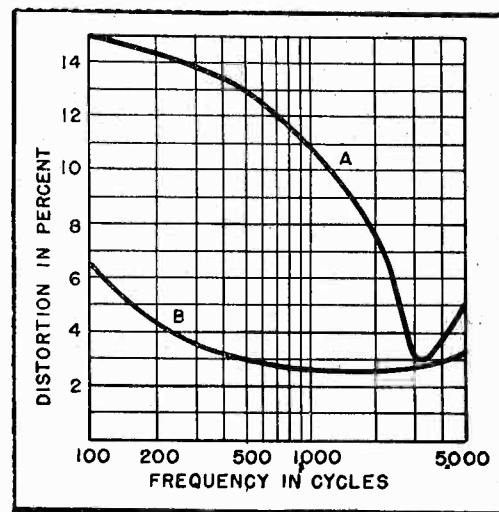

Curve A is an α -f distortion curve for a typical British broadcast receiver. Curve B shows the response of the carrier-frequency system

broadcasts and future developments in the home entertainment field.

Technical Details

The most efficient transmission line has been found to be two insulated copper conductors of 0.048-inch diameter, spaced two inches apart. Radiation from the line is negligible and allows selection of the carrier frequencies and frequency-spacings to give high fidelity reproduction without reference to any international conference.

Broadcast programs, whether received by landline from the BBC or through the ether, are fed into frequency-modulation equipment where the signal modulates the carrier frequency of the channel designated for transmission of the program. The resultant is amplified and piped into the distributing network. The carrier frequencies are generated by a crystal-controlled oscillator.

Comparative performance of the average broadcast receiver with the multi-broadcast reproducer is shown by the accompanying graphs.

Ever see a Picture of a Short Circuit?

Oscillogram taken on a 50 ampere breaker showing short circuit with 6450 amperes rms flowing through the breaker which interrupted within $\frac{1}{2}$ cycle on 120V AC with a power factor of approximately 60%.

This was the third operation on a circuit having a capacity of approximately 8000 amperes rms.

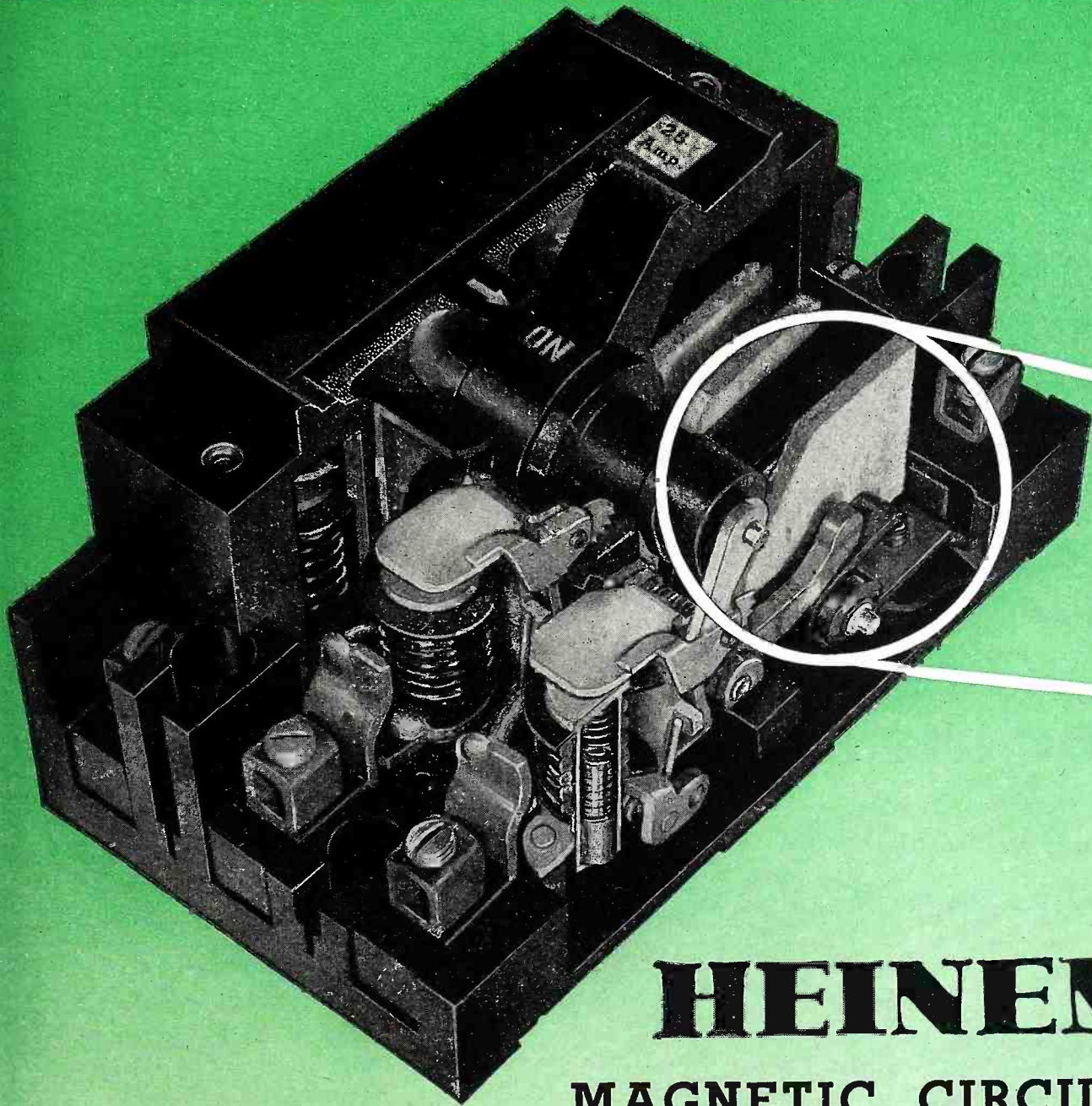
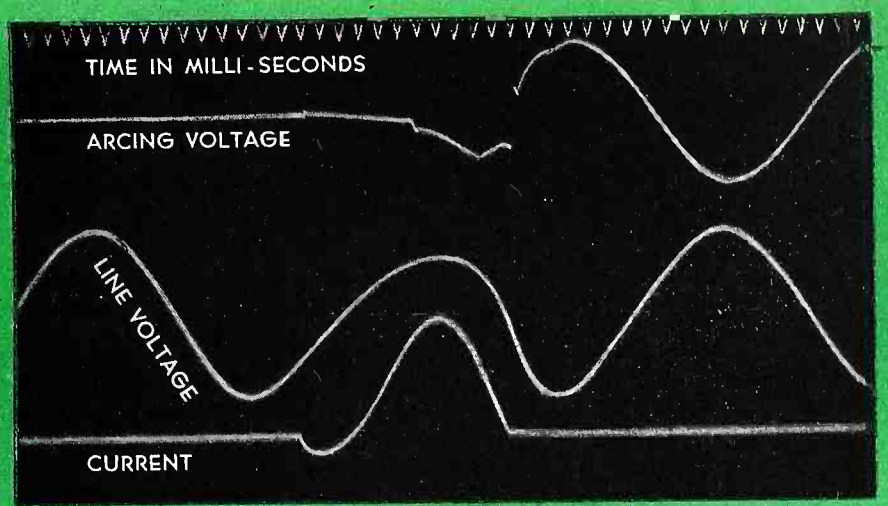

HEINEMANN

MAGNETIC CIRCUIT BREAKERS Employ High Speed Blowout

The stationary contact is coiled around an insulated iron core which connects the steel plates forming a U-shaped magnet. On overloads and short circuits the current flowing through the contact creates magnetic lines which force the arc into the arcing chamber and blow it out. As the value of the current to be interrupted increases, the quenching effect becomes greater due to the intensified magnetic blowout field.



HEINEMANN ELECTRIC COMPANY

Established 1888

97 PLUM STREET

TRENTON, N. J.

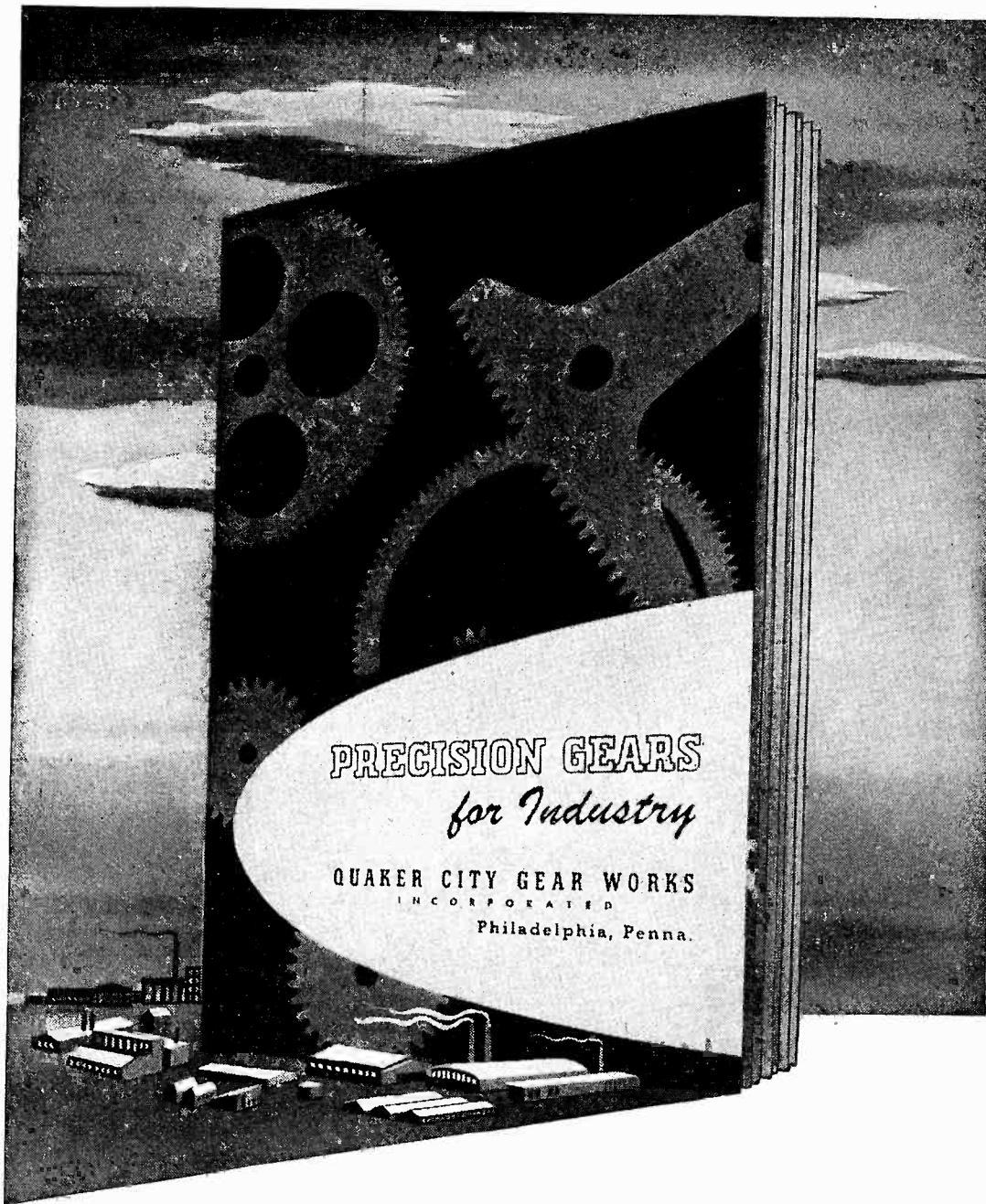

Yours for the asking

A new informative booklet on gears.

It has illustrated sections  on

practically every known form of gearing,

together with  many reference

tables and formulas. Write for your copy

today on your company stationery. 

 **Quaker City Gear Works**
INCORPORATED

1910 N. Front Street, Philadelphia 22, Pa.

INDUSTRIAL CONTROL

(continued from p 150)

oil companies to locate new oil deposits, and that branch concerned with the analysis and study of earthquakes and related phenomena.

The prospecting type of seismographs have long used electronics but it is only within the last year or so that electronic seismographs have been made available to colleges and other institutions interested in seismic research.

The ancient Chinese devised a

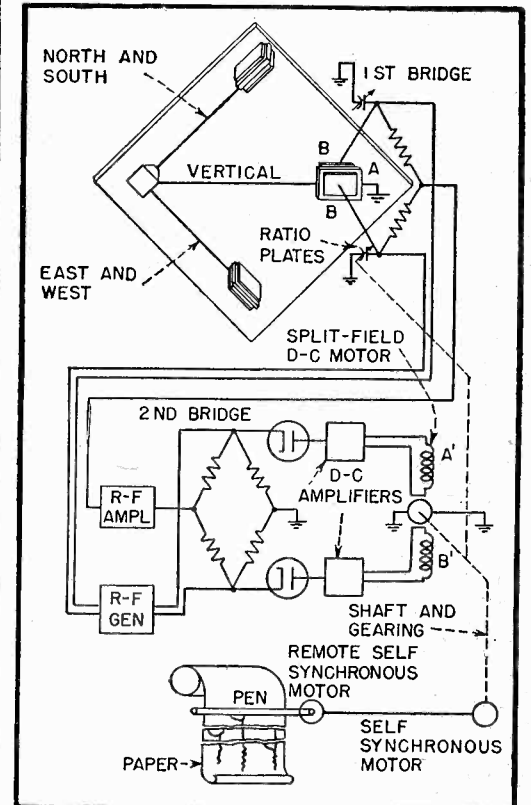

Arrangement of r-f bridges and d-c amplifiers used in the seismograph

dish with a cone imposed in the center. The apex of the cone contained a slight hollow upon which a comparatively large ball rested. When an earthquake occurred, the ball was shaken from the cone into the dish and the gyrations therein were observed.

Many years later, the swinging of a chandelier in an Italian church enabled Galileo to give us the pendulum. The pendulum as used in seismology acts simply as an inertia mass when earth motion causes its support to move. To capture the difference in motion between the inertia mass and components of the support and then record it is the object of all seismographs. The motion to be recorded from a distant earthquake is frequently on the order of three and four places to the right of the decimal point in fractions of an inch. Moreover, the least friction between the pendulum and its related components will have

ECONOMICAL SWITCHES

~~LINE~~

~~SLIDE~~

ROTARY ACTION

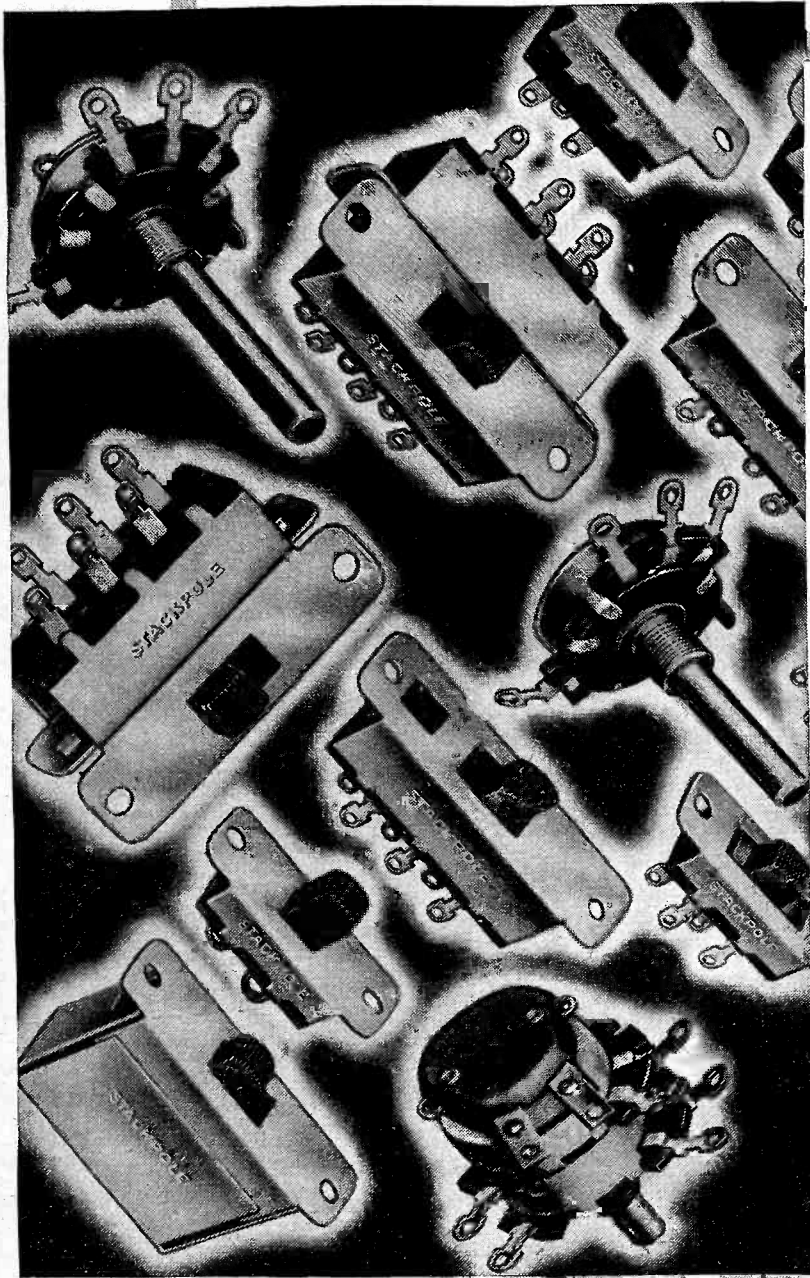

... for almost any appliance or instrument

Chances are Stackpole has the switch you need—at a price in keeping with your production budget. Eighteen standard types include 1-, 2-, 3- and 4-pole and 3-position switches, with or without detent, spring return, covers and other optional features. Special types and adaptations can be produced economically for large quantity users. They're fully dependable. They add greatly to the sales appeal and efficiency of any electrical product.

STACKPOLE CARBON CO. • St. Marys, Pa.



Write for Catalog RC-6 including Stackpole Switches, Fixed and Variable Resistors and Iron Cores.

STACKPOLE

FIRST QUALITY ELECTRONIC COMPONENTS

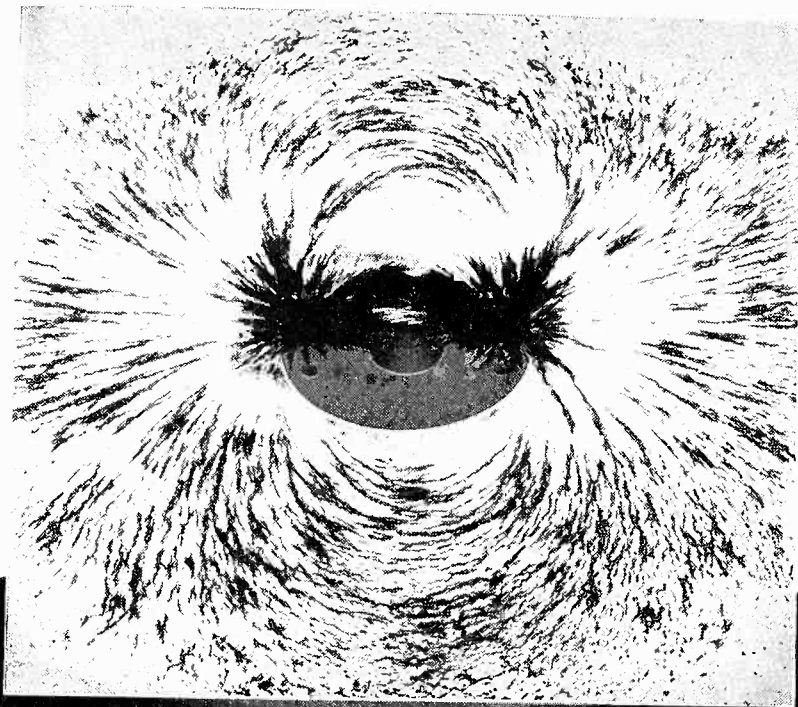

GREAT IMPROVEMENTS
 have been made in **PERMANENT**
MAGNET MATERIALS and
DESIGN during the last few years

● Now—**TODAY**—is the time to check your permanent magnet design to be sure you are getting maximum efficiency and performance at lowest possible cost.

Take advantage of Thomas & Skinner Steel Products Company's 46 years of experience in designing and fabricating permanent magnets—cast or formed. Write to us, outlining your problem. We will give you an answer based on the many advantages offered by today's materials and design.

NEW THOMAS & SKINNER CATALOG

Just off the press—a new Permanent Magnet Catalog—containing latest information on the use, design and fabrication of permanent magnets.

Fill in, cut out, mail coupon below.

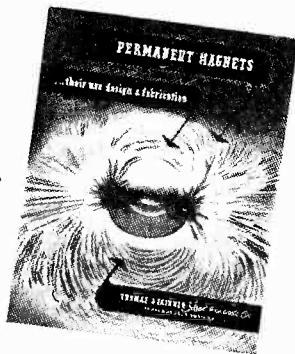

- Please send new Permanent Magnet Catalog
- Please have sales engineer call

NAME _____

COMPANY _____

CITY _____ STATE _____

THOMAS & SKINNER
STEEL PRODUCTS COMPANY

1122 EAST 23RD STREET • INDIANAPOLIS, INDIANA

the same effect as a rat's nest in a grandfather's clock.

For several years, satisfactory seismographs have been in operation which use a photographic method of amplification and recording. In such equipment, a mirror is attached to the pendulum and a light beam strikes the mirror, and in turn is reflected a given distance to photographic paper on a revolving drum. The distance between the mirror and photographic paper determines the amplification. Some types use a transducer at the pendulum and the current generated is passed through a galvanometer which contains the mirror. The principle is the same.

The photographic method, however, has certain features which involve considerable labor and expense, such as the daily changing and developing of records, all of which is done in a dark room. A seismologist never knows the characteristics of a 'quake until it is over and the record developed. Photographic paper and chemicals are expensive when used on a scale necessary to a well conducted station. Moreover, a separate instrument is required for each dimension of motion (North-South, East-West, and vertical).

Circuit

About a year ago, the writer, and Father Daniel Linehan, seismologist at the Jesuit College at Weston, Mass., with Dr. L. Don Leet of Harvard, acting as coach, decided to design an instrument which would take the drudgery out of operating a seismograph station.

The diagram shows a closed cycle servomechanism. At A is one of the pendula suspended between two fixed plates B that are two legs of a balanced r-f bridge circuit. When earth motion swings the pendulum, it causes an unbalance of this bridge. The unbalanced voltages are amplified and fed into a split-field motor. A variable capacitor which turns with the motor shaft rebalances the bridge.

The split-field motor is directly connected to a self-synchronous motor. Leads from this motor connect with a second self-synchronous motor in the recorder which activates the pen. Thus, the recorder can be placed any distance from the pendula. The three pendula (N-S,

CONFUSING?

OR

AMUSING?



Lead-In Lines Play an Important Part in Television Reception

The effects of attenuation and impedance mismatch on FM and Television reception are minimized by Anaconda Type ATV* lead-in lines.

The satin-smooth polyethylene insulation of Type ATV line sheds water readily, thus avoiding subsequent impedance discontinuities. This material also has exceptionally high resistance to corrosion. Count on Anaconda to solve your high-frequency transmission problems—with anything from a new-type lead-in line to the latest development in coaxial cables. 47-130

*An Anaconda Trade-Mark



A Type ATV Lead-In for Every Need

Anaconda offers a complete selection of Type ATV lead-in lines for 75, 125, 150 and 300 ohms impedance unshielded and 150 ohms shielded. For an electrical and physical characteristics bulletin, write to Anaconda Wire and Cable Company, 25 Broadway, New York 4, N. Y.



ANACONDA WIRE AND CABLE COMPANY



They used to call me
'THE CREEP'..'

... but that was before the boss discovered there was a *difference* in tracing cloths. Ink just can't help creeping and feathering when you use a French curve, if the tracing cloth has a poor surface."

Arkwright gives you the kind of surface that practically assures razor-sharp lines. Oil, wax and soap-free mechanical processing assures uniform capillarity. Even the weaving

and bleaching of special cloth is part of Arkwright's exhaustive system of standards, tests and inspections—to *prevent* pinholes, thick threads and the many other things that cause spoiled tracings, lost time.

Why not try Arkwright and see for yourself what a difference there is? Send for free working samples. Arkwright Finishing Company, Providence, R. I.

All Arkwright Tracing Cloths have these 6 important advantages

- 1 Erasures re-ink without "feathering" or "creeping".
- 2 Prints are always sharp and clean.
- 3 Tracings never discolor or become brittle
- 4 No surface oils, soaps or waxes to dry out
- 5 No pinholes or thick threads
- 6 Mechanical processing creates permanent transparency



Arkwright
TRACING CLOTHS

AMERICA'S STANDARD FOR OVER 25 YEARS

E-W, and vertical) are on a single base but each pendulum has a separate servomechanism, all of which feed into a single recorder.

All three pens record on a single paper tape and thus three dimensional motion is recorded simultaneously. Earthquakes can thus be observed in action.

No dark room is required and the recorder carries sufficient paper of the inexpensive adding machine quality and ink to operate nearly a week without attention. The recorder carries an alarm which gives warning with bell or buzzer when a major quake is being recorded. Time is indicated on the record every minute and hour by a built-in spring-wound precision clock, which has an error of approximately six seconds per week. This is important because time is the fourth dimension of seismology.

Improved GCA for Navy

TWO NEW devices have been added to the Navy's Ground Control Approach system to give the radar controller an accuracy never before achieved in directing plane movements. The first of these devices is a separate identification indicator which flashes on a compass rose above the search scope the bearing of any plane communicating with the tower on voice radio. This beam identifies each plane in its exact position with relation to the airport, eliminating confusion between indications of planes in the vicinity as they appear on the radar scope.

The second device is a radar height-finding antenna, indications

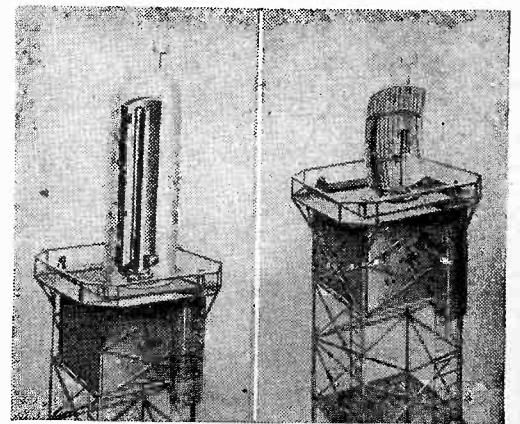

Height-finder antenna (left) and search antenna used in new GCA for covering distances up to 30 miles at altitudes up to 12,000 feet

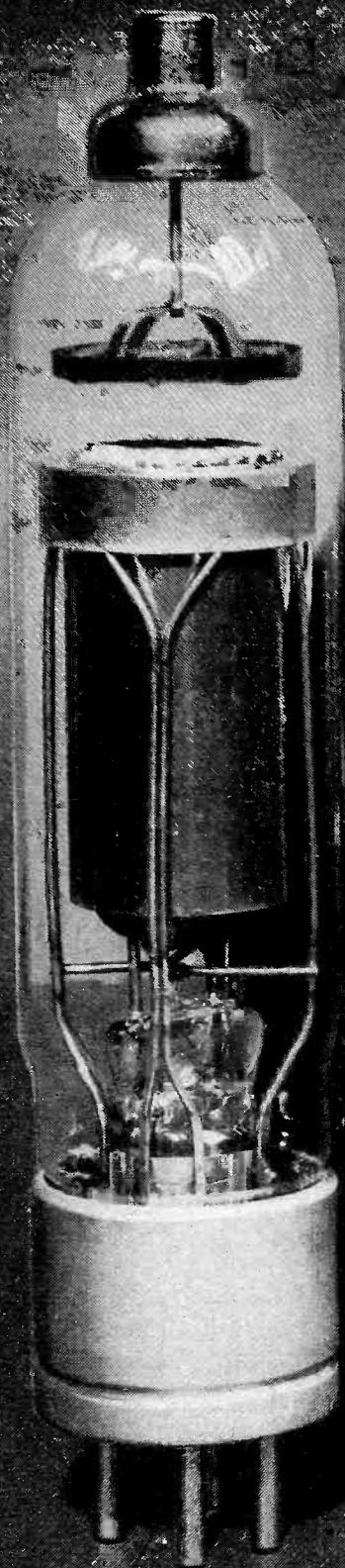

ELECTRONS INCORPORATED
127 SUSSEX AVENUE
NEWARK, N. J.

*For the precise control of
motor speeds...*

GRID CONTROL RECTIFIERS

"How about some **Control** around here,

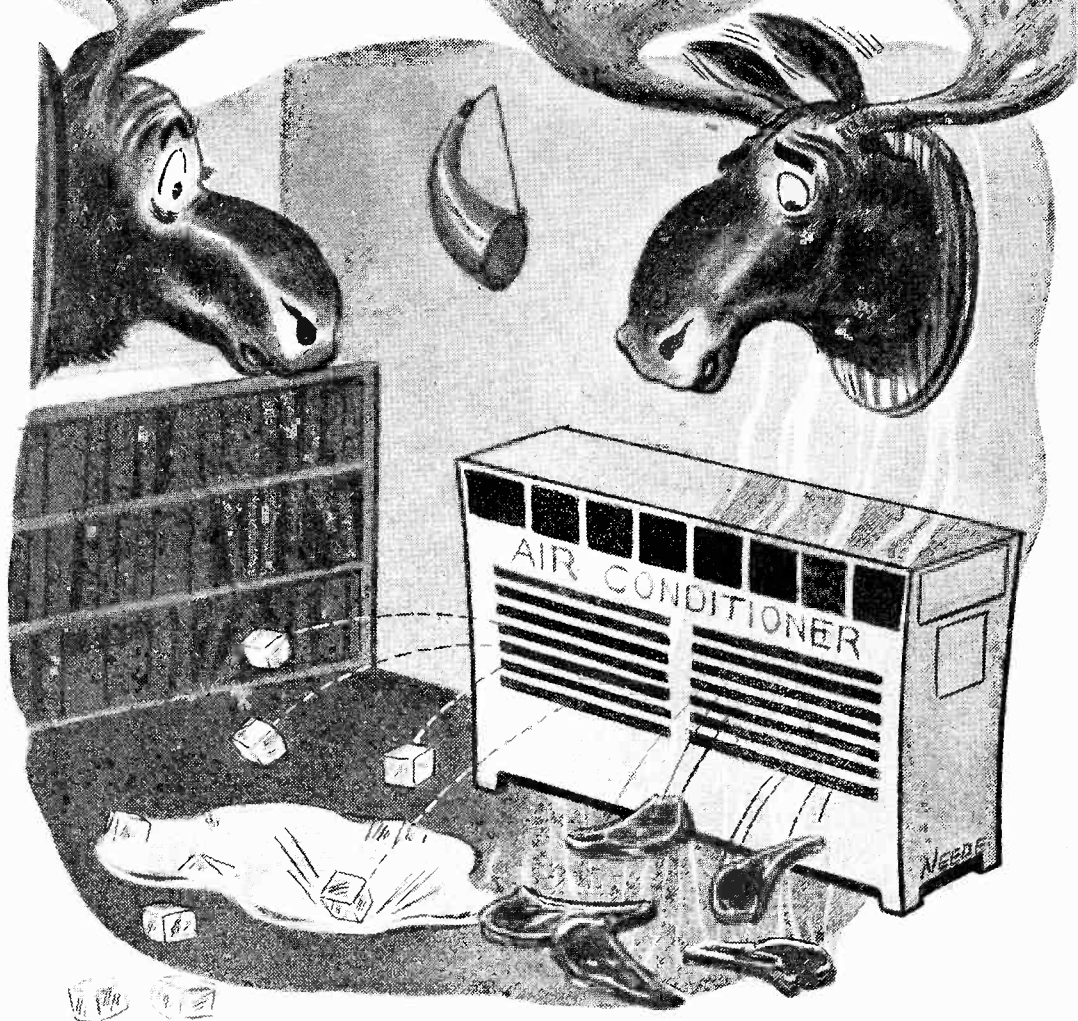

... with an **Adlake Relay!**"

Things don't go wrong when an Adlake Plunger-type Mercury Relay is on the job. And Adlake Relays can be used as controls in so many jobs, from air conditioning to burglar alarms! They're always dependable and tamper-proof. Here's why:

- Hermetically sealed contact mechanism—impervious to dust, dirt and moisture.
- Liquid mercury-to-mercury contact—no burning, pitting or sticking.
- Armored against outside vibration or impact—designed for either stationary or moving equipment.

Write today for free, illustrated folder. Address: The Adams & Westlake Company, 1106 N. Michigan, Elkhart, Ind.

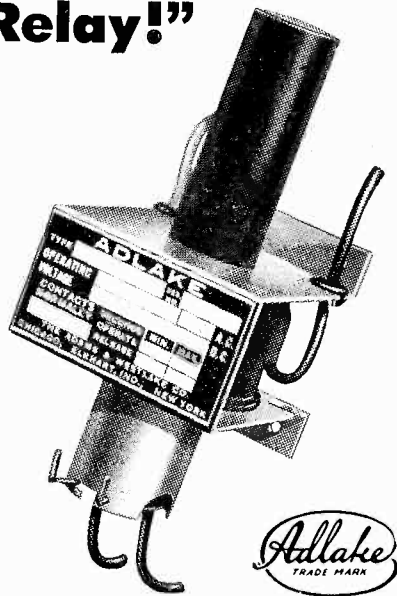

ADLAKE RELAY MODEL NO. 1040

THE Adams & Westlake COMPANY

Established 1857 • ELKHART, INDIANA • New York • Chicago

Manufacturers of Adlake Hermetically Sealed Mercury Relays for Timing, Load and Control Circuits

of which appear on an adjacent scope similar to the control scope. The zone air controller can point the antenna in any direction and read off the exact altitude of the plane on the height-measuring scope.

Navy experiments indicate that planes can be orbited about the field and fed into the landing path at a rapid rate so that the transition from the airways to the ground will be accomplished smoothly and without stacking of aircraft waiting to land. The first set will be installed at the Naval Air Station, Quonset Point, R. I., where special techniques will be evolved for a high rate of instrument landings. This will be the first permanent fixed operational installation of GCA.

This newest Navy set, designated AN/FPN-1 (XN-2) and built by Bendix Radio Division, will give the tower controller a radar picture of all planes within a radius of 30 miles and at all altitudes up to 12,000 ft. The installation will eliminate the necessity for a visual tower controller except for controlling the movements of taxiing planes.

Operation

The zone controller, who has before him the all-around search scope, the altitude finder, and identification beam will find the position and altitude of each individual plane. By means of voice radio, he will direct the planes into the landing path, while at the same time keeping an accurate check on their position and altitude. If the pilot does not follow the orders of the controller either in his flight pattern or altitude level, the controller will be able to correct his errors immediately, thus preventing collisions with buildings, radio

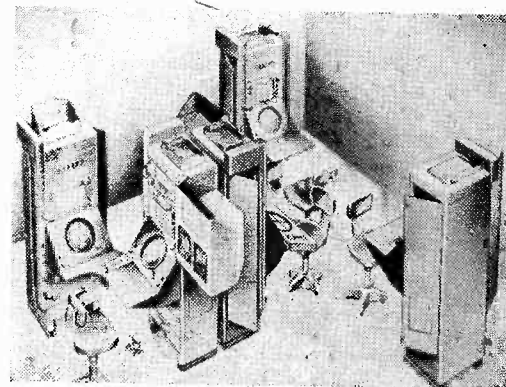

Control tower subdeck of new Navy GCA installation requiring only four operators, one for each chair

For economical large-quantity sheet metal stamping or forming

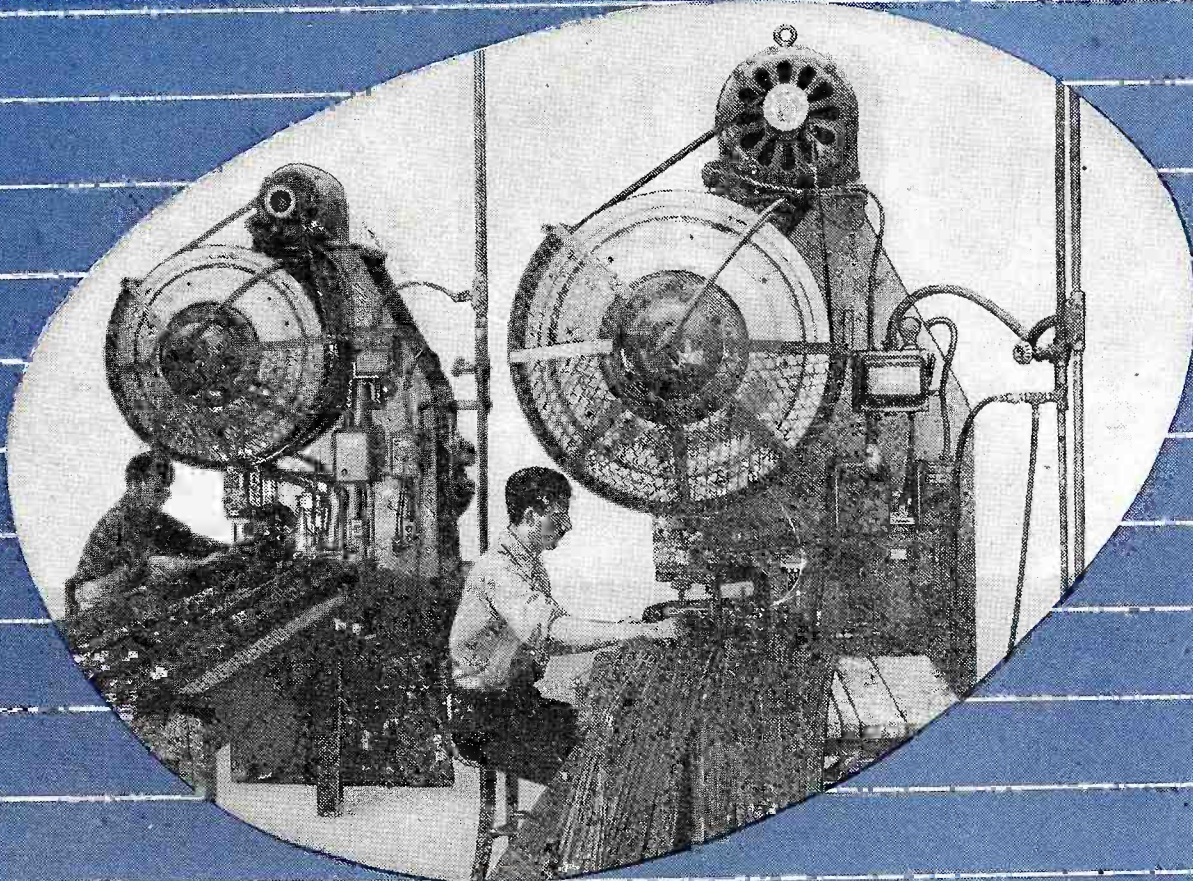

Call

COLGATE

To save production time and trouble on large-quantity runs, depend on Colgate for your sheet metal forming, stamping or fabricating.

Many manufacturers have found that there is no substitute for Colgate's long experience in manufacturing parts, sub-assemblies and finished products of aluminum, magnesium and stainless steel. Time and again, this experience, coupled

with Colgate's unusually complete modern facilities for mass production, has effected substantial savings in time and fabricating costs.

From the blueprint stage to finished assemblies, you can profit from the skills and applied experience of specialists in sheet metal forming, stamping and fabricating. Why not make Colgate your light metal department—for more efficient large volume production.

Specialists in Stamping and Fabricating Aluminum, Magnesium, Stainless Steel and Other Light Metals.

COLGATE *Manufacturing Corporation*

AMITYVILLE, LONG ISLAND, NEW YORK

OHIO MOTORS...

Application Proved For

TOP PERFORMANCE

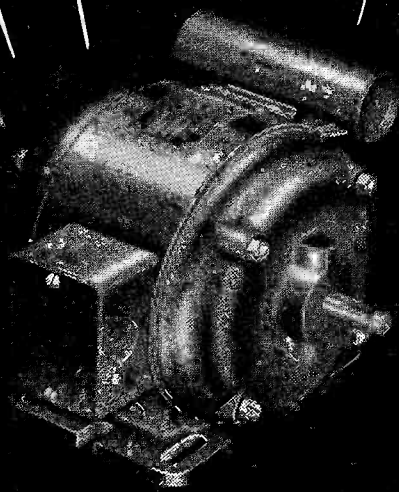

The extra depend- ability and
efficiency of Ohio  "Application
Proved" Motors is the result of meticulous
attention  to detail... from
the design  room through final
inspection. More than 100 tests are ap-
plied to every Ohio Motor.  To be
sure that your product will deliver
top performance, specify Ohio "Application
Proved" Motors.  Write today
for a copy of our catalog.

THE **OHIO ELECTRIC MFG. CO.**

CHESTER BLAND, PRESIDENT

5908 Maurice Ave.

Cleveland 4, Ohio

INDUSTRIAL CONTROL

(continued)

towers or other aircraft. Once the controller has the plane heading toward the runway, he turns over the control of the aircraft to the landing path controller, who, by means of his precision radar scope, is able to direct the plane in its final approach to a safe landing on the runway.

The approach system is a precise radar system covering a 20-degree azimuth sector and a 7-degree sector in elevation. These sectors are displayed as expanded views each on 12-inch cathode-ray tubes. When an approaching aircraft has been directed to a distance of six nautical miles from the airfield and into this sector, control of its altitude and azimuth is taken over by the two precision operators. By very accurate means each operator continuously bisects with a cross-hair device the radar indication of the aircraft. This tracking operation is translated into direct indication in feet relative to the correct glide path by an electromechanical device and appears upon a third cathode-ray display. Final direction of the aircraft is accomplished from this accurate data rather than from the original azimuth and elevation cathode-ray display tubes, because information accurate to a matter of a few feet is essential.

Thirteen Navy mobile GCA stations using wartime equipment are now in operation, at the Marine Corps Air Station in El Toro, Calif. and at the following Naval Air Stations: Charlestown, R. I., Corpus Christi, Texas; Jacksonville, Florida; Miramar, Calif.; New York, N. Y.; Oakland, Calif.; Oceana, Virginia Beach, Va.; Olathe, Kansas; Patuxent River, Md.; Saufley Field, Florida; Seattle, Wash.; Whidbey Island, Wash.

16,000 Tubes Work for One Railroad

THE PENNSYLVANIA Railroad used 15,994 electronic tubes last year, more than 100 different kinds. The earliest use, prior to 1920, was a rectifier to convert a-c to d-c for charging storage batteries. Since that time, their use has expanded, and today they are used in such service as telephone repeaters—for long distance phone service, loud-

FOR LONG, EFFICIENT LIFE...

... A STURDY

heart



Rectifiers are the heart of the power circuits: ENGINEERED FOR ENGINEERS, Selenium Rectifiers are rapidly becoming standard for all industry.

Selenium Corporation of America meets exacting specifications of modern electronic developments in manufacturing a broad line of Selenium Power and Instrument Rectifiers, Self generating Photo-Electric Cells and allied scientific products.

Selenium Corporation of America's engineering and manufacturing experience can be called upon for the development and production of special rectifiers for any applications.

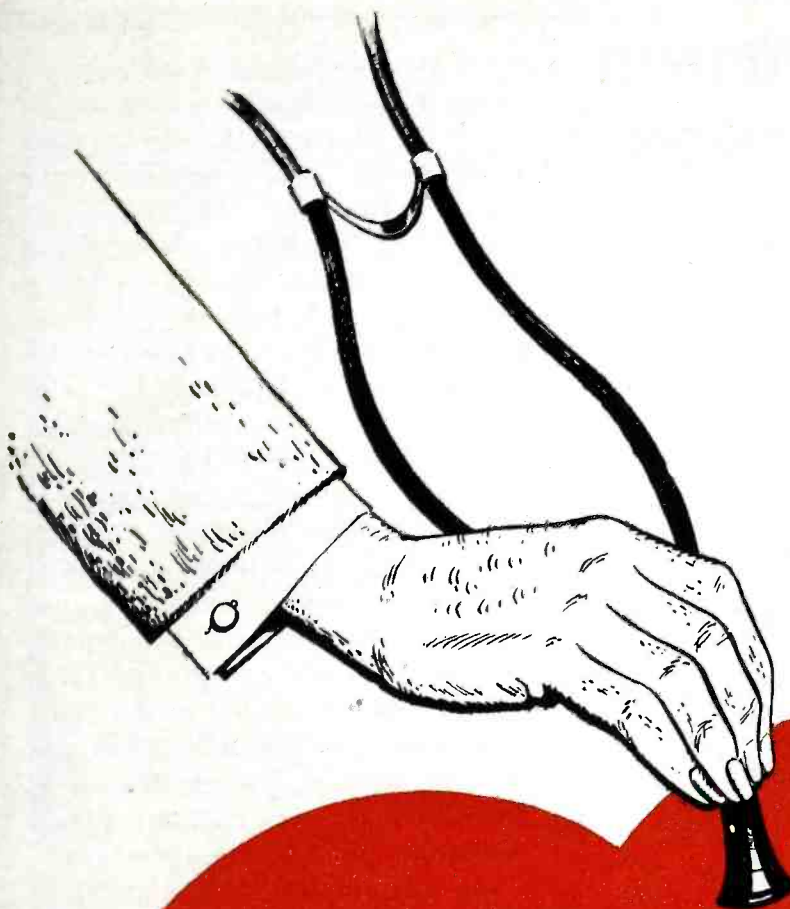

INSTRUMENT RECTIFIERS

POWER RECTIFIERS

PHOTO-ELECTRIC CELLS

SELENIUM CORPORATION OF AMERICA

Affiliate of VICKERS Incorporated

2160 EAST IMPERIAL HIGHWAY, EL SEGUNDO, CALIF.



CHECK THESE OUTSTANDING FEATURES:

- ✓ Unlimited life—no moving parts.
- ✓ Permanent characteristics.
- ✓ Adaptability to all types of circuits and loads.
- ✓ Immunity to atmospheric changes.
- ✓ High efficiency per unit weight.
- ✓ From 1 volt to 50,000 volts rms.
- ✓ From 10 micro-amperes to 10,000 amperes.
- ✓ Economical—simple to install—no maintenance cost.
- ✓ Hermetically sealed units available.

Announcing...THE NEW TURNER MODEL 20X HAND MICROPHONE

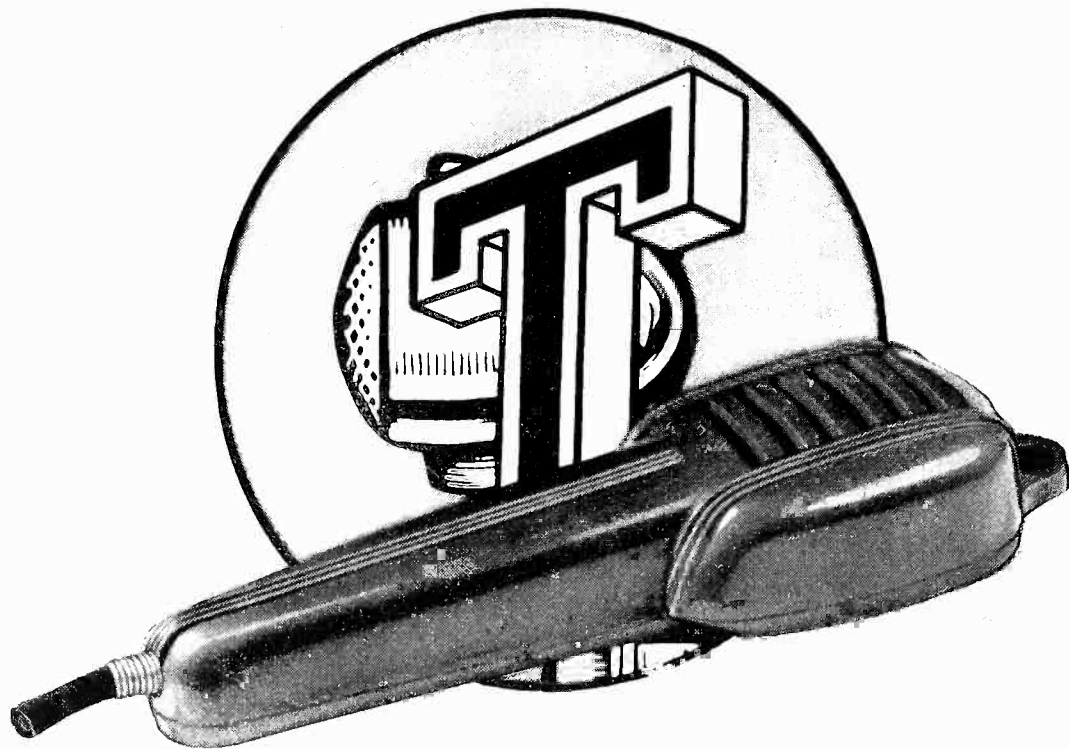

**a little mike
with a BIG future**

We're mighty proud of this new addition to the line of Microphones by Turner. Small in size yet *big in performance* it inherits those qualities of sound engineering and careful workmanship that have made the name Turner a symbol for precision and dependability.

The New *Model 20X* is designed to appeal to owners of home recorders and amateur communications equipment. It has innumerable applications in offices and factories and for paging and call system work. Sound pressure tests reveal remarkable performance characteristics for a low priced unit. Its circuit features a Metalseal crystal which withstands humidity conditions not tolerated by the ordinary crystal. Response to voice and music is smooth and flat within ± 5 db from 40-7000 c. p. s. Level is 54db below 1 volt/dyne/sq. cm. Finished in lustrous brown baked enamel, the *Model 20X* is light in weight and natural to hold. It may be hung on a hook. Furnished complete with 7 ft. attached shielded cable.

WRITE FOR BULLETIN

THE TURNER COMPANY

905 17th Street N. E. • Cedar Rapids, Iowa

Microphones **BY TURNER**

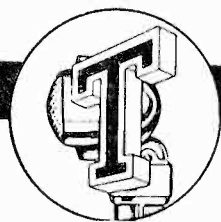

"THE PASSWORD TO SOUND PERFORMANCE"

LICENSED UNDER U. S. PATENTS OF THE AMERICAN TELEPHONE AND TELEGRAPH COMPANY, AND WESTERN ELECTRIC COMPANY, INCORPORATED. CRYSTALS LICENSED UNDER PATENTS OF THE BRUSH DEVELOPMENT COMPANY.

INDUSTRIAL CONTROL

(continued)

speaker systems for yard service, train announcing and paging in stations, wreck train service, carrier telephone and teletypewriter service, charging equipment for communication power plants, train telephone service, recording devices for recording telephone conversations and conferences, test equipment for testing telephone and teletypewriter circuits, and inter-office communication systems.

The first important application of electronic tubes on P.R.R. locomotives and cars was in the amplifiers of the train control and cab-signal system with the original and experimental installation made in 1923. This use has expanded to the point where several thousand tubes are now in service. During the early and middle thirties, radio broadcast reception for entertainment purposes was provided on a number of trains, followed sometime later with public address systems on a few trains for announcements.

Recent use of electronic tubes and devices on railway vehicles is in the trainphone system for telephone communication between locomotives, cabin cars and wayside offices. In this system, over twelve thousand tubes are now in daily use.

In the signal department, phototubes are employed for supplementary protection at remote interlocked switch to detect presence of train on track circuit, and as drawbridge aligners. There is a proposed use of detecting presence of a train on hand-operated crossover in automatic territory.

Rectifier tubes are found charging storage batteries and on pulsating or half-wave d-c track circuits.

Other tube types are used on high-frequency circuits superimposed on existing line wires for control of check locking between adjacent block stations and on existing line wires for C.T.C. control. At locations where 100-cycle a-c power is not available they convert 60-cycle power to 100-cycle power.

Motor Control for Polio Patients

To COMBAT polio after effects, Respir-Aid, Inc. of Toledo makes a bed mounted on a motor-driven frame which is driven by G-E Thy-

VARFLEX CORPORATION, manufacturer of electrical insulation,

invites you to—

Test these Free Samples

HERE IS A BRIEF DESCRIPTION OF VARFLEX PRODUCTS

VARGLAS SILICONE PRODUCTS are fabricated from continuous filament Fibreglas yarns combined with Silica resin in various degrees of coating. Retain flexibility, electrical properties and mechanical strength within a temperature range of -85° F. to 500° F.

1. VARGLAS SILICONE TUBING GRADE A. Recommended for applications requiring extremes of heat endurance and very high dielectric strength (average 1900 volts). GRADE B is identical except for dielectric strength (average 4000 volts).

2. VARGLAS SILICONE SATURATED SLEEVING. Available in Grades C-1 (average 2500 volts) and C-2 (average 1500 volts).

3. SILFLEX SLEEVING. A tight coating of Silicone resin on Fibreglas braid. Extremely flexible. No dielectric strength.

4. VARGLAS SILICONE LEAD WIRE and YARCHROME RESISTANCE WIRE are made from solid or stranded wire coated with one or more walls of Fibreglas braid and impregnated with Silicone resin.

5. VARGLAS SILICONE TYING CORD is made in sizes from 1/64" to 1/8" O.D. Silicone treatment on continuous filament Fibreglas Tying Cord.

6. VARGLAS TUBING — TYPE YS SYNTHETIC is made in both Grades A and B. Note the flexibility of this Grade A sample (17000 volts). It is ideal for applications requiring the heat endurance of asbestosous varnish. (400°-425°). Non-fraying, non-inflammable and will not crack or become brittle after aging. This is a superior product which is being used extensively where insulation requirements are unusually rigid.

7. VARGLAS SLEEVING — TYPE RW SYNTHETIC. Slightly less flexible than YS Synthetic Treated Tubing but has higher heat resistance — up to 500° F. Made in Grades C-1 and C-2. Also

8 & 9. VARGLAS YARNISHED AND LACQUERED TUBING have flexible continuous coatings of flame resistant varnish or lacquer built up over Fibreglas braid in 8 or more carefully controlled operations. Varnished Tubings have flatter walls and greater heat resistance than the lacquered tubing but are slightly less flexible.

10, 11 & 12. VARGLAS SLEEVING. These three grades of sleeving are similar except for dielectric strength. Normally, the impregnant is asbestosous varnish. However, lacquer may be used if it better suits your requirements.

13. VARGLAS NON-FRAY SLEEVING — TYPE H. The non-fraying treatment gives the Fibreglas braid the organic impurities and tends to hold the individual fibres together. The lack of any bonding agent means it may be subjected to temperatures as high as the glass itself — up to 1200° F. Recommended for applications where dielectric requirements are not of prime importance.

14. VARGLAS NON-FRAY SLEEVING — TYPE HP. Similar to Type H but dyed various colors for coding purposes.

15. VARGLAS NON-FRAY SLEEVING — TYPE HO. Comparable to regular Varflex Sleeving except for the normalizing treatment before saturation with varnish. Available in three grades. Superior non-fraying qualities.

16. VARGLAS SLEEVING — TYPE P. Fibreglas braid with vinyl type coating. Available in three grades. More flexible than the asbestosous varnish coatings. Heat endurance is intermediate between lacquer and varnish.

17. VARGLAS LITWALL TREATED SLEEVING. Available in three grades. Wall thicknesses .005" and .008". Various I.D. sizes.

18. VARGLAS LITWALL UNTREATED SLEEVING is the same as Item 15 except the braid is not treated in any way. Both treated and untreated sleeving are put up on fibre spools.

19. SYNTHOLYAR EXTRUDED TUBING. Electrical Grade to match from a standard formulation of vinyl polymers. It has high dielectric and tensile strength. Will not support combustion nor char in moisture. Its smooth surface, thin wall and unusual flexibility all make for ease in assembling operations.

20. SYNTHOLYAR EXTRUDED TUBING. Type H.H. is basic to the same as Type E.G. but better suited for use where higher operating temperatures are involved.

21 & 22. VARFLEX COTTON TUBING. These tubings are furnished in Grades A or B with lacquer or varnish as the impregnant. They are braided from long staple cotton yarns and are perfectly suited for any applications where the superior qualities of the Fibreglas products are not required.

23, 24 & 25. VARFLEX COTTON SLEEVING. These three grades of sleeving are similar except for dielectric strength. Normally, the impregnant is asbestosous varnish. However, lacquer may be used if it better suits your requirements.

MORE COMPLETE DATA AVAILABLE ON REQUEST

VARGLAS SILICONE PRODUCTS

1. VARGLAS SILICONE TUBING GRADE A
2. VARGLAS SILICONE TUBING GRADE B
3. VARGLAS SILICONE SATURATED SLEEVING GRADE C-1
4. VARGLAS SILICONE SATURATED SLEEVING GRADE C-2
5. SILFLEX SLEEVING
6. VARGLAS SILICONE LEAD WIRE
7. YARCHROME RESISTANCE WIRE
8. VARGLAS SILICONE TYING CORD
9. VARGLAS TUBING — TYPE YS SYNTHETIC
10. VARGLAS SLEEVING — TYPE RW SYNTHETIC
11. VARGLAS YARNISHED TUBING
12. VARGLAS LACQUERED TUBING
13. VARGLAS NON-FRAY SLEEVING — TYPE H
14. VARGLAS NON-FRAY SLEEVING — TYPE HP
15. VARGLAS NON-FRAY SLEEVING — TYPE HO
16. VARGLAS SLEEVING — TYPE P
17. VARGLAS LITWALL TREATED SLEEVING
18. VARGLAS LITWALL UNTREATED SLEEVING
19. SYNTHOLYAR EXTRUDED TUBING — TYPE EG
20. SYNTHOLYAR EXTRUDED TUBING — TYPE H.H.
21. VARFLEX COTTON TUBING
22. VARFLEX COTTON TUBING — Yarnished
23. VARFLEX COTTON SLEEVING — Type A-1
24. VARFLEX COTTON SLEEVING — Type A-2 (Lacquered)
25. VARFLEX COTTON SLEEVING — Type A-3

See for yourself how new developments can give you better electrical insulation

● Varflex Corporation wants every manufacturer of electrical equipment to have one of these new folders. Each one contains actual working samples of 20 different types of sleeving and tubing, including *Varglas Silicone*, which was developed during the war to meet temperature variations from -85° F. to 500° F.

Write for this folder containing test samples today.



Varflex Corporation, 308 N. Jay St., Rome, N. Y.

Please send me your FREE folder containing 20 different types of electrical insulation. I am particularly interested in samples suitable for.....

Name.....

Company.....

Street.....

City..... State.....

NOW— A QUALITY 2-KW INDUCTION HEATING UNIT

for only
\$650

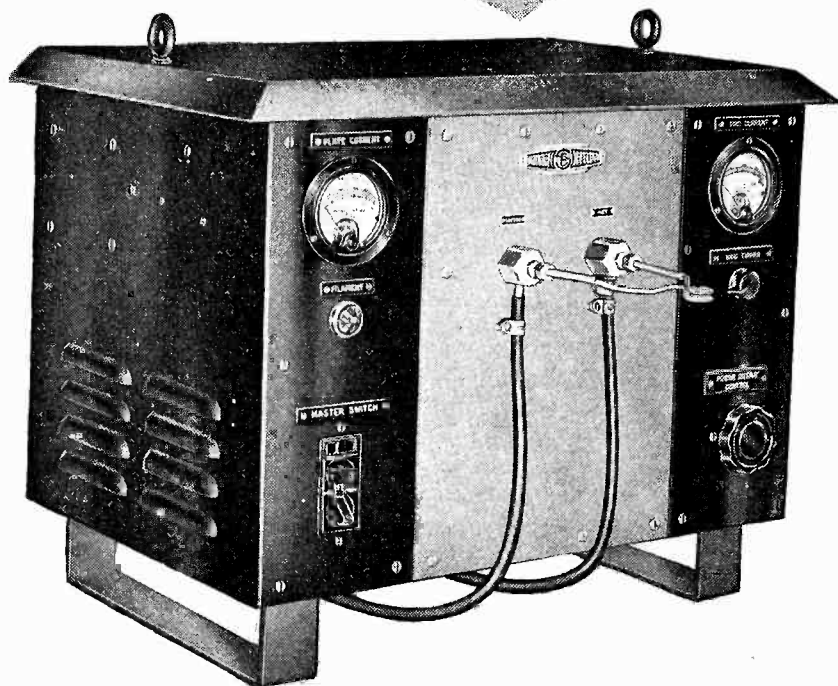

Never before a value like this new 2-KW bench model "Bombarder" or high frequency induction heater . . . for saving time and money in surface hardening, brazing, soldering, annealing and many other heat treating operations.

*Simple . . . Easy To Operate . . .
Economical Standardization of Unit
Makes This New Low Price Possible*

This compact induction heater saves space, yet performs with high efficiency. Operates from 110-volt line. Complete with foot switch and one heating coil made to customer's requirements. Work coil 1/2 to 2 1/2 in. diameter. Unit will work with coil of one turn to a maximum of 20 turns. Cost, complete, only \$650. Immediate delivery from stock.

Scientific Electric Electronic Heaters are made in the following range of power: 1-3-5-7 1/2-10-12 1/2-15-18-25-40-60-80-100-250KW. — and range of frequency up to 300 Megs. depending on power required.

Scientific Electric

DIVISION OF

"S" CORRUGATED QUENCHED GAP CO., 107 MONROE ST., GARFIELD, N. J.

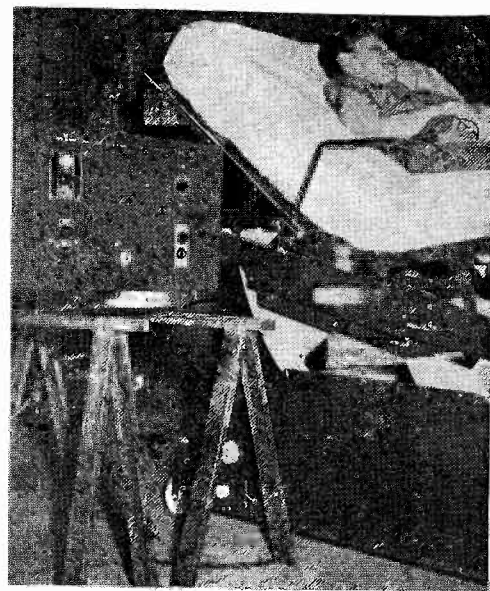

Breathing of polio victims is aided by this oscillating bed driven by a G-E Thy-mo-trol-controlled motor

mo-trol drive to see-saw in rhythm with the patient's normal breathing. By turning a small knob which controls the speed of the driving motor, an attendant can regulate the speed. A small a-c motor regulates the arc of travel of the bed's motion.

The bed aids the patient in breathing and need not be limited to polio victims, since it has many other uses in treating respiratory and circulatory diseases. The patient may sleep in any position without losing the effectiveness of the treatment. Neither the bed nor the motion restricts usual care or treatment of the patient in any way.

TUBE TESTER

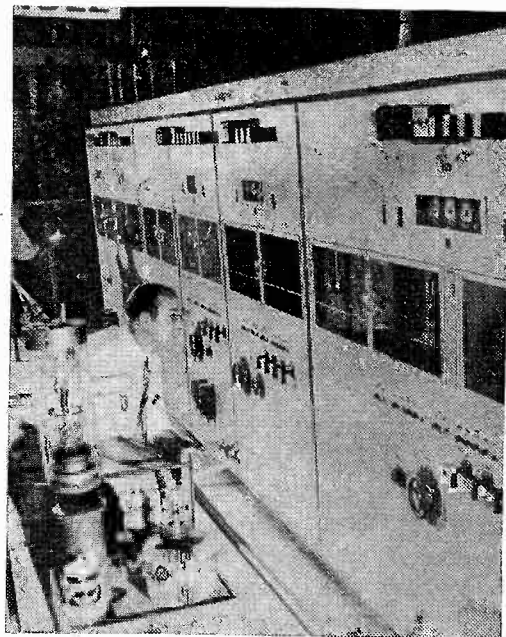

Water-cooled and force-air-cooled tubes up to 500-kw rating can be tested in this tube performance analyzing equipment built at General Electric tube engineering laboratory

NOW... A NEW GRAPHITE FOR ELECTRONIC TUBES

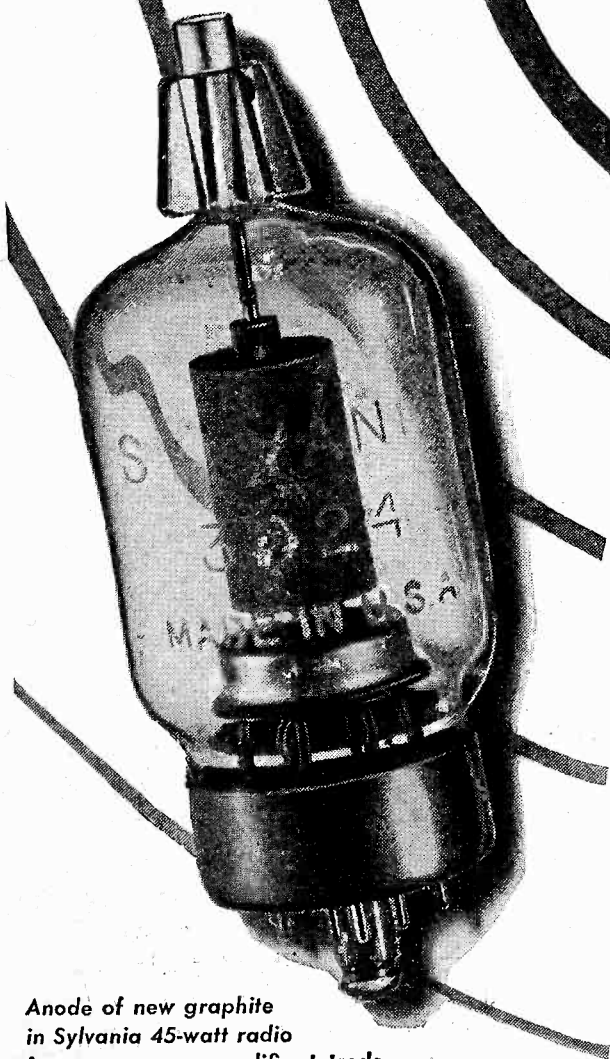

Anode of new graphite
in Sylvania 45-watt radio
frequency power amplifier tetrode.

HERE is a new grade of graphite that makes possible the design of greatly improved and more economical power tubes. This graphite, developed as a result of wartime needs, is *stronger than ever before*. It has *finer grain structure*. And it is the *purest graphite* ever produced for this purpose.

Sylvania Electric Products, Inc., is taking advantage of this "National" graphite in the first of a new line of transmitting tubes currently being announced.

This new "National" graphite offers you many advantages. It has no melting point and does not distort at highest temperatures. It has high *thermal emissivity*, thus permitting heavy overloads of the anode and providing a welcome reserve of plate dissipation. Also it has unmatched thermal conductivity.

Write for complete details. Address National Carbon Company, Inc., Department E.

The word "National" is a registered trade-mark of
NATIONAL CARBON COMPANY, INC.
30 East 42nd Street, New York 17, N. Y.
Unit of Union Carbide and Carbon Corporation



Division Sales Offices: Atlanta, Chicago, Dallas, Kansas City,
New York, Pittsburgh, San Francisco

• "There is a design trend toward the use of graphite for some tube applications where the greatest economy is desirable and at the same time allowing greater capability of tubes both mechanically and electrically." . . . H. W. Parker, of Sylvania Electric Products, Inc., in *Radio News*, October, 1946.

**MEASURES 0.0001 OHM
TO 11.11 MEGOHMS**

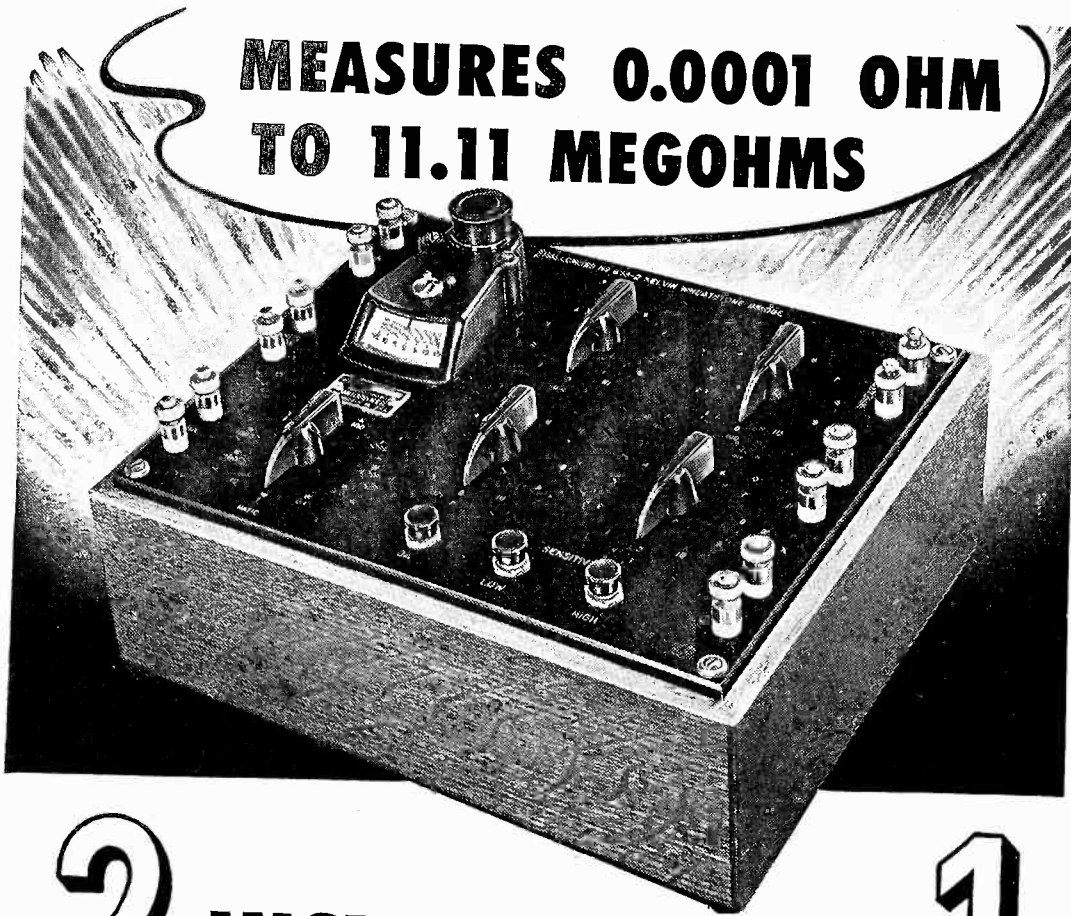

2 INSTRUMENTS IN 1
**Shallcross Combined Kelvin-
Wheatstone Bridge #638-2**

Save time and money by making both low and high resistance measurements with this single portable and highly durable instrument. Ideal for production, field or laboratory work that requires a dependable instrument of a type that doesn't have to be kept under lock and key because of extreme delicacy and high cost.

Used as a Wheatstone Bridge for measurements between 1 ohm and 1 megohm, normal accuracy is better than 0.3%. Low resistance measurements on the Kelvin range utilize current and potential terminals to eliminate lead and contact resistance. Kelvin measurement accuracy is 3% or better, which is satisfactory for most all low resistance measurements. Write for the Shallcross D-C Bridge Bulletin.

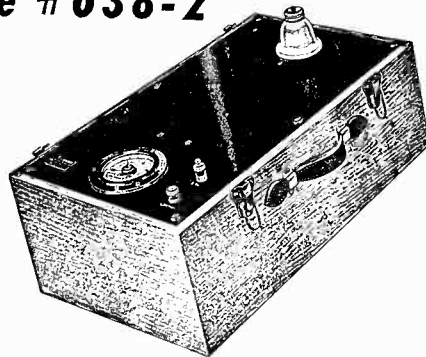

**HEADQUARTERS FOR
HIGH-VOLTAGE
TEST EQUIPMENT**

Shallcross Kilovoltmeters, Kilovoltmeter Multipliers and Corona Protected Resistors are available in types for practically all high-voltage test and measurement purposes. Special high-voltage instruments designed to match your needs. Write for Shallcross Bulletin F.

**SHALLCROSS MANUFACTURING
COMPANY**

ENGINEERING • MANUFACTURING • DESIGNING

DEPARTMENT E-47 COLLINGDALE, PA.

ELECTRON ART
(continued from p 154)

- tronics and High Speed Airborne Vehicles, paper presented at the American Association for the Advancement of Science convention in Boston, Dec. 1946. A survey of the terminology and problems of guided missiles.
- (2) Ackerman, Sam L., and George Rapaport, Radio Control Systems for Guided Missiles, *ELECTRONICS*, p 86 Dec 1946.
- (3) Selvidge, Harner, Guided Missiles in World War II, *Proc Radio Club of Am*, Oct 1946. Types of Allied and German guided missiles developed recently.
- (4) Fink, Donald G., Electronics at Bikini, *ELECTRONICS*, p 84 Nov 1946.
- (5) Huntoon, R. D., and B. J. Miller, Generator-Powered Proximity Fuze, *ELECTRONICS*, p 98 Dec 1945.
- (6) Selvidge, Harner, Proximity Fuzes for Artillery, *ELECTRONICS*, p 104 Feb 1946.
- (7) Mofenson, Jack, Radar Echoes from the Moon, *ELECTRONICS*, p 92 April 1946.
- (8) Sulzer, G. P., Ionosphere Measuring Equipment, *ELECTRONICS*, p 137 July 1946.

**AIEE Winter Meeting—
A Technical Summary**

EXPANSION OF INDUSTRIAL USES of the many forms of electrical power was reflected in the size and scope of the Winter Meeting of the American Institute of Electrical Engineers held in New York City from January 27 to 31. Technical program was the largest held by the Institute; over 160 formal papers were presented before a total registration of 3,629, some thousand over the previous record attendance. Subjects of papers ranged from a description of new New York City subway cars that have individual amplifiers and loudspeakers so that trainmen can announce the next station stop, to a statistical analysis of the chances that a radar echo will be recognized as an echo and not as noise.

Awards

Dr. Lee de Forest was awarded the 1946 Edison Medal for his pioneering achievements in radio and invention of the grid-controlled vacuum tube because of its profound technical and social consequences. Dr. de Forest holds over 300 patents in fields of radio telegraphy and telephony, sound for motion pictures, facsimile, television, and radio therapy.

The John Fritz Medal, awarded annually by the Am Inst of Elect Engrs, the Am Inst of Min and Met Engrs, the Am Soc of Civil Engrs, and the Am Soc of Mech Engrs, for scientific and industrial achievements in the production and utilization of electrical energy was presented to Dr. Lewis W. Cubb, Director of the Westinghouse Lab-

NOW you can get Sylvania quality in transmitting tubes too!

SYLVANIA INTRODUCES THE TYPE 3D24

BEAM POWER TETRODE WITH ELECTRONIC GRAPHITE ANODE

First of Sylvania's new line of transmitting tubes, the 3D24 is a four-electrode amplifier and oscillator with 45 watt anode dissipation. An outstanding development is the electronic graphite anode, which allows high plate dissipation for small area and maintains constant inter-element relationship and uniform anode characteristics.

The 3D24 may be used at full input up to 125 Mc — maximum permissible frequency will be announced later upon completion of tests.

OTHER FEATURES INCLUDE:

1. **Lock-In base.** Short leads, no soldered joints.
2. **Top cap** providing for short path, greater cooling by radiation and convection, resulting in a cooler seal.
3. **Thoriated tungsten filament**, giving high power output per watt of filament power.
4. **Vertical bar grids.** #1 grid supplied with two leads for better high frequency performance. #2 grid provided with heat-reflecting shield for greater dissipation, low grid-plate capacity.
5. **Low interelectrode capacity.** No neutralizing needed with proper circuit arrangement.
6. **Hard glass envelope.** Permits high power for small size.

The 3D24, a product of the Electronics Division of Sylvania, has interesting potentialities in amateur, police, mobile and marine radio.

MECHANICAL SPECIFICATIONS

Type of cooling Air—radiation and convection
 Mounting position Vertical, base down or up
 Length overall 4.3 inches max.
 Seated height 3.769 inches
 Diameter 1½ inches
 Net weight 1.3 ounces

ELECTRICAL CHARACTERISTICS

Filament Voltage 6.3 volts
 Filament Current 3.0 amperes
 Amplification Factor50
 Direct Interelectrode Capacitances
 Grid-Plate 0.2 $\mu\mu\text{f}$ max.
 Input 6.5 $\mu\mu\text{f}$
 Output 2.4 $\mu\mu\text{f}$



3D24		
TYPICAL OPERATING CONDITIONS		
R. F. Power Amplifier and Oscillator — Class C Telegraphy		
Characteristic	C. C. S.	C. C. S.
D. C. Plate Voltage	1500 volts	2000 volts
D. C. Control Grid Voltage	-300 volts	-300 volts
D. C. Screen Grid Voltage	375 volts	375 volts
D. C. Plate Current	90 ma	90 ma
D. C. Control Grid Current	10 ma	10 ma
D. C. Screen Grid Current	22 ma	20 ma
Peak R. F. Grid Input Voltage	400 volts approx.	400 volts approx.
Full Driving Power	4.0 watts approx.	4.0 watts approx.
Plate Power Output	105 watts	140 watts

Direct inquiries to Radio Tube Division, Emporium, Pa.

SYLVANIA ELECTRIC

MAKERS OF ELECTRONIC DEVICES; RADIO TUBES; CATHODE RAY TUBES; FLUORESCENT LAMPS, FIXTURES, WIRING DEVICES; ELECTRIC LIGHT BULBS

How to put your suppliers in your own "back yard"



It's like having all your suppliers right at hand, when you specify shipment by Air Express. Even coast-to-coast deliveries of supplies and parts are now routine. When you're in a rush for something, big or little, let Air Express solve your problem.

With more and bigger planes in service, Air Express schedules are more frequent. But the cost of this faster service is low. There is *profit* for you in the speed of Air Express, so use it regularly!

Specify Air Express—it's Good Business

- Low rates. • Special pick-up and delivery at no extra cost.
- Direct by air to and from principal U. S. towns and cities.
- Air-rail between 23,000 off-airline communities.
- Direct air service to and from scores of foreign countries.

Just phone your local Air Express Division, Railway Express Agency, for fast shipping action . . . Write today for Schedule of Domestic and International Rates. Address Air Express, 230 Park Avenue, New York 17. Or ask for it at any Airline or Railway Express Office. Air Express Division, Railway Express Agency, representing the Airlines of the United States.

AIR EXPRESS



GETS THERE FIRST

Rates are low

To Air Express an 18-lb. shipment 849 miles costs only \$4.42! Heavier weights — any distance — are similarly inexpensive. Investigate!



oratories. Dr. Cubb helped organize KDKA, holds over 150 patents including one on a position-finding technique (patented about 15 years ago) that is similar to loran, invented a chronograph using microwaves for measuring the velocity of projectiles, and assisted in development of methods for separating uranium isotopes.

Dr. Vannevar Bush, Chairman of the newly created Joint Research and Development Board of the Army and Navy received the Hoover Medal for 1946 in recognition of his outstanding public service. Dr. Bush was Director of the recent Office of Scientific Research and Development, is President of Carnegie Institute of Washington, and a member of the National Advisory Committee for Aeronautics. The annual award is made by the same engineering societies that make the John Fritz award.

Among the equipment seen on tours by members attending the meeting were an RCA Labs computer capable of solving ten equations simultaneously, synthetic crystals and radar developments at Bell Telephone Labs, and the television equipment used by CBS.

Joint Meetings

Conferences were held jointly with the American Mathematical Society, and the recently formed American Society for Quality Control. Quality control, utilizing techniques of gaging and testing, has become a primary factor in industrial production of uniform goods with minimum wastage.

At the joint conference on applied mathematics, Dr. Michel G. Malti of Cornell University, as chairman, commented on the welcome growing interest of mathematicians in scientific and engineering problems. Dr. John von Neuman of Princeton University, in discussing applications of high-speed computers, pointed out that in either an analogy computer, which converts quantities of the problem into directly analogous physical parameters that can readily be controlled (like electrical potentials) to obtain the solution, or the digital computer, in which an approximate numerical solution (such as graphical integration) is substituted for the actual problem,

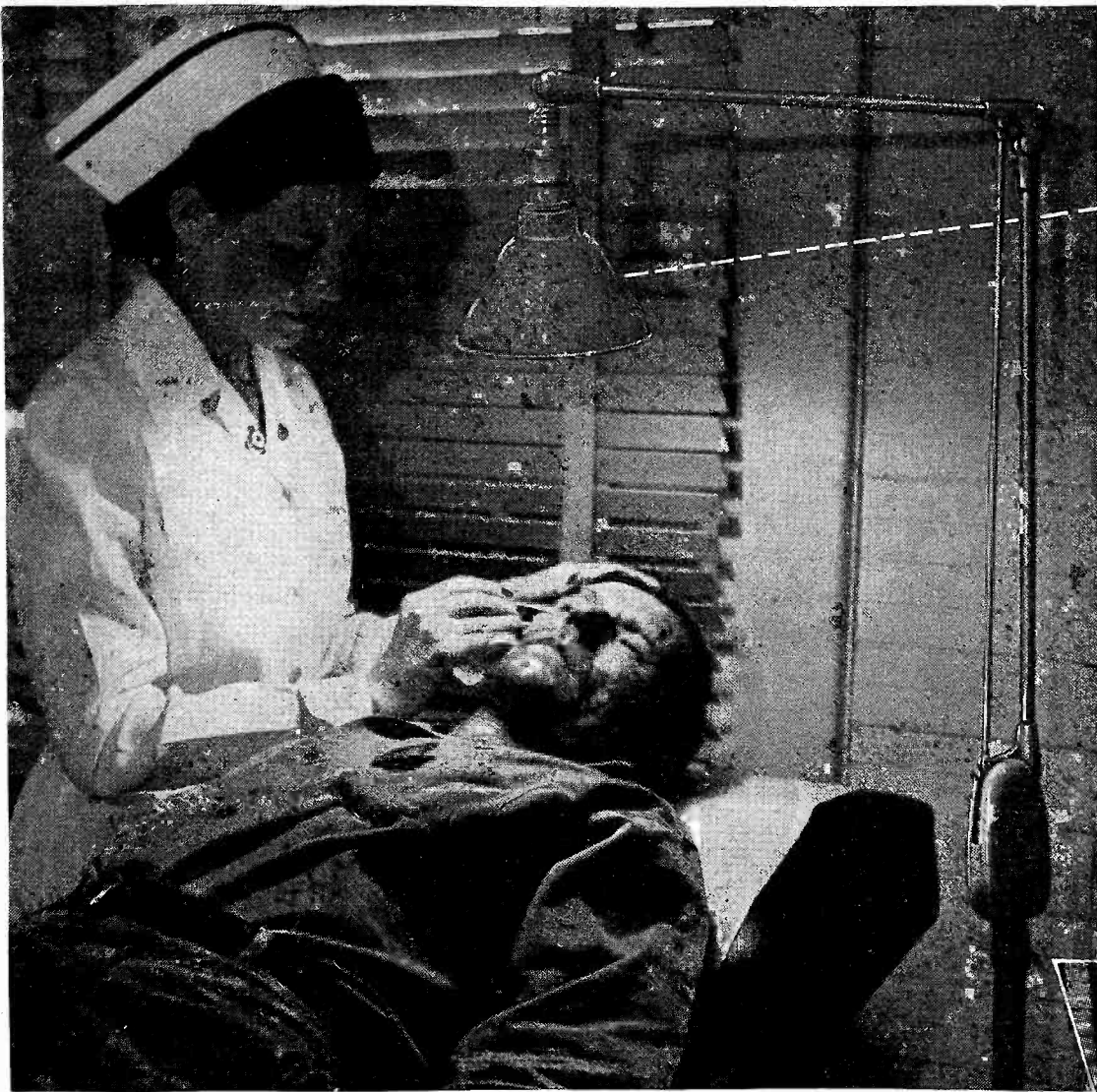

**PRODUCTIVE
LIGHTING
IS
Controlled
BY EACH USER
... FOR EACH
OCCASION**



Trained eyes and hands have an ally in the Dazor *Floating Lamp*, whether they're teamed in the first-aid room, at a high-speed machine or across an executive desk. By *floating* the light to the best position for seeing, the user completely controls intensity and position. And a finger-tip touch *changes* either, each time the job requirements change.

If you are accustomed to stationary lighting, or a lamp of restricted motion, the free movement of light in *all planes* will intrigue you. Dazor alone has the patented *Floating Arm* and its device for holding the reflector firmly, without locking or manual tightening.

But more important than the *how*

is the *why* of Dazor illumination. Employees who enjoy this comfortable, glareless lighting see fine details more clearly on machining, assembly, inspection, drafting and other exacting operations. As errors and hazards decline, there is a rise in morale. Special skills come to the front and productivity shows a gain.

Phone Your Dazor Distributor for typical applications by other users or an on-the-spot demonstration. For the name of this nearby lighting authority, if unknown to you, write to Dazor Manufacturing Corp., 4481-87 Duncan Ave., St. Louis 10, Mo. *In Canada* address inquiries to Amalgamated Electric Corporation Limited, Toronto 6, Ontario.



MOVES FREELY INTO ANY POSITION
AND STAYS PUT — WITHOUT LOCKING

DAZOR FLOATING LAMPS

FLUORESCENT and INCANDESCENT

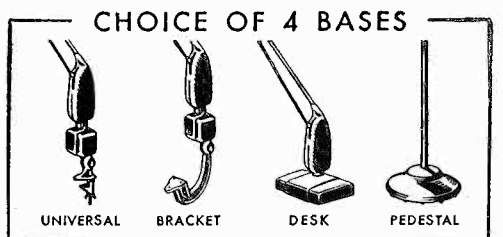



W I R E S

a t w o r k

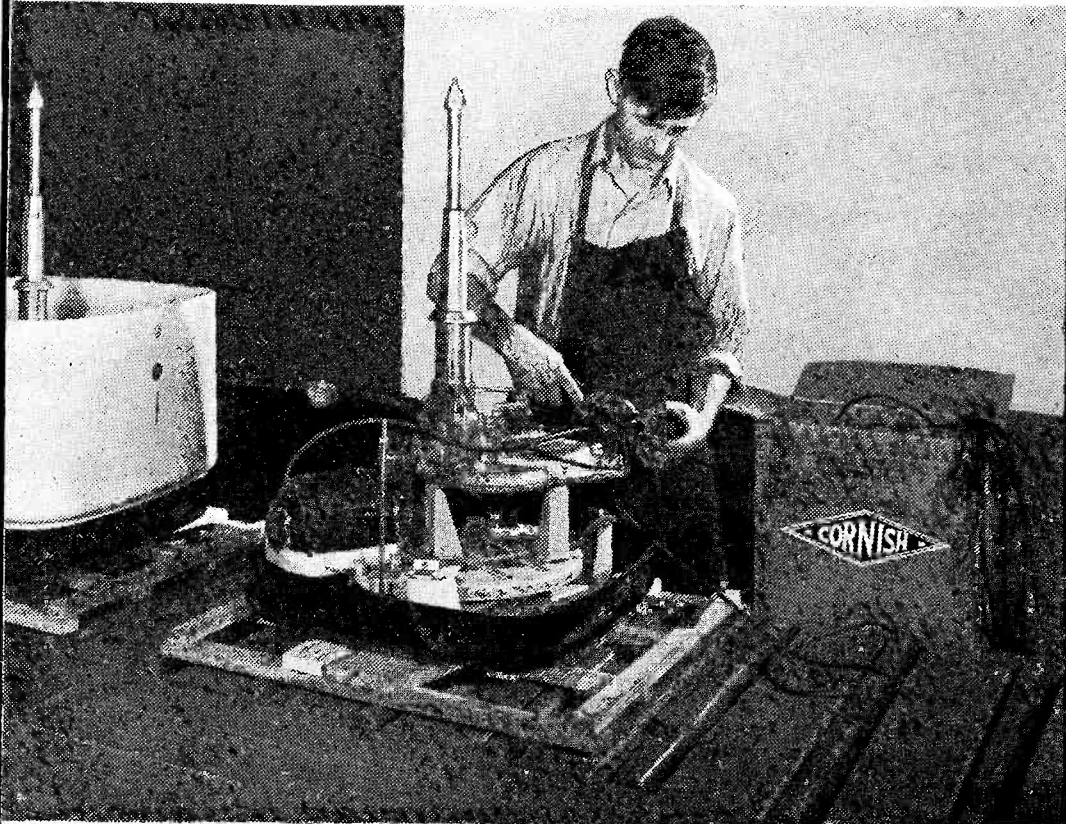

Courtesy HURLEY Machine Division, makers of THOR Washers

WHY ARE **CORNISH** WIRE PRODUCTS SPECIFIED BY THIS LARGE MANUFACTURER OF WASHING MACHINES?

Because their **ENGINEERING** Department knows by test that they will give faithful and enduring performance . . .

Because their **PRODUCTION** Department finds that they have those qualities essential for quick installation on their assembly line . . .

Because their **PURCHASING** Department realizes that these Quality Products, backed by dependable service, are sold at prices that spell true economy . . .

CORNISH WIRE CO., INC.

15 Park Row • New York City, 7

there is an inherent error. This error is the random noise in the analogy computer or the inability of the digital computer to carry numbers to their full places. The digital technique is intrinsically the better method of keeping the error small.

The one great difficulty of high-speed computers, said Dr. von Neumann, is the planning of the work to be done by the machine in solving problems. Next to this difficulty come those of getting data from physical measurements on which computers can operate, and of obtaining meaningful (humanly intelligible) answers (tables of numbers) from computers. One such problem, involving motion of a torpedo launched into the water at a low angle, suitable for high-speed computers was outlined by Dr. Garrett Birkhoff of Harvard University.

Probability as applied to electrical engineering was illustrated by Dr. Mark Kac of Cornell University. In the case of interpreting a radar return, if the signal is below noise level, one might either give a false alarm or be found negligent. Assuming noise to be completely random, the dependence of the probability of recognizing a return as a return on passbands of the various amplifiers and on the law of detection can be analyzed and a best design determined. The method of statistical analysis, illustrated by such a problem, can be applied in similar ways to other design considerations.

Use of a differential analyser in solving such engineering problems as transient mechanical stress in aircraft landing struts, starting large synchronous motors, non-linearity effects on range of current transformers, automatic operation of voltage regulators, and trajectories of electrons in vacuum tubes were described by C. Concordia of General Electric Co.

Large-Scale Computers

At a later session six computers in operation or nearing completion were described. Although the popular press has emphasized the speed with which automatic calculating machines can solve complex problems, mathematicians who use these machines emphasized the difficulty

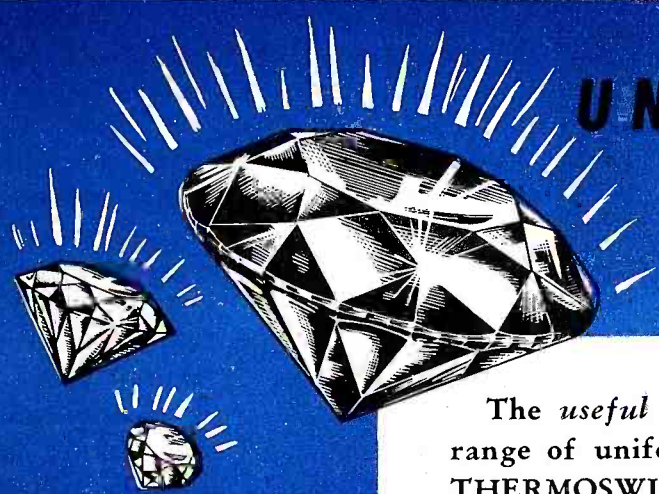

UNIFORMITY OVER WIDE TEMPERATURE RANGE*

The *useful* operating range of any thermostat is only as wide as its range of uniform response characteristics. The sensitivity of the Fenwal THERMOSWITCH Control is constant throughout its wide range of temperature settings. Careful selection of materials for THERMOSWITCH components on the part of Fenwal engineers insures maintenance of constant ratios of expansion or contraction at temperatures within the operating range — resulting in uniformly excellent control at any set-point. Its ability to function with equal efficiency at any setting within its 500° F. range means that a single THERMOSWITCH Control can be used in a great variety of applications.

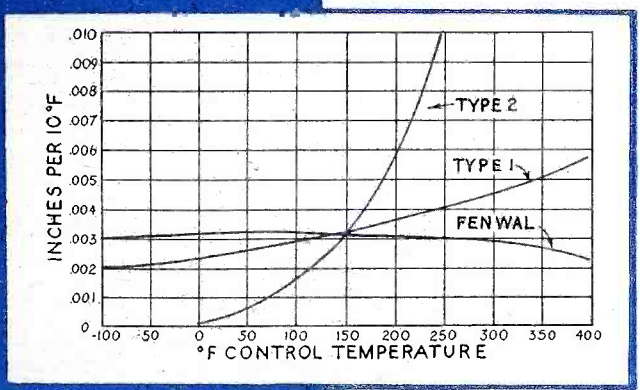
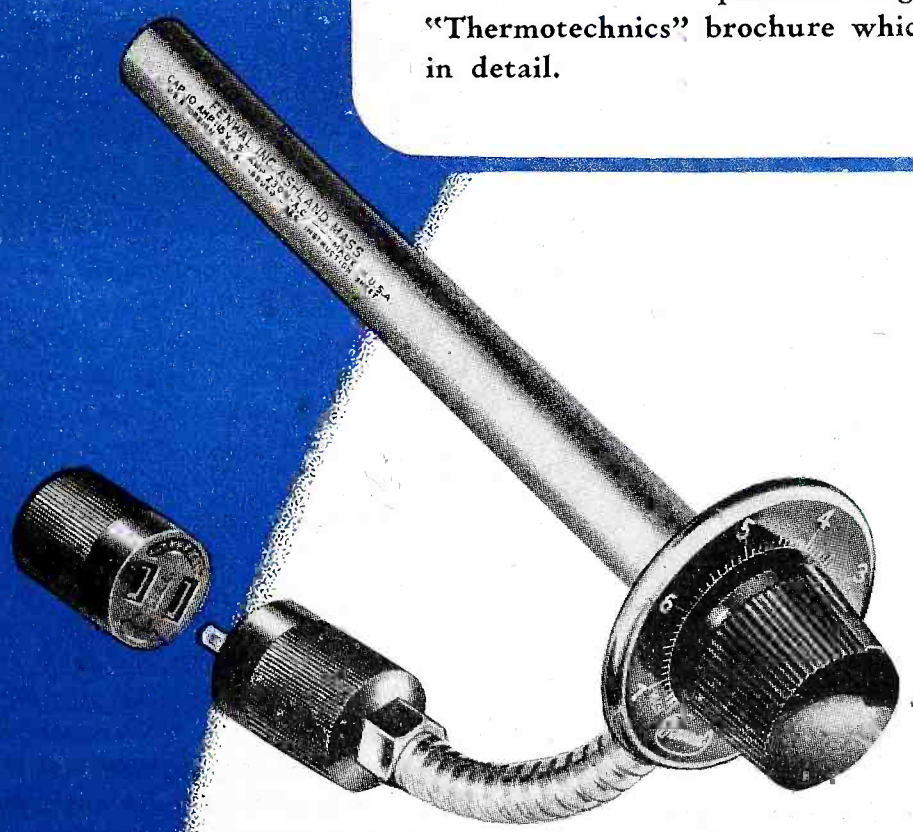

Chart shows the movement of thermostat electrical contacts per 10° F. change over a wide range of control temperatures. Note the uniform contact movement of the Fenwal unit compared to types 1 and 2 thermostats.

The Fenwal THERMOSWITCH Control has been termed the "ideal" thermostat by leading thermal control engineers because of its many desirable features. Fenwal units, combined with sound thermal engineering practice, are your best insurance of trouble-free temperature regulation and detection. Write for the

"Thermotechnics" brochure which describes THERMOSWITCH Controls in detail.

CONTACT MOTION PER 10°F



ALL-PURPOSE THERMOSWITCH CONTROL

- FOURTEEN FACTS IN FENWAL'S FAVOR**
- 1.—Fast reaction time
 - 2.—Large heat sensitive area, small heat storage
 - 3.—Short heat transfer path
 - 4.—Small temperature differential
 - 5.—Built-in temperature anticipation
 - 6.—Enclosed assembly
 - 7.—Minimal vibration effects
 - 8.—Tamper-proof and sealed
 - 9.—Rugged construction
 - 10.—Adjustable over wide temperature range
 - 11.—Minimum size
 - 12.—Directly responsive to radiant heat
 - 13.—Uniform sensitivity over adjustable temperature range
 - 14.—Readily installed

*#13 of the "Fourteen Facts in Fenwal's Favor"



FENWAL INCORPORATED
 43 PLEASANT STREET
 ASHLAND MASSACHUSETTS
 Thermotechnics for Complete Temperature Regulation

LABORATORY PRECISION —SHOP RUGGEDNESS

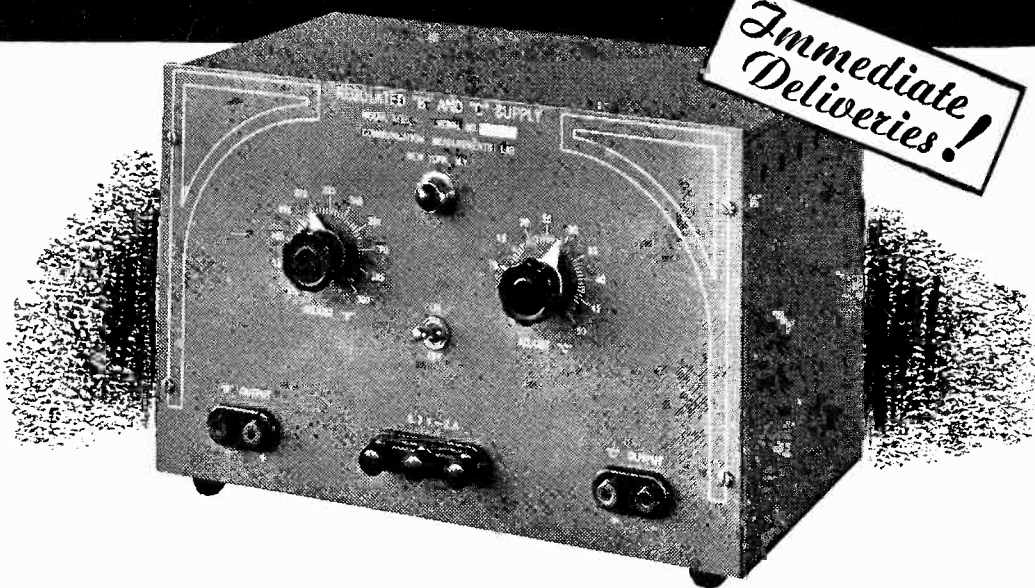

CML MODEL 1115 REGULATED POWER SUPPLY

● A thoroughly practical source of independently controlled and closely regulated "B" and "C" voltages for radio-electronic laboratory and factory uses. Includes convenient heater voltage to provide complete power source in a single unit. Front panel controls and output terminals facilitate rapid voltage adjustments and quick connections. Sturdily housed in a neat and compact steel cabinet. Insulated with an extra wide margin of safety. A "must" for the engineer who wants to save time and get things done!

ELECTRICAL CHARACTERISTICS

INPUT — 105-125 v., 50-60 cycles.

OUTPUT — "B" supply 150-300 v. — 70 mils. Ripple voltage less than 5 millivolts. Voltage regulation less than 1% — no load to full load.

"C" supply 0-50 v., zero current. Ripple voltage less than one milli-volt.

"A" supply, 6.3 v. at 5 amps., unregulated.

TUBES — 1-5U4G Rectifier, 2-6V6 series regulators, 1-VR75, 1-991, 1-6SJ7.

CML MODEL 1210 PORTABLE STROBOSCOPE

● This practical precision instrument provides a new, easy and speedy method of making slow-motion analyses of all mechanical devices that rotate, reciprocate or vibrate at either uniform or irregular rates. Also useful for dynamic stress and strain studies. Light-source probe has 4-foot cable radius. Compact and self-contained for on-the-job service.

Covers Speeds 450 to 60,000 RPM in 4 ranges.
Weight 19½ lbs.
10½" x 5¾" x 10½"

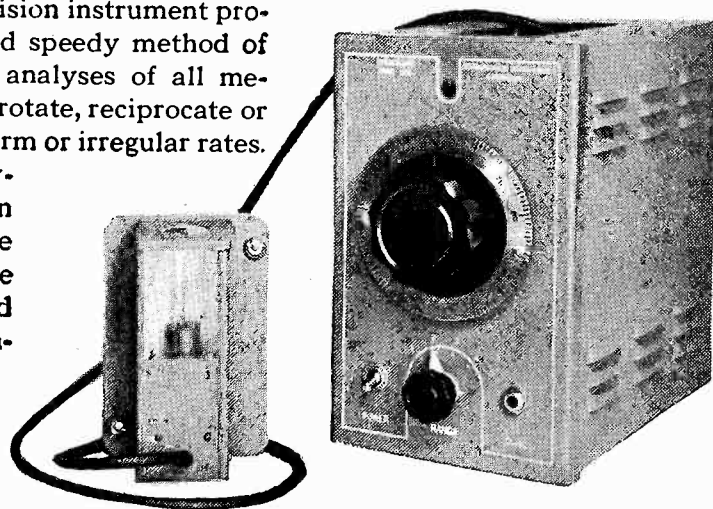

Write for prices and descriptive bulletins—today

of programming them before they are turned on. The computer performs arithmetical operations. The mathematician has to plan the sequence in which the computer performs these operations and the sources from which it draws each number for each operation and what it does with the result after each operation. Planning takes a mathematician who comprehends the mathematical logic behind the solution. One present serious handicap in the utilization of large-scale computers is the lack of adequate mathematicians to plan the work that the computers are to perform.

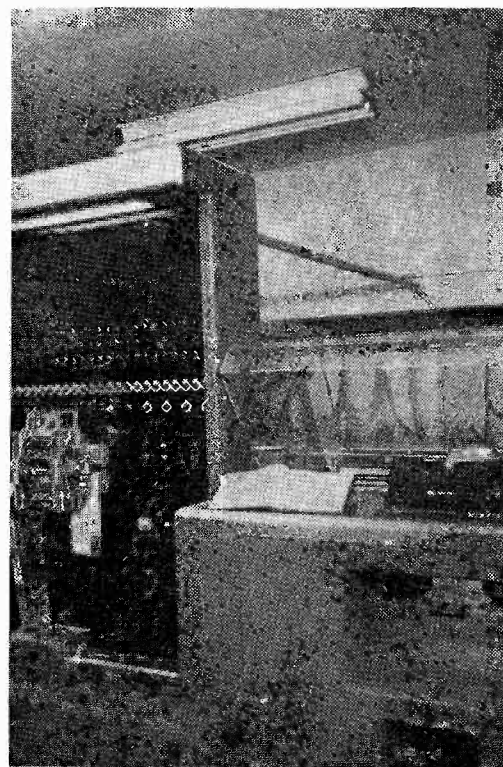

Portion of Harvard's calculator showing preparation of control tapes

The use at Harvard University of the IBM automatic-sequence controlled calculator was described by H. H. Aiken. The calculator does numerical calculations in a pre-arranged, controlled sequence. It can refer to tables, interpolate, and perform other numerical operations. Problems involving statistics and integrations that it is to solve must be reduced to numerical manipulations. This conversion of the problem into numerical form requires a staff of mathematicians. Once in numerical form the problem is coded for the machine by perforating three groups of eight three-digit numbers on a tape. The first group tells the machine where to obtain numbers, the second group tells it where to put the result, and the third group tells it what trans-



**COMMUNICATION
MEASUREMENTS
LABORATORY, INC.**

REctor 2-2080

Cable Address: "COMUNILAB" NEW YORK

120 GREENWICH STREET • NEW YORK 6, N. Y.

YOU GET QUALITY PLUS ENGINEERING SERVICE WITH G-E PERMANENT MAGNETS

THE MAGNET WITH A VOICE

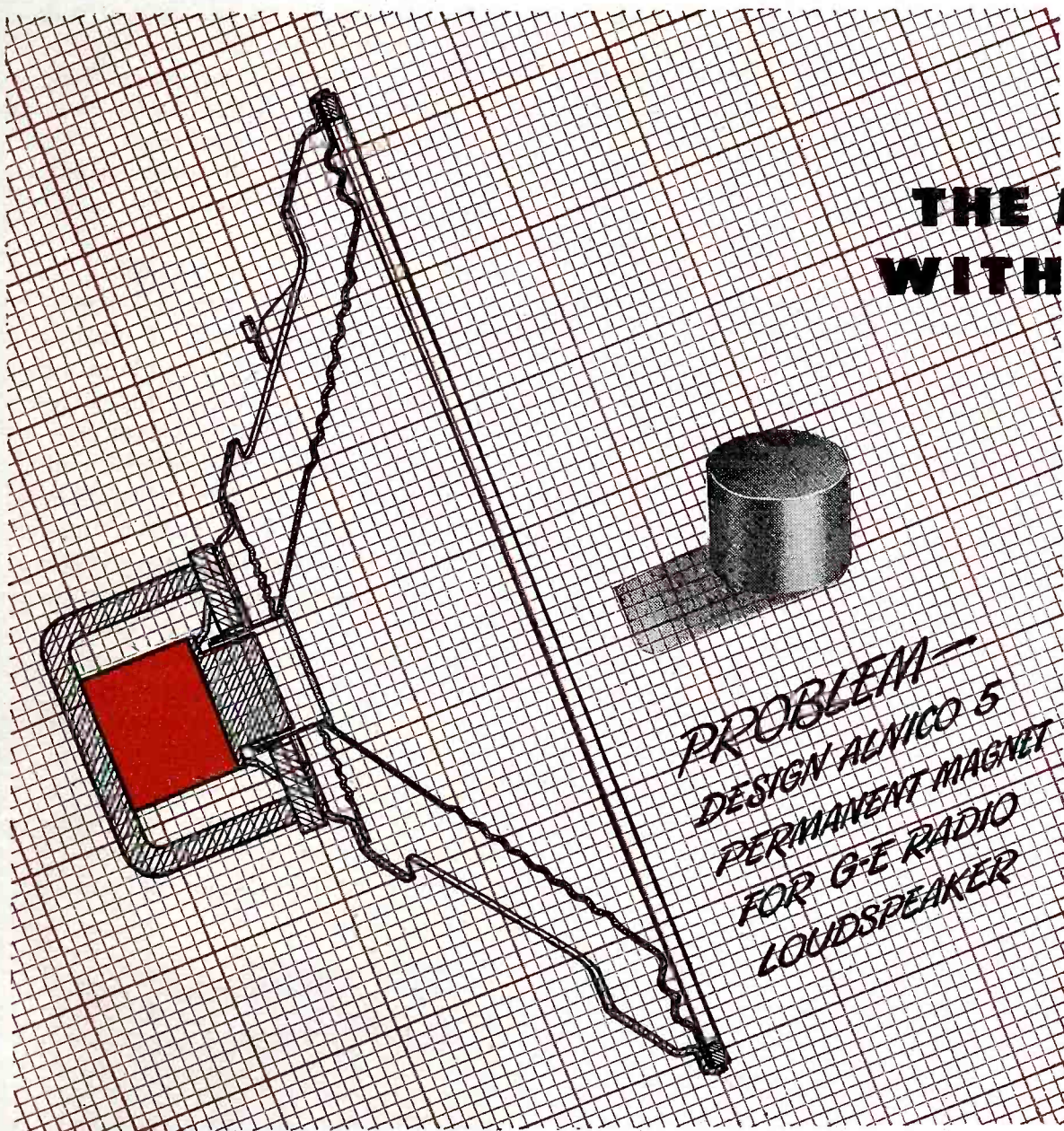

*PROBLEM—
DESIGN ALNICO 5
PERMANENT MAGNET
FOR G-E RADIO
LOUDSPEAKER*



A voice coil wound on an aluminum base moving in the field of an ALNICO 5 permanent magnet—that's the heart of the modern G-E loudspeaker. Current passing through the coil in the magnetic field causes the coil and attached cone to vibrate in proportion to the applied alternating voltage, thus producing sound waves. ALNICO 5 offers maximum energy with reduced size and weight, minimum losses and increase of sensitivity and power.

General Electric's precise quality control methods used throughout magnet production, plus accurate testing and rigid inspection assure you of receiving magnets of the highest uniform quality for your application.

Greater flexibility of magnet design is possible with the many G-E permanent magnet materials now available. The large group of sintered and cast ALNICO alloys has been augmented by the lightweight, non-metallic mixture, VECTOLITE, and by the ductile permanent magnets, CUNICO, CUNIFE and SILMANAL. From such a wide choice of materials, you may now find a magnet better suited for your application or a material which will make possible new designs heretofore impractical or impossible.

General Electric engineers, backed by research and application experience, have acquired years of "know-how" in selecting the best permanent magnet material and properly designing magnets for thousands of products. These engineers are at your service. *Metallurgy Division, Chemical Dept., General Electric Co., Pittsfield, Mass.*

SEND FOR NEW BULLETINS ON G-E PERMANENT MAGNETS

We shall be glad to send you upon request our new bulletins, CDM-1, "Permanent Magnets," and CDM-2, "Cast and Sintered Alnico, Catalog Supplement," both specifically designed to help you with your permanent magnet problems.

CDM-1 contains information about the characteristics and properties of G-E permanent magnet materials, their application and design. Listed in the catalog supplement, CDM-2, are sintered and cast Alnico permanent magnets available from stock. Proposed R.M.A. standard speaker magnets are included.

For your copies, please fill out the coupon below.

METALLURGY DIVISION
SECTION FA-4
CHEMICAL DEPARTMENT
GENERAL ELECTRIC COMPANY
PITTSFIELD, MASS.

Please send me your new bulletins, CDM-1 and CDM-2, on G-E Permanent Magnets.

NAME.....
TITLE.....
COMPANY.....
ADDRESS.....
CITY..... STATE.....

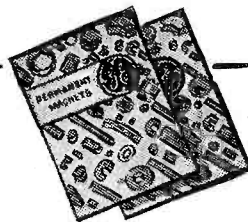

**PERMANENT
MAGNETS**

GENERAL ELECTRIC

CD47-JA3

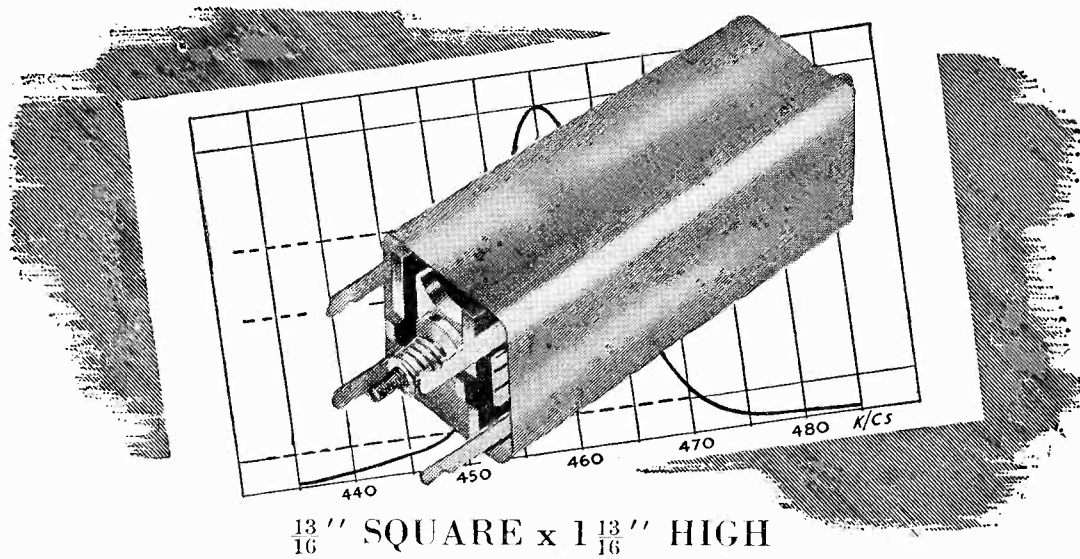

1 13/16" SQUARE x 1 13/16" HIGH

BIG QUALITIES

... PACKED SMALL

The finest materials and modern production technique go to the making of this I.F. Transformer by Wright & Weaire. It passes all tests for reliability with ease, whilst its small overall measurements promote it first choice for all equipment where layout space is valuable. Only brief details can be given here, so write to-day for full particulars. Prompt deliveries can be guaranteed.

SPECIFICATION

Primarily designed for use with valves of the I.R5, I.T4 and I.S5 Series. High gain and selectivity with stability are obtainable. Permeability tuning is employed with enclosed type cores and the necessary fixed condensers 'built in'. Coils are impregnated and can be used with

confidence in the tropics. Available in the following preferred frequencies with various degrees of coupling:—460 Kc/s, 1.6 Mc/s, 2.1 Mc/s, 4.86 Mc/s. The response curve shown is for Type M400 and is typical of the whole series. Nominal frequency is 460 Kc/s but is adjustable from 420 to 530 Kc/s approx.



MINIATURE I.F. TRANSFORMERS

WRIGHT & WEAIRE LTD., 740, HIGH ROAD, TOTTENHAM, LONDON, N.17, ENGLAND. CABLES: WRITWEA, LONDON
FACTORY: SIMONSIDE WORKS · SOUTH SHIELDS · CO. DURHAM · ENGLAND

★ This Trade Mark is well-known in Britain as that of a Company who are responsible for the Design, Development and Manufacture of Transformers, Vibrators, Switches and Coils. This particular component of real miniature dimensions, yet maintaining highest efficiency, is the latest development of their Engineering Dept. and is backed by 26 years experience in the manufacture of Radio and Electronic components.

fer operation to perform on the numbers taken out before putting them back. This sequence constitutes one numerical operation. Subsequent operations are performed from like instructions. The machine carries out instructions faster than they could be made manually (a table of Bessel functions can be printed by the machine faster than pages can be proof-read), so several teams of mathematicians are kept at work planning problems and preparing tapes to keep the machine in constant use.

Tapes represent the method and are independent of numerical values used in problems, so once a tape has been prepared for a particular type of problem, that problem, with different values, can be quickly solved. But as the time to prepare the tape is a major portion of the total time to obtain a solution, it is not feasible to solve problems on the calculator unless solutions for many sets of data are required. The machine has been used for such problems as calculation of radar antenna patterns.

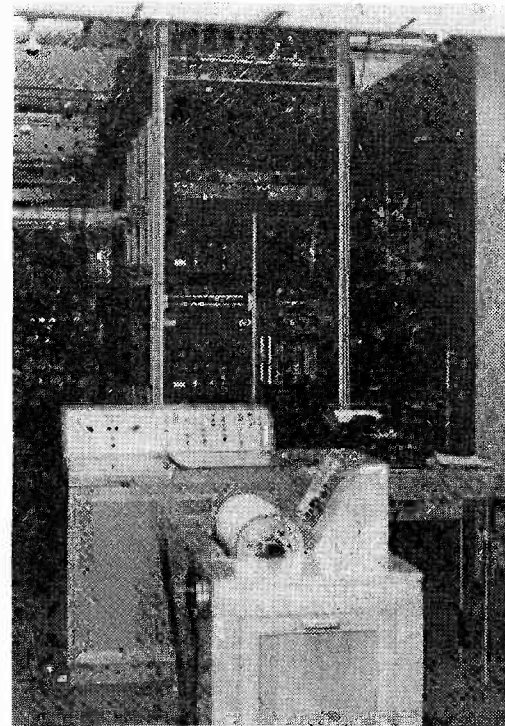

MIT's differential analyzer is one of the earlier electronic calculators

The thinking that goes into the design of a computer was presented by Julian Bigelow of Princeton University. From what he said it is evident that computers, far from popular misconception of making possible solutions of problems heretofore insolvable, require mathematicians to think through beforehand all the types of manipulations necessary for solution of

...a metal for inserts that won't work loose from ceramic insulation as temperatures fluctuate.

Mycalex Corp.

...a metal to hold other parts in place under the searing heat of a high-voltage discharge.

General Electric Co.

...a metal that won't develop high surface resistance because of corrosion.

Vendo Corp.

...a metal whose electrical resistance varies measurably with temperature changes.

The Simmons Co.

...a metal for an armature that vibrates continuously 94,000,000 times a year.

Union Switch and Signal Co.

...a metal that can stand spark erosion without pitting or burning.

Scintilla Magneto Co.

...a metal that will remain non-magnetic during spot-welding.

General Thermostat Corp.

THESE ARE TYPICAL METAL SELECTION PROBLEMS THAT WERE SOLVED BY USE OF

**MONEL
NICKEL
INCONEL**

	MONEL	"R" MONEL	"K" MONEL	"KR" MONEL	"S" MONEL	NICKEL	"Z" NICKEL	INCONEL
CORROSION RESISTANCE	HIGH	HIGH	HIGH	HIGH	HIGH	HIGH	HIGH	HIGH
STRENGTH	GOOD	GOOD	HIGH	HIGH	GOOD	GOOD	HIGH	GOOD
TOUGHNESS	GOOD	GOOD	HIGH	GOOD	GOOD	HIGH	HIGH	HIGH
HARDNESS	GOOD	GOOD	GOOD	GOOD	HIGH	FAIR	HIGH	GOOD
MACHINABILITY	GOOD	HIGH	GOOD	HIGH	GOOD	GOOD	GOOD	GOOD
NON-GALLING	NO	NO	NO	NO	HIGH	NO	NO	NO
SPRING PROPERTIES	GOOD	NO	HIGH	NO	NO	GOOD	HIGH	HIGH
ELEC. CONDUCTIVITY	POOR	POOR	POOR	POOR	POOR	GOOD	GOOD	POOR
HEAT RESISTANCE	GOOD	GOOD	GOOD	GOOD	HIGH	GOOD	GOOD	HIGH
HEAT TREATABLE	NO	NO	YES	YES	YES	NO	YES	NO
NON MAGNETIC	NO	NO	YES	YES	YES	NO	NO	YES

Think of the INCO Nickel Alloys first when you need a metal with a hard-to-find combination of properties.

These high-Nickel alloys are Strong... Tough... Hard... Rustless. They resist High Temperatures... Corrosion... Wear... Fatigue. Their use is insurance for long, trouble-free service.

MORE INFORMATION! Tell us the alloy that interests you, and we'll mail more information. Or, send for "List B-100" which lists over 100 bulletins explaining the properties and applications of the INCO Nickel Alloys.

THE INTERNATIONAL NICKEL COMPANY, INC.
67 Wall Street, New York 5, N. Y.

NICKEL  **ALLOYS**

MONEL* • "K" MONEL* • "R" MONEL* • "KR" MONEL*
"S" MONEL* • INCONEL* • NICKEL • "L" NICKEL* • "Z" NICKEL*
*Reg. U. S. Pat. Off.

**ATTENTION
INSTRUMENT
MANUFACTURERS**

**File your rectifier
specifications with
Conant *Now!!***

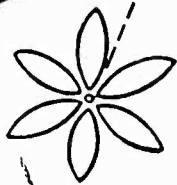

"Specials" have always been a Conant specialty. Conant designs and laboratory production methods permit the production of special rectifier assemblies at regular prices.

If your specifications are on file at Conant, you can be sure of receiving rectifiers which will fit the job.

Your specifications must contain the following information:

- 1 The maximum range of forward resistance at a definite value of current.
- 2 The maximum inverse current per disc.
- 3 The ambient temperature at which above values are to be measured.
- 4 A definite statement of the method used to make the above measurements and a schematic of your test circuit.

The above can then be interpreted to fit Conant test methods.



Instrument Rectifiers

ELECTRICAL LABORATORIES

6500 O STREET, LINCOLN 5, NEBRASKA, U. S. A.

20 Vesey St., New York 7, New York 518 City Bank Bldg., Kansas City 8, Mo. 1526 Ivy St., Denver, Colo.
85 E. Gay St., Columbus, Ohio 1212 Camp St., Dallas 2, Texas 4214 Country Club Dr., Long Beach 7, Cal.
600 S. Michigan Ave., Chicago 5, Ill. 378 Boulevard N. E., Atlanta, Ga. Export Div., 75 West St., New York 6, N. Y.
1215 Harmon Pl., Minneapolis 3, Minn. 4018 Greer Ave., St. Louis, Mo. 50 Yarmouth Rd., Toronto, Canada

problems for which the computer is to be used. The first consideration is to simplify programming and setting-up of computer problems.

Components of a computing machine are: input, memory, arithmetic manipulator, control, and output. Memory of the Princeton machine will consist of an external unit that records what is to be remembered on a magnetic tape, and an internal unit consisting of an image storage tube modified to meet special requirements of computers. Magnetic tape provides an indefinitely long memory for such quantities as tables of functions to which the machine can refer, while electronic memory provides short time storage for numbers obtained from one arithmetic operation and shortly to be used in another one. Although magnetic tape provides storage of many numbers in very small space, it lacks the desirable feature of being readable instantly at any point. Such an instantly readable memory is needed for high-speed machines.

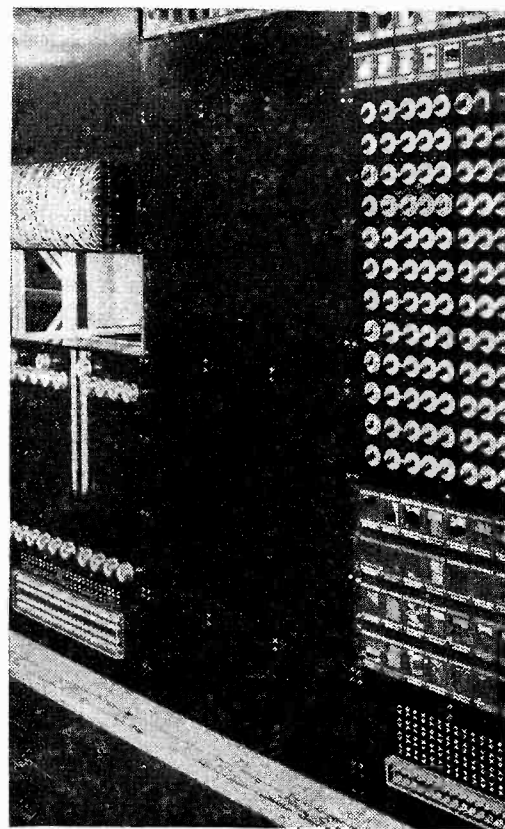

Universal computers must be adaptable to all types of problems

Although it will take about three years to complete the project, J. W. Forrester of Mass Inst of Tech described an all-electronic computer. The machine is planned to fill needs of pure and applied science, engineering, and statistical studies such as those made by the U. S. Bureau of the Census. Such com-

FACTS ABOUT

Irvington Silicone Varnished Fiberglass*

You can immediately secure Silicone Varnished Fiberglass electrical insulation which meets the property values listed:

TYPICAL TEST DATA

	.004"	.007"	.010"	.012"
Nominal Thickness	100	135	175	175
Tensile Strength — lbs. P.I.W.	.27	.47	.66	.77
Weight per sq. yd. — lbs.	1.42	1.42	1.41	1.41
Specific Gravity	1500	1500	1400	1300
Dielectric Strength — V.P.M.	1000	1000	900	900
1/4" Electrodes — A — ASTM — 25°C.	1.0	1.0	1.0	1.0
1/4" Electrodes — A — ASTM — 175°C.	1.3	1.3	1.4	1.4
Power Factor — 100°C. — Percent	3.5	3.5	3.4	3.4
Conditioned 3 hours at 105°C.				
Conditioned 24 hours at 65% R.H.				
Dielectric Constant — 100°C.	0.01	0.01	0.015	0.015
Moisture Resistance	0.70	0.60	0.55	0.55
%H ₂ O absorbed — 24 hrs. 65% R.H.				
%H ₂ O absorbed — 24 hrs. immersion				
Thermal Stability — Tests made on Silicone Varnished Fiberglass indicate that this material is stable up to 175°C.				
Chemical Resistance: Silicone Varnished Fiberglass shows excellent resistance to most alkalis, such as 10% sodium hydroxide and concentrated ammonium hydroxide. A 10% solution of HCl and nitric acid showed no effect on Silicone Varnished Fiberglass.				
Carbon tetrachloride, benzene and hot transformer oil (GE 10C) cause a softening of the Silicone varnish film.				

THICKNESSES AND WIDTHS: Silicone Varnished Fiberglass is available in the following standard thicknesses: .004" (.002" base), .007" (.003" base), .010" (.004" base), .012" (.004" base). Standard full width rolls are

36" wide and 25 and 50 yards long. Also furnished in strips 51" long. Thicknesses other than standard are supplied on minimum orders of 100 yards.

*T. M. Reg. U.S. Pat. Off. by Owens-Corning Fiberglass Corporation

● For slot insulation, coil and cable wrapping — for high frequency equipment, transformers, and generators — for relays, rheostats, and resistors — as well as for a host of other electrical parts subjected to elevated temperatures, Silicone Varnished Fiberglass is unequalled. Investigate its use for your insulation problems. Write today for samples.



IRVINGTON

VARNISH & INSULATOR CO.

Irvington 11, New Jersey

**Now Know Power fed to Antenna
while operating**

ROLLIN

VHF - UHF **RF**
WATTMETER
MEASURES
POWER • IMPEDANCE
SWR

70 MC TO ABOVE 400 MC

**DIRECT
INDICATION
OF POWER
AND SWR**

**NOT
ABSORPTION
TYPE**

**GENERAL
LABORATORY
USE**

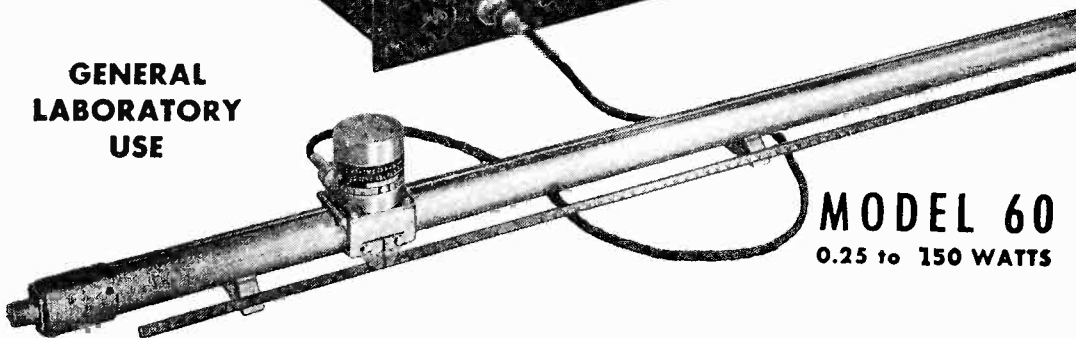
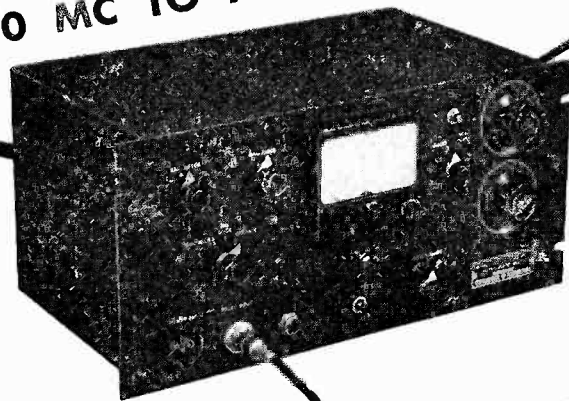

MODEL 60
0.25 to 150 WATTS

- Measures power flowing through transmission line to antenna under wide range of standing wave conditions and antenna impedances.
- Direct reading meter with 4 calibrated ranges; 0.25-5, 5-15, 15-50 and 50-150 watts. Meter has adjustable reference pointer for noting any change in power.
- Precision 50 ohm slotted line with solid dielectric, type N connectors and centimeter scale.
- Accurate step type wire wound controls indicate standing wave ratio (SWR).
- Model 60 is a complete set of equipment for impedance measurements by slotted line method (only r.f. power source required).

Write for details . . .

ROLLIN

THE ROLLIN COMPANY
2070 N. FAIR OAKS AVENUE • PASADENA 3, CALIFORNIA

puters, in addition to being arranged for solution of any problem from data supplied to it, can be simplified for solution of specific problems encountered in industrial processing, in which case the calculator would be built into the industrial control equipment and would serve to control complex operations in accordance with data supplied to it from plant instrumentation.

Among functions to be provided in a computer is that of choice between possible computing programs. For example, the machine should be able to cycle to within a given limit of convergence when handling nonlinearities, and then proceed to the next step in the solution. High speed (50 microsec to multiply two 12-digit numbers) is useful when computing cycles must be frequently repeated. Instead of sequential transmission of numbers to parts of the computer as used in other machines, this machine transmits 40 digits of a number simultaneously over parallel busses (see later about ENIAC). Circuit problem thus introduced is one of precisely gating each train of pulses to the proper unit of the computer. Wide bandwidth is required with low noise, but at the same time circuits are made to pass d-c so that manual programming can be used for locating faults in the machine. The memory is to utilize electronic storage on a dielectric plate.

Reviewing what has been done to provide industry with computers, J. C. McPherson of IBM Corp explained how basic units of business machines controlled by punched cards have been available to engineering computations offices. One such unit is electronic, handling multiplications of one six-digit number by another in 17 microsec.

The ENIAC, described by T. K. Sharpless of the University of Penna as the largest automatic tube tester in constant use, was planned for the specific purpose of preparing ballistic firing tables (ELECTRONICS, p 308 April 1946). A general purpose computer EDVAC, is being developed. It has greater memory facilities, fewer tubes, but does not perform operations quite so fast because it uses time sequence (or division) rather than the spatial division of the ENIAC. Thus, instead of having a multi-

A new principle

SPECIFICATIONS

VOLTMETER

Ranges: .015, .05, .15, .5, 1.5, 5, 15, 50, 150, 500, 1500 volts full scale.

Input Impedance: 1 megohm on all ranges with exception of 1500 Volt scale, where the impedance is 3 megohms. This gives a sensitivity of 68 megohms/volt on lowest range.

MICROAMMETER

Ranges: .015, .05, .15, .5, 1.5, 5, 15, 50, 150, 500 microamps full scale.

Voltage Drop: Maximum .15 volts. On lower ranges it drops to .045 volts.

Ohmmeter: Resistance can be determined by measuring E & I from any external power supply. With 500 volts, 67,000 megohms give half scale reading on maximum range.

Power Requirements: 115 volts, 60 cycles, 175 watts.

FOR THE MEASUREMENT OF D. C. VOLTAGE ...

SHERRON D. C. Vacuum Tube Voltmeter-Ammeter

D. C. Current is instantly converted to alternating voltages of a fixed frequency — amplified and metered. With the use of this principle, even the minutest flow of direct current can be read. The extreme sensitivity of this advanced instrument heightens its value. A versatile instrument, Model SE-519 has further application as a megohmmeter with external voltage source.

SHERRON ELECTRONICS CO.

Division of Sherron Metallic Corporation

1201 FLUSHING AVENUE • BROOKLYN 6, NEW YORK



Model SE-519

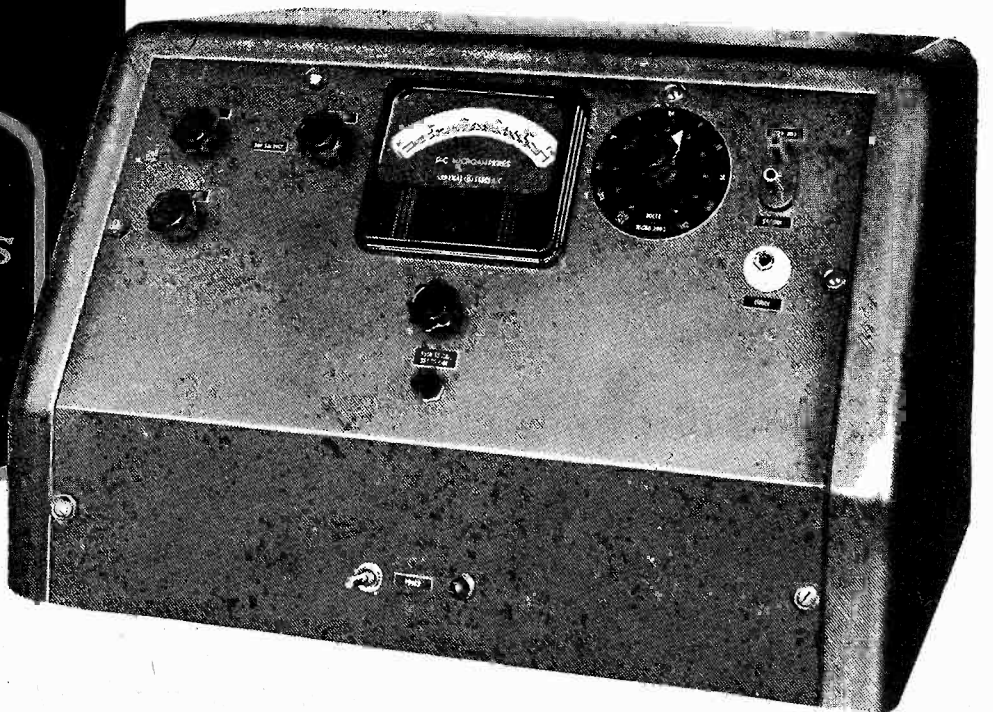

plicity of circuits through which signals pass in parallel, the EDVAC has a few circuits through which signal pass in tandem. Coding will be by magnetic tape coded at slow speed and run through the electronic calculator at high speed.

A relay-operated computing machine developed by Bell Tel Labs was described and illustrated by S. B. Williams, consulting engineer. Controlled by a punched tape (perforated by a teletypewriter), the machine adds, subtracts, multiples, divides, and extracts square roots of real or complex numbers and prints results on teletypewriters. Other mathematical operations are performed by combinations of these basic manipulations. Should the computation called for by the control tape not be completed in the allotted time, the machine stops and signals a fault. The serviceman can then see from the fault indication in what part of the machine the calculation has been interrupted and go there and repair the offending relay. Computation then proceeds without loss or repetition.

Problem of accuracy of calculations performed by automatic machines was outlined by John Mauchly of the Electronic Control Co. Inaccuracies produced by rounding off in digital machines introduces errors whose magnitudes are difficult to estimate. The machines themselves can be used to determine their truncation errors by, for example, solving the same problem by several methods, which is feasible with machine computers where cost of computation is low.

Energy Sources

Beginning a series of conferences to examine systematically possibilities of utilizing all possible sources of electrical energy to their fullest extent, a conference was held by the Committee of Basic Sciences. A brief survey of means of converting other forms of energy into electrical energy was presented in a report prepared jointly by L. W. Matsch of the Armour Research Foundation and Wilbur C. Brown of the U. S. Signal Corps. There are electromagnetic methods, which include such rotating machinery as d-c and a-c generators; there are electrochemical means, which embraces the wide variety of primary and

don't say

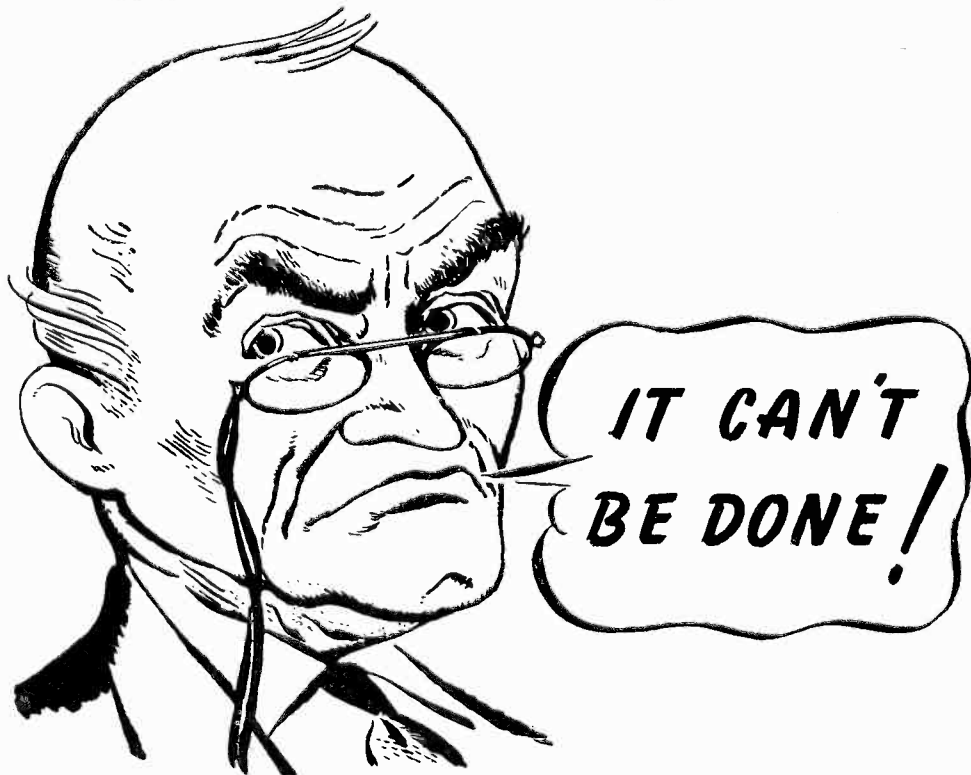

COTO-COIL Has Done It for 30 Years

Ingenious Methods

Produce Coils More Cheaply

We can assure lower costs because we specialize . . . because our equipment includes the newest and best machines . . . because we have the "know how" which comes from long years of experience. Coto-Coil costs reach lowest levels for high quality windings.

If You Manufacture

Electronic Equipment—Industrial Controls—Automobile or Aviation Equipment—or other products embodying coils, we can help you improve efficiency and lower costs.

Let us figure on your particular requirements.

COTO-COIL CO., INC.

COIL SPECIALISTS SINCE 1917

65 PAVILION AVE.

PROVIDENCE 5, R. I.

Some examples of what can be done with Whistler Adjustable Dies. Work in practically any type press.

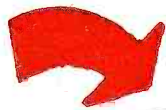

Re-use same **WHISTLER** ADJUSTABLE DIES in unlimited combinations

- 1** To Pierce Holes of any diameter from $\frac{1}{32}$ " up.
- 2** To Perforate Special Shapes.
- 3** To Notch Corners.

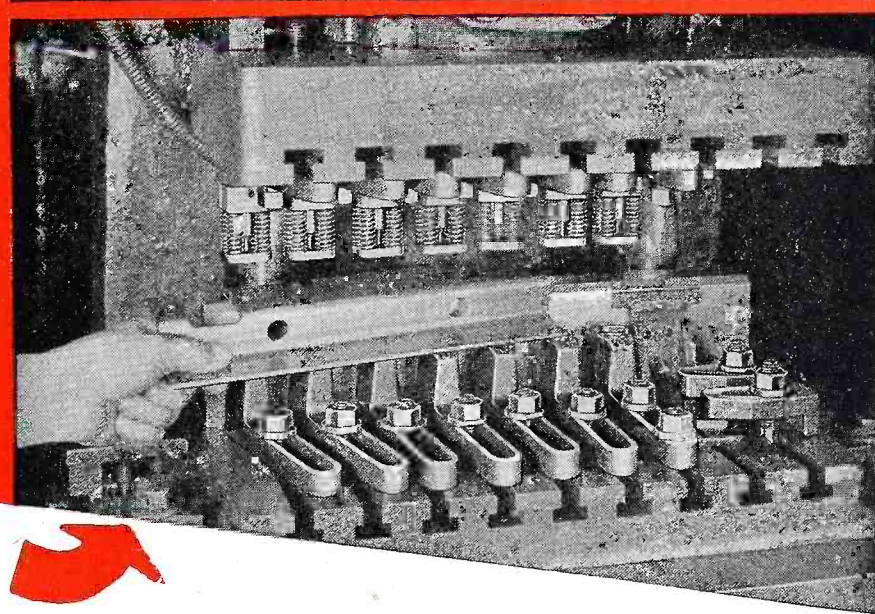
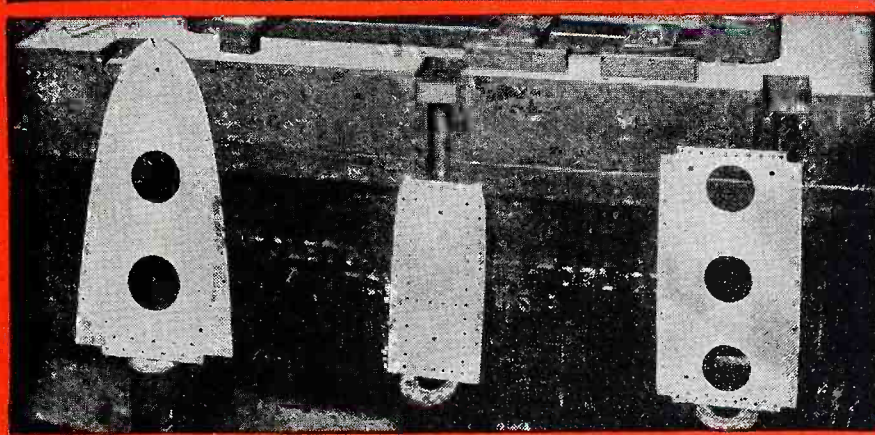
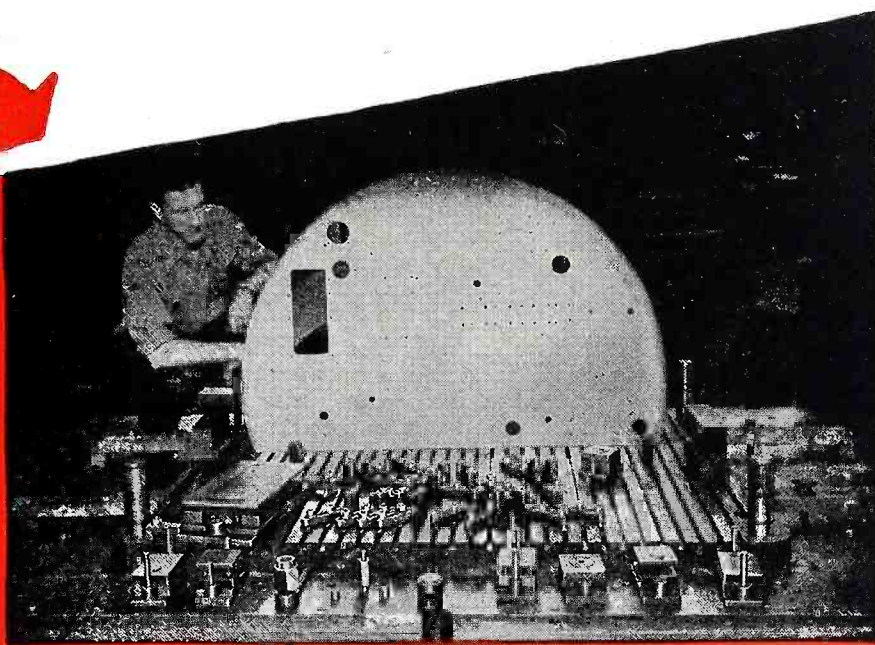

Save production time and reduce product costs by having Whistler punch and die units in your tool room.



Whistler notching dies, group dies and standard units are especially adaptable to combined use in the same set-up. Continued re-use in a variety of arrangements quickly writes off original investment. Reason enough for their expanding popularity with hundreds of America's best known manufacturers.

Now available from stock in a range of diameters up to 3", shipment can be made the same day your order is

received. Special sizes, shapes, notching and group dies are made to order in a few days.

You get production economy plus precision perforating in practically any press with these Whistler dies. Set-ups are easy and fast. No special tools required. Heavy duty series easily pierces $\frac{1}{4}$ " steel. All parts interchangeable. Tolerances maintained to .0002". There are many other advantages. Get in touch with Whistler.



WRITE FOR YOUR WHISTLER CATALOGS. Know the production advantages of Whistler Adjustable Dies.

S. B. WHISTLER & SONS, INC.
752-756 MILITARY ROAD BUFFALO 17, NEW YORK

Outstanding developments produced by pioneer and leader in this field

Brush Plated Wire

- ✓ Constant plating thickness assures uniform signal
- ✓ Correct balance of magnetic properties assures good frequency response and high level
- ✓ Excellent surface finish assures low noise and minimum wear
- ✓ Corrosion resistant
- ✓ Easy to handle—ductile—can be knotted

Brush Paper Tape

- ✓ Easy to Handle
- ✓ Extremely low-cost
- ✓ Can be edited . . . spliced
- ✓ Greater dynamic range
- ✓ Minimum wear on heads
- ✓ Excellent high frequency reproduction at slow speed
- ✓ Permanent—excellent reproduction for several thousand play-backs

**New Brush Magnetic
Recording tape and wire offer
LOWER COST . . . UNIFORMITY
. . . EXCELLENT FIDELITY**

Vastly improved tape and wire recording heads and cartridges

Another important improvement made by Brush has been the development of very simply constructed, low-cost erasing, recording and reproducing heads. Of principal interest are their excellent electrical characteristics, extreme simplicity of design to avoid trouble, and the "hum-bucking" characteristics which reduce the effect of extraneous magnetic fields. When required, the head cartridge alone (pole piece and coil unit) may be supplied for incorporation into manufacturers' own head structure.

These latest developments in magnetic recording equipment can now be obtained for radio combinations and other uses. Brush engineers are ready to assist you in your particular use of magnetic recording components.



The new
Brush wire
recording head

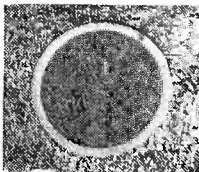

Cross section
of Brush
plated wire

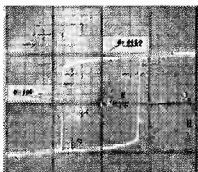

Hysteresis
loop of Brush
plated wire

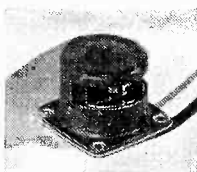

The new
Brush tape
recording head

THE BRUSH DEVELOPMENT CO. 3405 Perkins Ave.
Cleveland 14, Ohio

Write today for further information

secondary (storage) batteries; the electrostatic; the thermo-electric (depending on temperature differences between two junctions of dissimilar metals in a closed circuit); thermomagnetic (in which reluctance of a magnetic circuit is changed by thermal expansion or contraction of elements in that circuit); magnetostrictive (wherein reluctance of a magnetic circuit is changed by mechanical forces); piezo-electric and pyro-electric, production of electric polarity in a crystal, being by pressure in the former and by temperature by the latter; emission, either thermionic or photo-electric; contact (where, when two dissimilar metals are in contact, they become differentially charged; atmospheric (the potential gradients in the atmosphere); and terrestrial (earth currents). All of these phenomena are known, but only the electromagnetic and electrochemical ones have been used extensively for power, while some of the others are not understood.

Emission phenomena, on which the electronic branch of electrical engineering depends, was described by Dr. L. A. DuBridge of Calif Inst of Tech. Dr. Walter G. Cady of Wesleyan University (ELECTRONICS, p 290 Oct. 1946) reviewed piezo-electricity and the related phenomena of pyro-electricity. Possible expansion of the application of electrostatic phenomenon was predicted by John G. Trump of Mass Inst of Tech. Nuclear forces released by atomic fission are electrostatic in nature. By means of generators operating in a complete vacuum as insulation instead of gas at high pressure, it may be possible to utilize nuclear energy directly without first converting it into heat as in the steam plants now harnessing the energy from chain reaction piles.

New Electronic Devices and Methods

Electronics is being applied industrially from automotive engine testing to fabrication of desk tops. In a two-part paper, an electronic dynamometer control was described by H. W. Gayek and the application of such dynamometers to automotive testing was explained by E. F. Kubler, both of General Electric Co. The d-c cradle dynamometer can be used conveniently for engine test-

no matter how

we tell it



IT'S NEWS

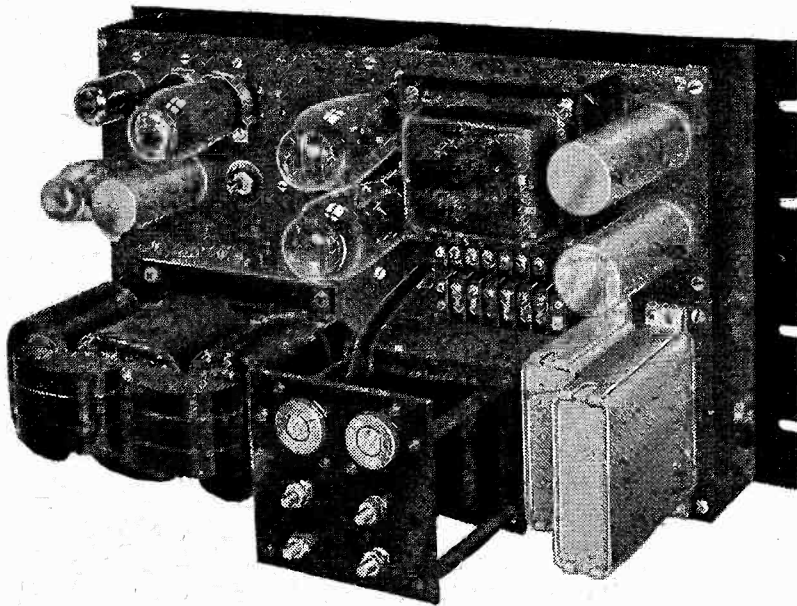

The **STABILINE** *Electronic* Voltage Regulator

Instantaneous in action with a maximum waveform distortion of 3 percent — this new completely-electronic voltage regulator maintains a stable output . . . within $\pm .1$ volt of nominal for line variations from 95 to 135 volts; within $\pm .15$ volt of nominal for any load current change or load power factor change from lagging .5 to leading .9.

Rated—Input: 95-135 volts, 1 phase, 60 cycles. Output: settable between 110-120 volts, 1 KVA. Let us supply you with complete technical and performance data.

WRITE-PHONE-WIRE -OR MAIL THIS COUPON TODAY

STABILINE *Electronic*
VOLTAGE
REGULATOR
THE Superior Electric
COMPANY
83 LAUREL STREET
BRISTOL, CONNECTICUT

The SUPERIOR ELECTRIC Company
BRISTOL, CONNECTICUT

LE

Gentlemen:

Please forward complete engineering and performance data on the new STABILINE electronic voltage regulator.

Company.....

Address.....

City.....State.....

Name.....Position.....

ing because it serves both to start and to drive the motor and to absorb power from it, in which case the dynamometer can return power to the mains by driving a d-c generator that in turn drives an induction generator. Conditions to be met for such operation are that field excitation to both dynamometer and motor be properly adjusted so that the dynamometer absorbs the required power from the motor under test at the test is driven at constant speed.

The fields can be controlled electronically. A tachometer is used as one element of a bridge circuit. Output from the bridge is then indicative of the direction and speed of shaft rotation. This output is used to control a rectifier circuit that in turn controls field excitation of the dynamometer through saturable core reactors whose a-c windings are parts of a phase shifting network. Another similar circuit controls the generator motor to keep the generator output at line frequency. Variable arms in the two bridge circuits, which can be ganged for some types of tests, are

Andrew Co. begins its second decade of service to the industry



- Transmission lines for AM-FM-TV
- Directional antenna equipment
- Antenna tuning units
- Tower lighting equipment
- Consulting engineering service

ANDREW

WRITE FOR
COMPLETE CATALOG

ANDREW CO.

363 EAST 75th STREET • CHICAGO 19

*Pioneer Specialists
in the Manufacture
of a Complete Line of
Antenna Equipment*

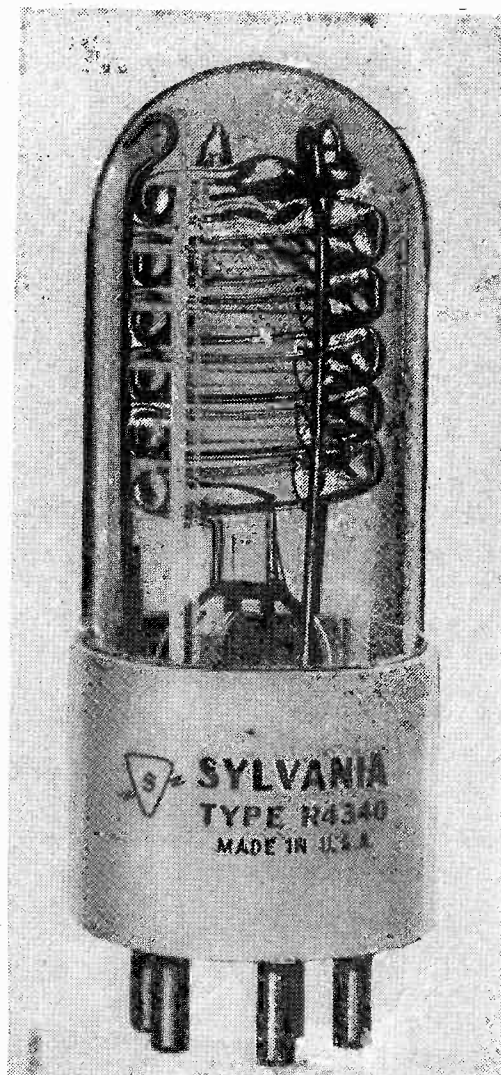
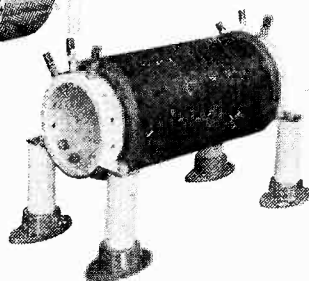
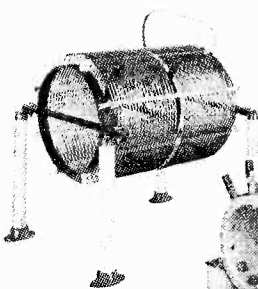
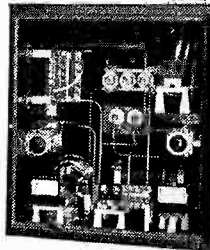
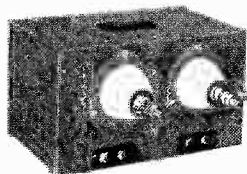
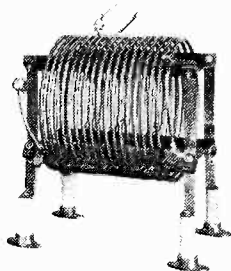
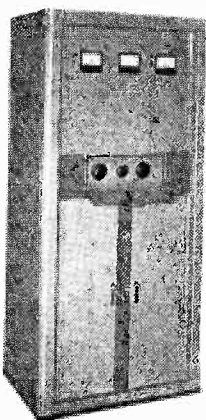
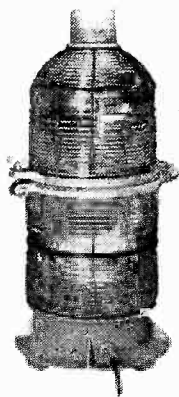
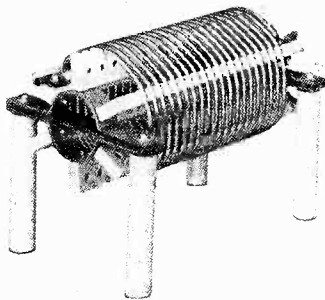
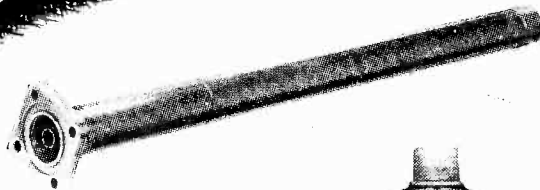
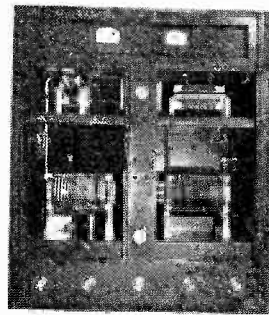

Tube has flash duration intermediate between strobatron and photoflash

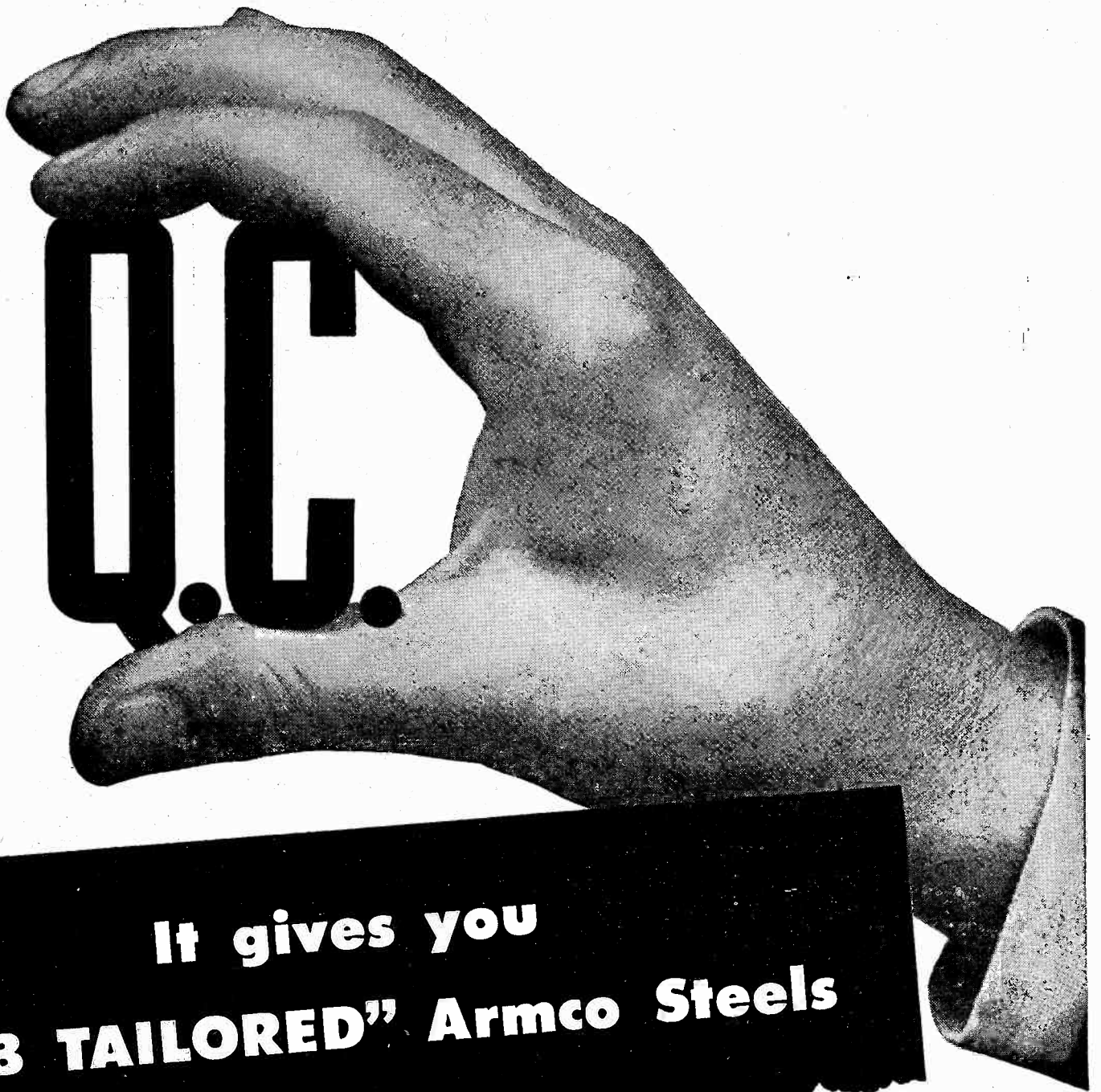

It gives you "JOB TAILORED" Armco Steels

When mill-ordered ARMCO Electrical Steels are unloaded in your plant you can be sure of this:

The steel is "job-tailored" to your needs—*before* and *during* rolling operations. Metallurgists and mill representatives see that you get the *one right steel* for your products.

For almost 20 years Armco men have called this "Q. C."—Quality Control. Metallurgists who study your requirements specify the analysis of steel, the temper rolling, annealing, and all other operations that affect the qualities of finished sheets and strip. Then mill operators follow through closely with these instruc-

tions on your individual routing card.

In recent years, Armco control charts and statistical analyses have further helped assure consistent production of prime electrical steels. They are an added safeguard for the steels that go into your products.

"Quality Controls" like these are one reason why leading manufacturers look first to Armco for special-purpose sheet steels.

Back of it all are the research and experience that contribute to a higher "Q. C." at our end and better quality at yours. The American Rolling Mill Company, 4231 Curtis St., Middletown, Ohio.

Export: Armco International Corporation

more scrap means more steel

We urge you to collect every pound of iron and steel scrap, including unused and obsolete equipment. Speed it to the steel industry through your regular channels. Present high production cannot be maintained unless more scrap is shipped to the mills promptly. The situation is critical; so act today.

The American Rolling Mill Company

Special-Purpose Sheet Steels • Stainless Steel Sheets, Bars and Wire



A CUP OF SAWDUST
AND CHICORY,
PLEASE!

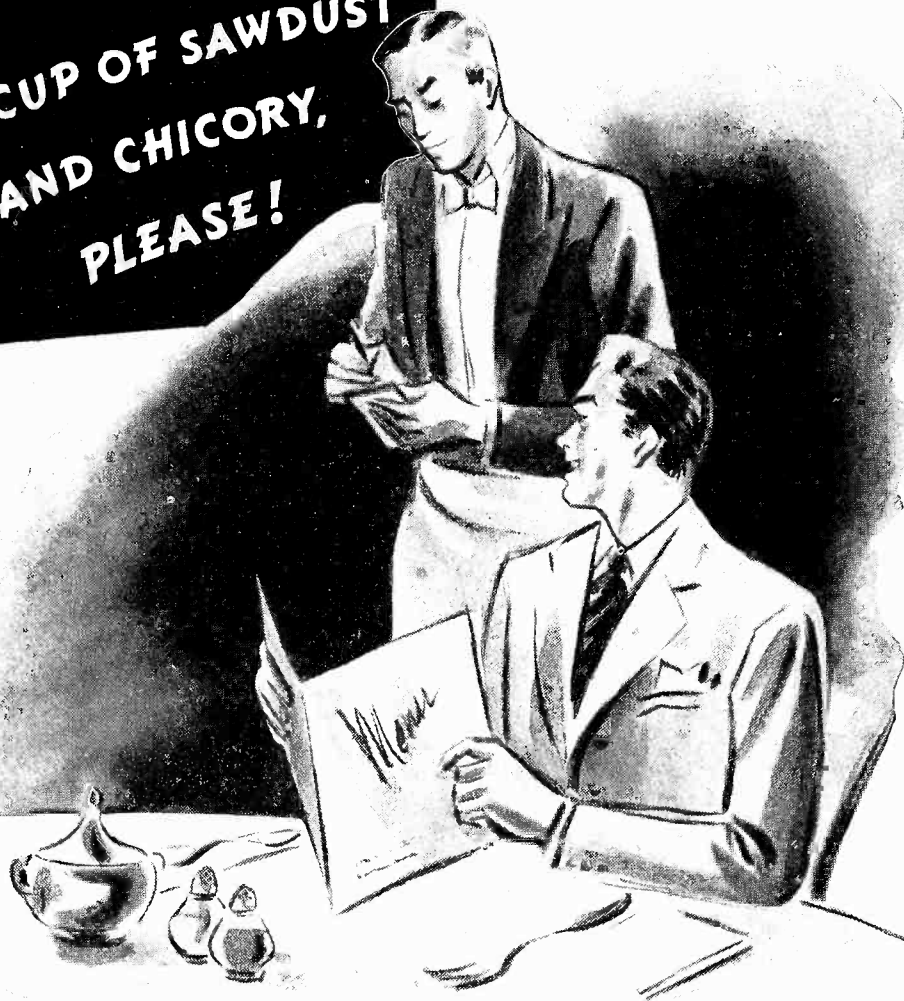

When they couldn't get the real thing, folks turned to ersatz coffee. But they didn't like it, because any substitute is always a makeshift for something else far better and more satisfactory. Substitutes for mica are no exception. Nothing can take the place of mica wherever insulation is important. And no other mica can equal Macallen in years of experience, world-wide resources and unfailing service.

You Need the **EXTRA MARGIN** of **SAFETY**
You Get with Macallen Mica



MACALLEN Mica

THE MACALLEN COMPANY, BOSTON 27, MASS.
CHICAGO: 565 W. Washington Blvd. CLEVELAND: 1231 Superior Ave.

ELECTRON ART

(continued)

charge tubes can be fired by a trigger tube actuated by a camera shutter synchronizer, and the others by phototubes observing the flash of the primary tube and operating trigger tubes associated with the other discharge tubes. These secondary discharge tubes flash within two microseconds of the primary tube.

The beam traveling-wave tube, used as a wideband amplifier for microwaves (ELECTRONICS, p 90 Nov 1946) was described by J. R. Pierce of Bell Tel Labs.

Edge gluing of boards to form panels and cores for furniture was described by J. M. Cragg of Raytheon Mfg Co. Dielectric heating is readily applicable as glue and board form parallel field paths instead of series (laminated) paths as in forming plywood. With glue and board parallel, the higher dielectric loss of the glue causes it to absorb most of the h-f power. Whereas using dielectric heating in plywood fabrication is expensive because heat is delivered to the wood as well as to the glue, it is both inexpensive and fast in fabricating edge-glued panels.

With 5 kw, and 250 lb per sq in. edgewise pressure holding the boards, the glue has set sufficiently for the panel to be run through the planer after 30 sec of dielectric heating. Minimum heating time is limited by flash point of the wood; size of panel that can be handled is limited by appearance of standing waves on the applicator plates (heating electrodes). Only control beside power pushbuttons for turning the equipment on and for applying r-f power to the applicator plates, is a wheel control for a variable inductor in series with the load to match it at different moisture contents or for different sizes or thicknesses of boards. In the production setup, glue is automatically applied to one edge of each board, the boards manually loaded between applicator plates, and pressure applied through pneumatic cylinders when the r-f is turned on.

High-frequency welding, especially as applied to vacuum tube assembly, was described at considerable length by William Parker of the Victor Division of RCA. By means of h-f (250—400 kc) local induction heating, one can produce

VARIACS . . .

for

CUTTING PIPE

ELECTRICALLY

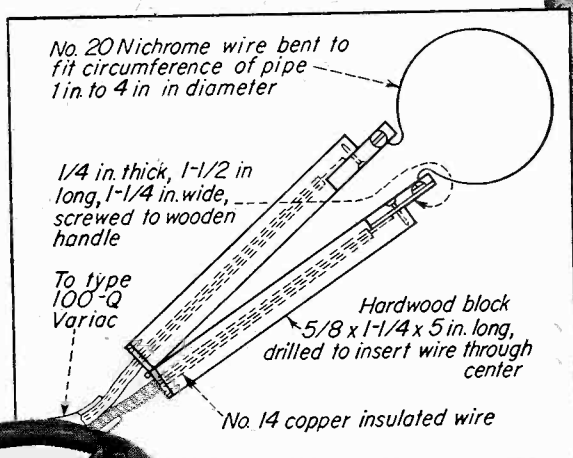
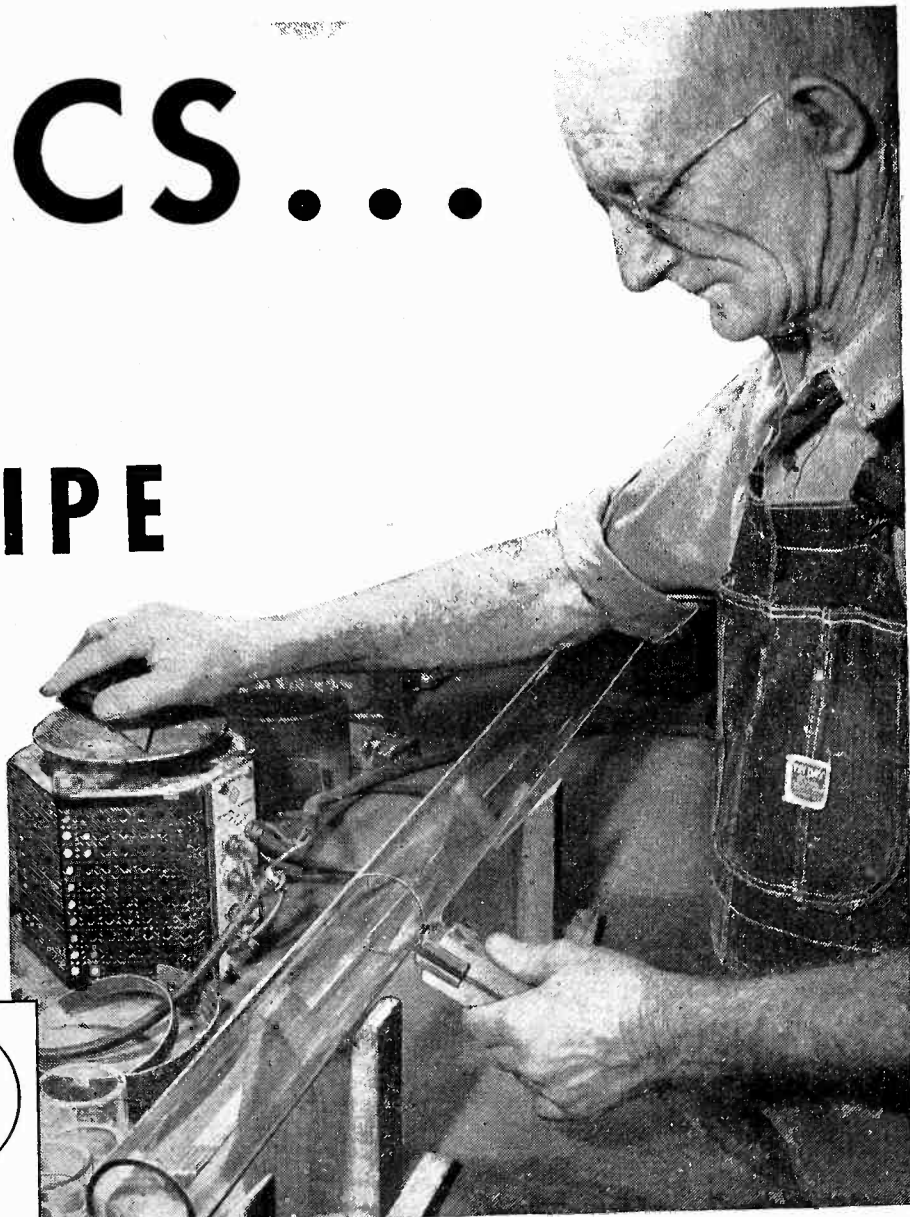

*T. M. Reg. U. S. Pat. Off.

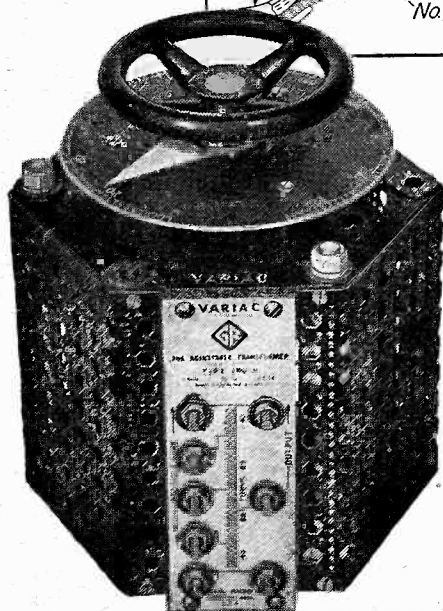

THE PROBLEM — To make 35,000 cuts in over 7½ miles of Pyrex glass pipe, in diameters up to four inches . . . to make them quickly and cleanly.

THE ANSWER — Stone & Webster Engineering Corporation, at the Clinton Engineering Works in Oak Ridge, Tenn., in connection with the Manhattan Project, had the job to do. The answer is as simple as this:

An adjustable loop of No. 20 Nichrome wire to fit around the pipe in the gadget illustrated above, a Type 100-Q VARIAC* and a foot switch to turn the current on and off. The tubing was scored with a file, the loop was adjusted to fit the pipe at the score marks and, at predetermined settings of the VARIAC depending upon the diameter of tubing, current was applied to the loop through the VARIAC for an average of 40 seconds. A damp cloth rubbed around the heated pipe resulted in a clean break.

Simple? Almost all heat, speed, light and voltage control problems are simple . . . some ingenuity . . . and a VARIAC!

VARIACS are manufactured in power ratings from 170 va to 17 kva and are basically priced from \$11.50 to \$388.00.

● WRITE FOR A COPY OF THE VARIAC BULLETIN

VARIACS

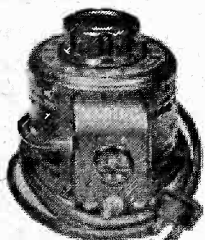

Made ONLY by

Main Office, Laboratories and Factory:
275 MASSACHUSETTS AVENUE, CAMBRIDGE 39, MASS.
 Branch Engineering Offices: 90 West Street, New York 6 • 920 So. Michigan Avenue, Chicago 5
 950 No. Highland Avenue, Los Angeles 38
 SINCE 1915 Manufacturers of Precision Electrical Laboratory Apparatus

GENERAL RADIO

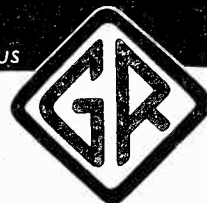

welds. The technique is advantageous because there is no wear on electrodes, no work contamination, the process is readily controlled, there is little mechanical deformation of the work, and because of the energy concentration and short heating time, little power is required. A complete weld can be formed simultaneously by proper shaping of the applicator coils.

About 8-100 kw r-f output power is fed to the applicator coils through a step-down impedance matching transformer in which the secondary is the slotted case. Filament voltage to the power oscillator tubes is below normal during standby, but is raised to somewhat above normal during the short interval of welding, thus high power is obtained from a given unit but tube life is not impaired.

As the metal melts, its resistance doubles thus doubling the heat developed internally. Also, the loading on the oscillator is increased. If overcoupling is used, the increased loading decreases the available output power thus preventing the weld from being heated so much that it flows. By using a preheating, welding, postheating cycle, better welds are obtained. Welding can be controlled so precisely that unsuspected metallurgical variations in metals become apparent. In welding copper, the applicator coil is made of copper and water cooled, otherwise it would melt before the work. Using this technique to form simultaneous ring welds, tube subassemblies can be formed automatically using phototubes to time the welding cycle and machine indexing.

Other papers presented at the meeting were made available by preprints through the society at the time of the convention and can be obtained in entirety through the AIEE.

SIX FAMILIES in a mountain valley near Cle Elum, Wash. will have telephone service for the first time this winter, even though the homes are beyond reach of existing telephone lines. Carrier telephone service is to be provided, with Pacific Telephone & Telegraph Co. making the installation on the lines of Kittitas County P.U.D. No. 1.



● The Sorensen NOBATRON provides a new source of DC voltages regulated at currents previously available only with batteries.

● Six standard NOBATRON models operate on a 95-125 volt AC source of 50 to 60 cycles and provide currents of 5, 10, and 15 amperes at output voltages of 6, 12, or 28.

● Ideally suited for critical applications where constant DC voltages and high currents are required, the NOBATRON maintains a regulation accuracy of $\frac{1}{2}$ of 1%, RMS of 1% and has a recovery time of $\frac{1}{5}$ of a second.

● Investigate the many advantages of Sorensen regulators applied to your unit. Write today for your copy of the new complete Sorensen catalog, S-L. It is filled with schematic drawings, performance curves, photos, and contains in detail, "Principles of Operations."



SORENSEN & COMPANY, INC.
STAMFORD, CONNECTICUT

A LINE OF STANDARD REGULATORS FOR LOAD RANGES UP TO 30 KVA.
SPECIAL UNITS DESIGNED TO FIT YOUR UNUSUAL APPLICATIONS.

Finer Plastics...

hot off the griddle!

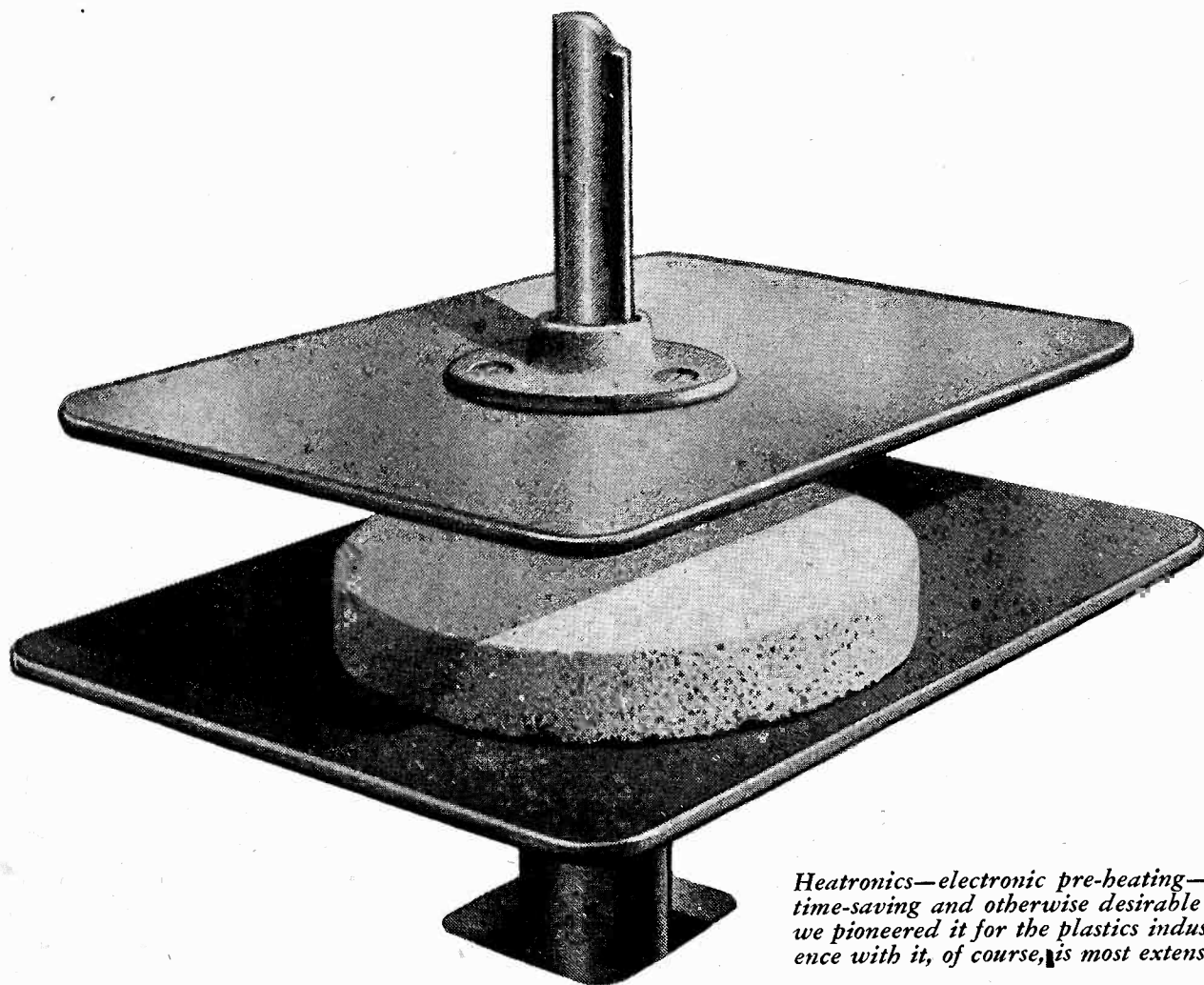

Heatronics—electronic pre-heating—has become outstanding as a time-saving and otherwise desirable technique in many ways since we pioneered it for the plastics industry back in 1943. K-K experience with it, of course, is most extensive.

WHAT HAPPENS when a custom molder of plastics gets a bright idea? One that cuts production time, improves quality or develops into new applications?

Well—if you're his customer, *you* get the benefit first. If not, maybe your competition gets it.

Kurz-Kasch customers have found their competitive positions thus improved many, many times in relationships frequently going back 30 years. We think these past achievements speak well for more to come. So why not let us tell you our story—now? Your copy of "A Businessman's Guide to the Molding of Plastics" is yours—free—for the asking.



Kurz-Kasch

*For Over 30 Years
Planners and Molders in Plastics*

Kurz-Kasch, Inc., 1425 S. Broadway, Dayton 1, Ohio. *Export Offices:* 89 Broad Street, New York, N. Y.
Branch Sales Offices: New York • Chicago • Detroit • Los Angeles • Dallas • St. Louis • Toronto, Canada.

for **ACCURACY**
with **ECONOMY**

specify **AMPREDIZED**

Dials • Scales • Screens

These typical attributes of dials, scales, and screens are obtained by the automatic graduating process designated "ampredizing."

Precision to 2 minutes in 360 degrees on radial scales with even the closest graduations — equivalent accuracy on straight linear scales up to 15 feet long.

Versatility in combining radial scales as a single dial: anti-parallax scales accurately matched on both faces of material up to 1/2 inch thick.

Economy of automatic production provides "ampredized" scales at cost generally below that of conventional pantograph engraving.

Quotations on scales "ampredized" to your specifications will be furnished promptly.

American **PRECISION DIAL Co.**
93 MASSACHUSETTS AVENUE BOSTON 16, MASS.

NEW PRODUCTS (continued from p 160)

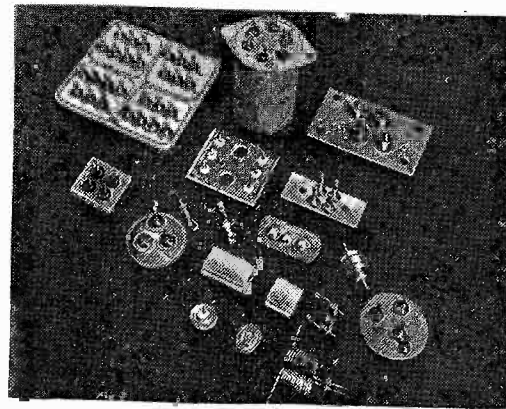

they are vacuum tight; have resistance of over 10,000 megohms between body and terminals or between terminals; have a permanent chemical bond between metal and glass; are capable of withstanding shock of hot tin dipping to facilitate soldering. Terminals in the headers may be arranged with a minimum of spacing in any pattern or combination of voltage ratings. An unlimited variety of shapes in multiple headers with as many terminals as desired molded into a cover unit can be made at a substantial saving in material costs.

Photoelectric Counter (17)

PHOTOSWITCH, INC., 77 Broadway, Cambridge 42, Mass. The photoelectric counter type P1 provides a completely packaged, easily installed, general-purpose photoelectric counter at low cost. It consists of a photoelectric control, light source, and electric counter. The only equipment which needs to be located at the point of count is the control and the light source. One or more electric counters (containing the counter face and reset knob)

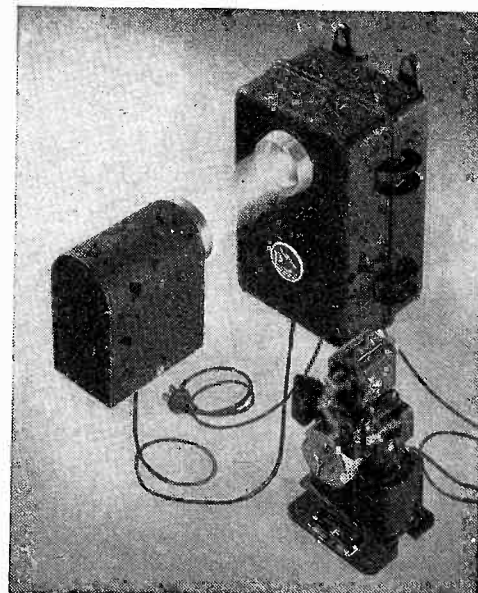

INVISIBLE BUT INVALUABLE

The invisible part of any Blaw-Knox Radio Tower is the *accumulated experience* gained by this company in the installation of thousands of towers in many quarters of the globe. This experience counsels the use of better material instead of cheaper material, higher safety factors instead of lower, the best construction instead of "good enough" and, in a word, the best.

The Blaw-Knox Tower you buy contains this priceless element without extra cost to you. Let us discuss your requirements without obligation.

BLAW-KNOX DIVISION
OF BLAW-KNOX COMPANY
2077 Farmers Bank Building, Pittsburgh 22, Pa.

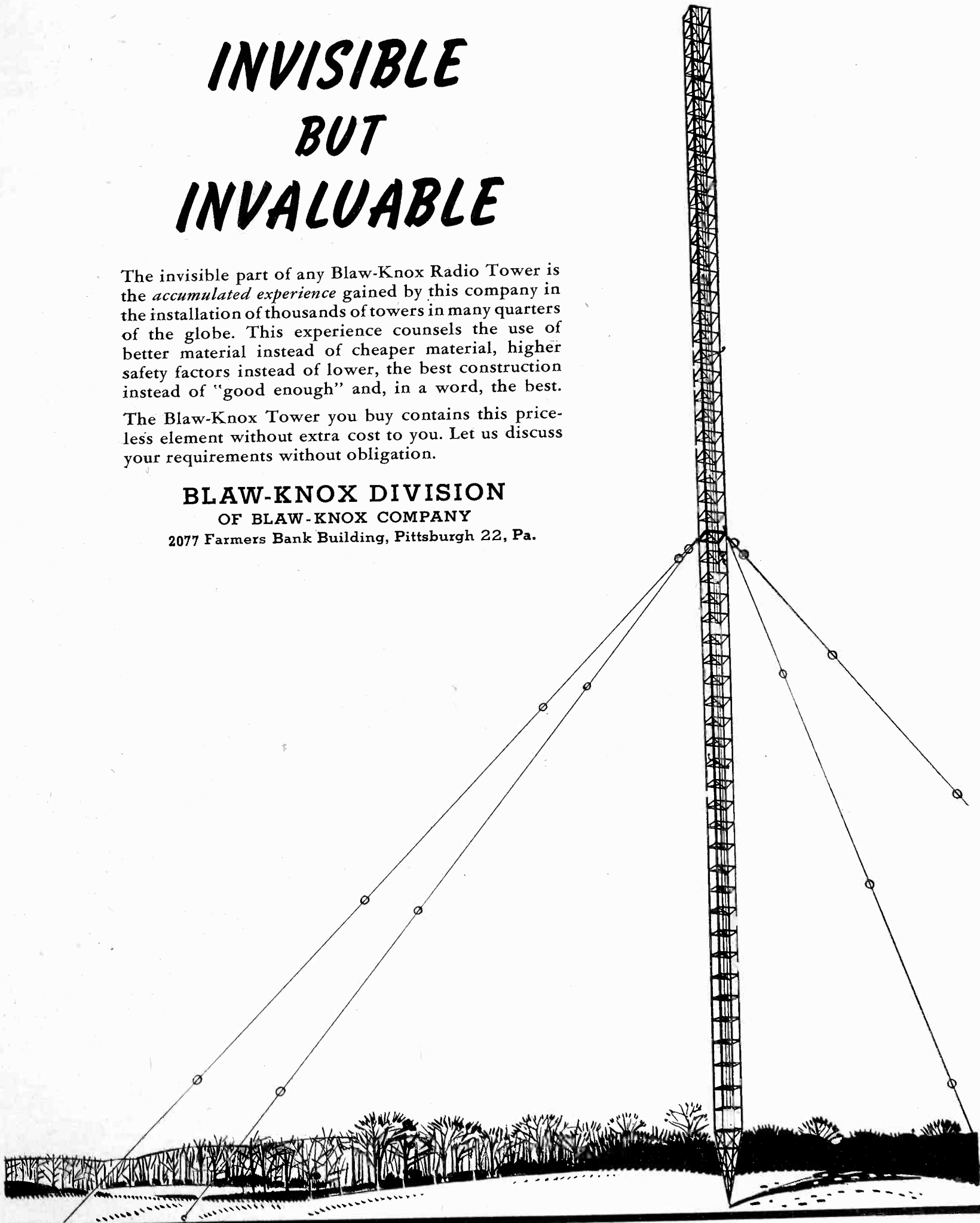

BLAW-KNOX ANTENNA TOWERS

S.S. WHITE FLEXIBLE SHAFTS

satisfy every need for

**SMOOTH,
SENSITIVE REMOTE CONTROL**

OVER SHORT DISTANCES

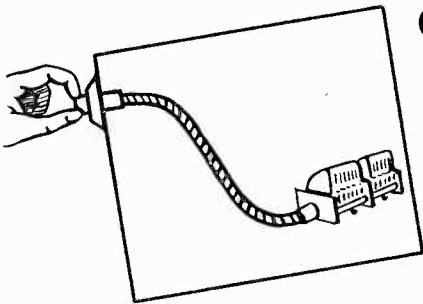

... OVER LONG DISTANCES

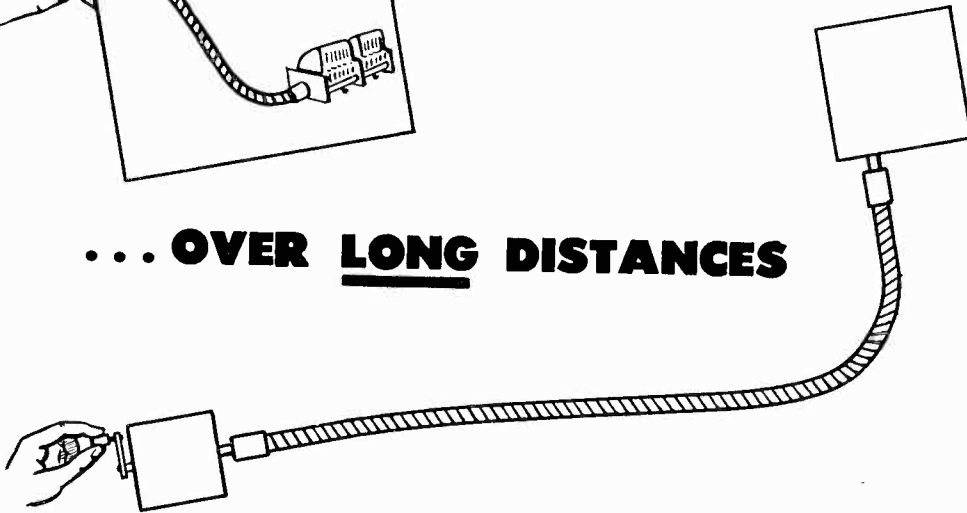

S.S. White remote control type flexible shafts are specially engineered and built for remote control applications. Their torsional deflection under load is very small and is the same for either direction of rotation.

With these S.S. White remote control flexible shafts you can get smooth, easy operation with any required degree of sensitivity over long distances as well as short. For the full story,

WRITE FOR 260-PAGE HANDBOOK—FREE

It gives complete facts and technical data about flexible shafts and their application. A copy will be sent free if you write for it direct to us on your business letterhead and mention your position.



S.S. WHITE INDUSTRIAL DIVISION
THE S. S. WHITE DENTAL MFG. CO. DEPT. E, 10 EAST 40th ST., NEW YORK 16, N. Y.



FLEXIBLE SHAFTS • FLEXIBLE SHAFT TOOLS • AIRCRAFT ACCESSORIES
SMALL CUTTING AND GRINDING TOOLS • SPECIAL FORMULA RUBBERS
MOLDED RESISTORS • PLASTIC SPECIALTIES • CONTRACT PLASTICS MOLDING

One of America's AAAA Industrial Enterprises

may be placed at any convenient location and wired to the control. Speed of operation is up to 600 counts per minute. Operating range allows 6 feet between photoelectric unit and light source. The device counts to 99,999 before returning to zero. Further details are given in Bulletin 20A1.

Sweep Oscillator (18)

KAY ELECTRIC Co., East Orange, N. J. The Mega-Sweep Jr. provides a frequency sweep up to 30 mc over the spectrum from 400 kc to 500 mc. Output frequency can be increased to 1,000 mc. The output frequency

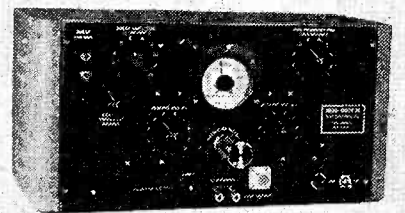

is measured by means of a precision wavemeter calibrated up to 900 mc and it covers the entire range without switching. The unit has its own power supply encased with the sweep circuit, the total weight being 20 pounds. It sells for \$195.

Tone Arm (19)

ROBINSON RECORDING LABORATORIES, 9th and Chestnut Sts., Philadelphia, Pa. A new transcription tone arm for broadcast use is made of cast aluminum and is nonresonant. It is 17½ inches long and is counterbalanced with a lead weight so as to effect less than an ounce pressure on the sapphire point used. A General Electric variable reluctance magnetic cartridge is employed and the unit is arranged to couple directly into a 250-ohm fader input. A two-stage equalizing preamplifier

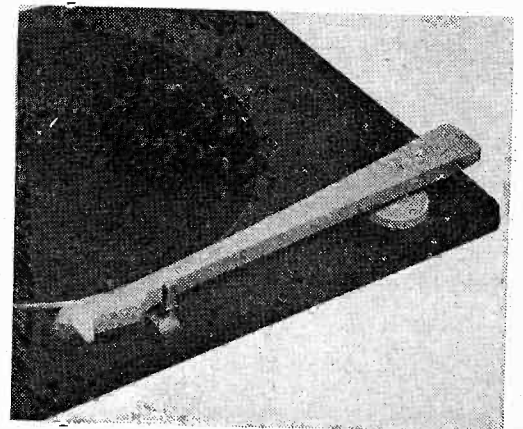

IT DOES THE JOB OF SOLID SILVER

Yet It's Yours at Low Cost...

GENERAL PLATE LAMINATED SILVER METALS

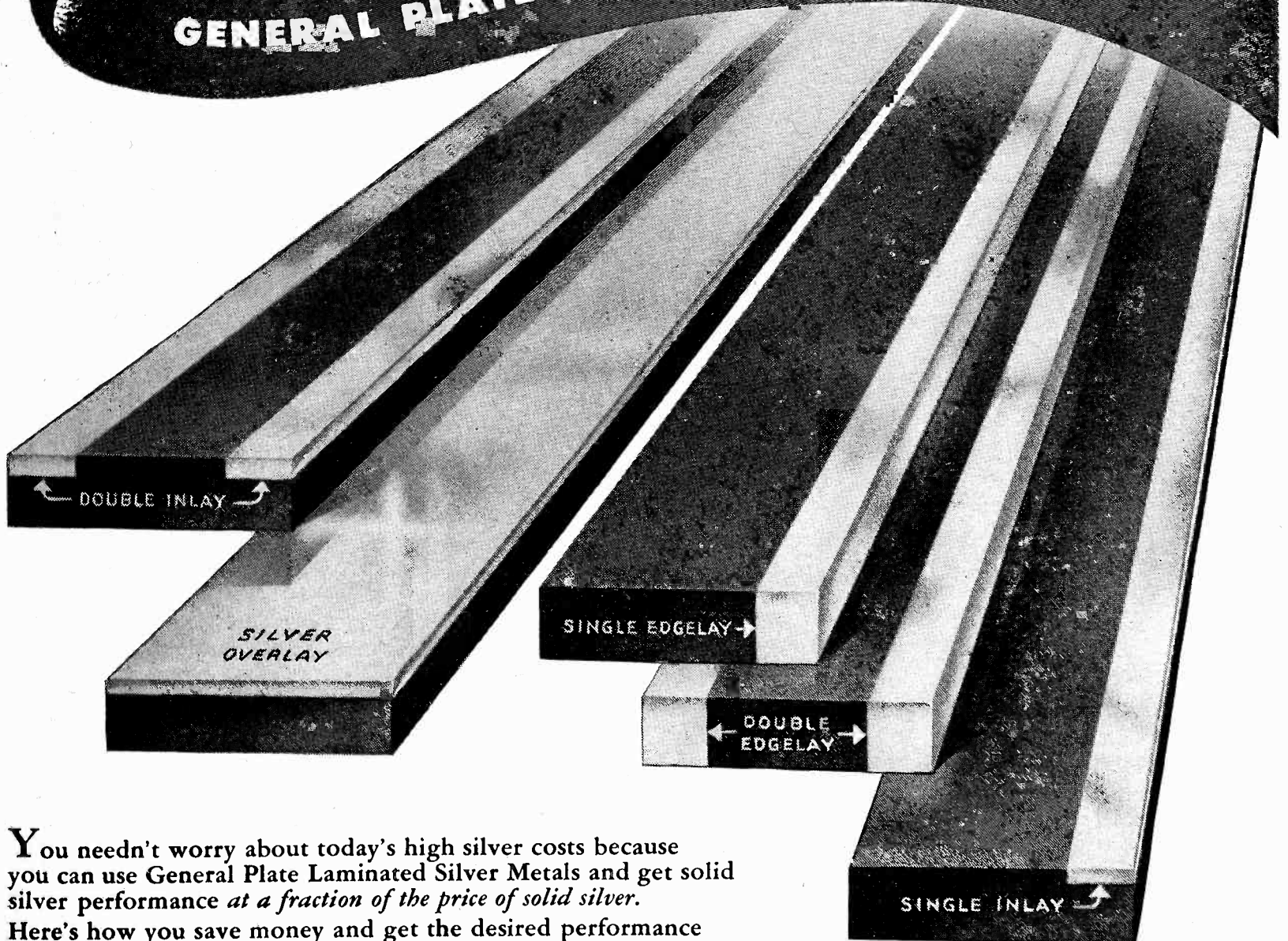

You needn't worry about today's high silver costs because you can use General Plate Laminated Silver Metals and get solid silver performance *at a fraction of the price of solid silver.*

Here's how you save money and get the desired performance characteristics, too. General Plate Laminated Metals are made by permanently bonding thin layers of silver or other precious metals to thicker inexpensive base metals. Thus you get the precious metal performance at a cost slightly higher than the cost of the base metal.

Among the advantages of General Plate Laminated Metals, you get better electrical conductivity, high corrosion resistance, workability, ease of fabrication, better spring properties, long wearing life and structural and mechanical properties not obtainable with single solid precious metals.

General Plate Laminated Metals are available in sheet, wire and tube form with precious metal on one side, or both sides in practically any combination.

Investigate the advantages of General Plate Laminated Metals, today.
Wire for information.

GENERAL PLATE DIVISION

of Metals and Controls Corporation

A T T L E B O R O , M A S S A C H U S E T T S

50 Church St., New York, N.Y.; 205 W. Wacker Drive, Chicago, Ill.; 2635 Page Drive, Altadena, California; Grant Bldg., Pittsburgh, Pa.

Unusual Opportunity

for **ELECTRONICS ENGINEERS**
PHYSICISTS
MATHEMATICIANS
AERONAUTICAL ENGINEERS!

If you feel that your present connection does not offer maximum opportunity for expansion, here's your chance to go places in aviation, a field with a future! The Glenn L. Martin Co. has available a number of excellent positions . . . paying \$300 to \$600, depending on experience . . . for men with advanced college training and development experience. Interesting research work on Guided Missiles, Pilotless Aircraft, Fire Control Systems and Electronics Equipment. Unusually complete engineering and laboratory equipment . . . millions of dollars in contracts for research and development in the electronics, missile and propulsion fields.

This is your opportunity to break away from monotonous routine and give full scope to your research ability. Associate now with America's foremost aircraft manufacturer, holding nearly one-fifth of all the aircraft orders in the nation . . . a company with a \$201,000,000 backlog of orders in such diverse fields as military aircraft, commercial aircraft, ground equipment, plastics, photography, gun turrets, etc. Write today, outlining your experience and find out what Martin can offer you. Interviews will be arranged in your own locality.

*Men are especially needed
to do original work in the following fields:*

1. R. F. Components, Wave Guides, etc.
2. Pulse Techniques, Precision Timing, Indicator Circuitry, I. F. Amplifiers, AFC, etc.
3. Microwave Antennae.
4. Servos and Computers.

Write immediately to:

PROFESSIONAL EMPLOYMENT SECTION
THE GLENN L. MARTIN COMPANY
BALTIMORE 3, MARYLAND

NEW PRODUCTS

(continued)

is also furnished. This unit is equipped with a five-position switch that allows reproduction of any type of recording. The tone arm alone sells for \$74.50 and the equalizer preamplifier without power supply is \$27.50.

Photoelectric Pilot (20)

MARINE DIVISION, KIRSTEN PIPE CO., 1165 Eastlake Ave., Seattle 9, Wash. The model 45 photoelectric pilot is a device for automatically steering vessels from 20 feet up to about 50 feet in length and is designed as an attachment for conventional

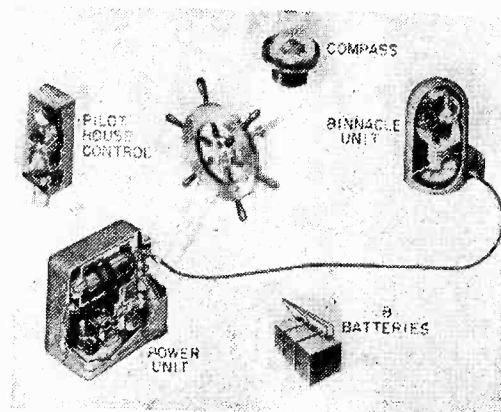

hand steering gear. The binnacle unit illustrated is the heart of the system that automatically directs the steering system by means of changes in the power unit. The course is set at the pilot house control which may also have a remote control course changing switch. Power is obtained from a block of B batteries and the ship's battery.

Voltage Regulator Unit (21)

VICTOREEN INSTRUMENT CO., 5806 Hough Ave., Cleveland 3, Ohio. The model 348 voltage regulator unit contains seven subminiature gaseous voltage regulator tubes arranged circumferentially and housed in an aluminum casting with octal base. The unit offers close regulation and maintains stability over long periods of time. Its compact arrangement makes it unique for many circuit development ap-

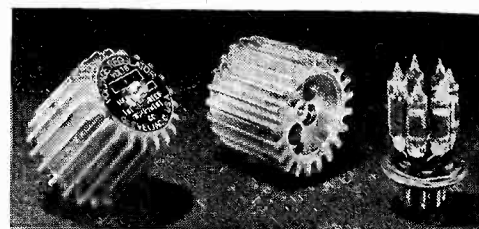

PLASTICON* ASG Silicone-Filled GLASSMIKES

1-3/8 x 3-1/2



FOR HIGHER VOLTAGES

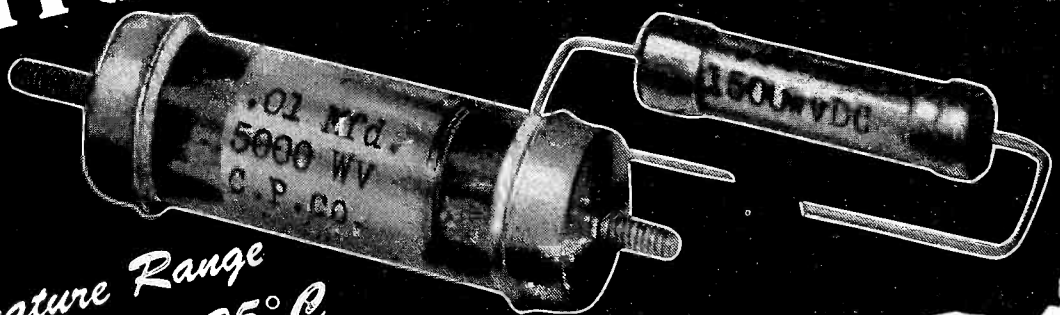

*Extreme Temperature Range
from Minus 60° C to Plus 125° C*

From 600 to over 30,000 Volts

Modern functionally designed capacitors. Metal ferrules are soldered to silver bands used to each end of heavy-walled glass tubes. This vacuum tight assembly is fungus-proof and passes Signal Corps, Air Corps and Navy thermal cycle and immersion tests.

Announcing an illustrated technical booklet on uses of

PLASTICON* GLASSMIKES

Contains the following subjects:—

- Glassmike characteristics and design data
- Comparison of Glassmike and Mica Capacitors
- Uses of Glassmikes for improved RF and Audio bypassing
- Use in Audio and RF coupling
- Glassmike in television power supplies
- Video coupling
- Vibrator buffer applications
- Geiger Counter Capacitors
- Instrument Capacitors
- And many other applications

* PLASTICONS: Plastic-Film Dielectric Capacitors

WRITE for above free booklet
on your firm letterhead.

Order from your jobber: if he cannot supply you, order direct



Condenser Products Company

1375 NORTH BRANCH STREET • CHICAGO 22, ILLINOIS

Designed for

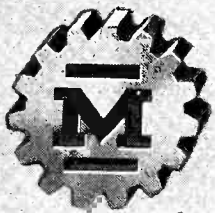

Application



92101

The No. 92101—Antenna Matching Pre-amplifier

The Millen 92101 is an electronic impedance matching device and a broad-band pre-amplifier combined into a single unit, designed primarily for operation on 6 and 10 meters. Coils for 20 meter band also available. This unit is the result of combined engineering efforts on the part of General Electric Company and the James Millen Manufacturing Company. The original model was described in G.E. Ham News, November-December, 1946. The No. 92101 is extremely compact, the case measuring only 6 1/4" x 5 3/4" x 3". The band changing inductor unit plugs into the opening in the front of the panel. Plug is provided for securing power requirements for the 6AK5 tube from the receiver. Coaxial connectors are furnished for the antenna and receiver connections.

**JAMES MILLEN
MFG. CO., INC.**

MAIN OFFICE AND FACTORY
**MALDEN
MASSACHUSETTS**



NEW PRODUCTS

(continued)

applications where space is at a premium. Individual voltage regulator tubes may be secured separately with operating voltage of 129 to 134 volts at 1.75 ma. Regulation is maintained within 0.5 volt.

Industrial Paging Speaker (22)

UNIVERSITY LOUDSPEAKERS, INC.,
225 Varick St., New York 14, N. Y.
The model MIL industrial paging speaker is absolutely immune to moisture, salt spray, and vibration

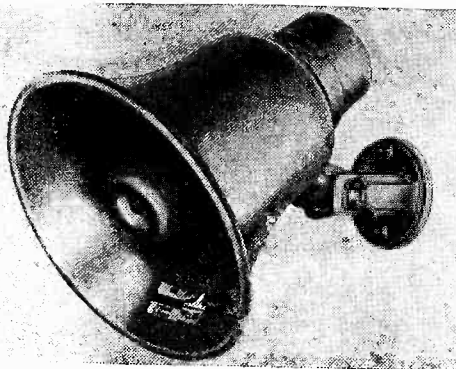

Dispersion angle is 120 degrees; power output, 5 watts; impedance, 8 or 45 ohms. The diameter is 6 inches, height is 7 inches, and the unit weighs 3 1/2 pounds.

UHF Double Triodes (23)

SYLVANIA ELECTRIC PRODUCTS INC.,
500 Fifth Avenue, New York 18,
N. Y. Two new double triodes providing single-ended operation for cascade amplifiers operating at frequencies up to 400 mc are available. The high mutual conductance tubes have independent elements with the exception of heaters, permitting an

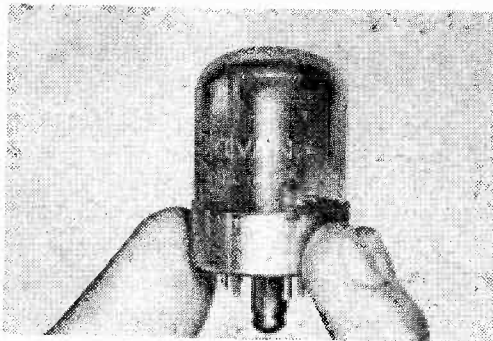

appreciable saving in space and number of tubes required. Circuit applications include grounded-grid, cathode followers and push-pull amplifiers and converters in the new f-m and television bands where low equivalent noise resistance obtained with triode converters is desirable. Type 7F8 is supplied with a 6.3 volt, 0.300 ampere heater. Similar ratings for type 14F8 are 12.6 volts

**Tracing cloth
that defies
time**

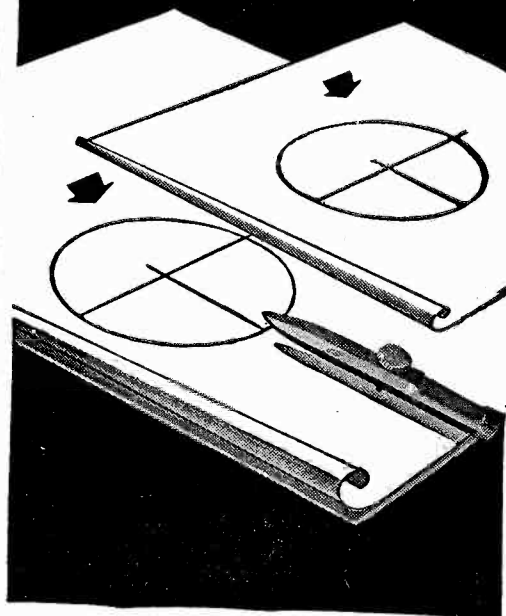

● The renown of Imperial as the finest in Tracing Cloth goes back well over half a century. Draftsmen all over the world prefer it for the uniformity of its high transparency and ink-taking surface and the superb quality of its cloth foundation.

Imperial takes erasures readily, without damage. It gives sharp contrasting prints of even the finest lines. Drawings made on Imperial over fifty years ago are still as good as ever, neither brittle nor opaque.

If you like a duller surface, for clear, hard pencil lines, try Imperial Pencil Tracing Cloth. It is good for ink as well.

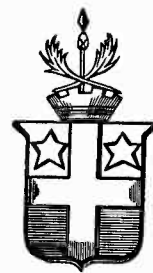

**IMPERIAL
TRACING
CLOTH**



SOLD BY LEADING STATIONERY AND DRAWING MATERIAL DEALERS EVERYWHERE

electronics READER SERVICE . . .

LITERATURE and NEW PRODUCTS

Manufacturers' Literature as well as further information on New Products described in this issue are important "working tools" for design and production departments. To make it easy to keep up to date, ELECTRONICS will request manufacturers to send readers the literature in which they are interested. Just fill out card as shown in the filled-in sample (right), being particularly careful to write out in full all the information called for in each section of each card that is used.

Write in circle number of item describing one item wanted → (14) Your Company Name <i>Jones Mfg Co.</i> Address <i>3217 Lewis Ave.</i> <i>Chicago 13, Ill.</i> Your Name <i>Geo. Smith</i> Your Title <i>Chief Engineer</i> ELECTRONICS, 330 W. 42nd St., N. Y. 18	Write in circle number of item describing one item wanted → (12) Your Company Name <i>Jones Mfg Co.</i> Address <i>3217 Lewis Ave.</i> <i>Chicago 13, Ill.</i> Your Name <i>Geo. Smith</i> Your Title <i>Chief Engineer</i> ELECTRONICS, 330 W. 42nd St., N. Y. 18
Write in circle number of item describing one item wanted → (37) Your Company Name <i>Jones Mfg Co.</i> Address <i>3217 Lewis Ave.</i> <i>Chicago 13, Ill.</i> Your Name <i>Geo. Smith</i> Your Title <i>Chief Engineer</i> ELECTRONICS, 330 W. 42nd St., N. Y. 18	Write in circle number of item describing one item wanted → (49) Your Company Name <i>Jones Mfg Co.</i> Address <i>3217 Lewis Ave.</i> <i>Chicago 13, Ill.</i> Your Name <i>H. S. Towne</i> Your Title <i>Adv. Mgr.</i> ELECTRONICS, 330 W. 42nd St., N. Y. 18

**SAMPLE
CARD
SHOWING
CORRECT
FILL-IN**
←

PLACE 1¢ STAMP ON CARD • DO NOT USE AFTER JULY 1

HOW TO ORDER:

- There are two postcards, each divided into four parts. Each of the four parts contains a box. You must write in this box the number that appears in this issue over the literature or new product item in which you are interested. Place one number only in each box.
- Fill out completely (name, address, etc.) for each piece of literature or new product information you desire.
Do not say "same" in lieu of writing out full information called for when requesting more than one item.
- This service applies only to literature and new product items in this issue. It does not apply to advertisements. Write directly to the company for information on its advertisements.

PLEASE NOTE: Requests for un-numbered items must be made direct to the manufacturer.

In the event this copy of ELECTRONICS is passed along to other members of your company, please leave this sheet in for their convenience. This assures everyone in your plant the opportunity to fill in their requests. When the round is completed, cards can then be detached along perforated lines and dropped in the mail. Each individual request will be mailed by us to the company offering the information and for that reason must be completely filled out.

Write in circle number of item describing one item wanted →

Your Company Name.....
 Address.....
 Your Name.....
 Your Title.....
 ELECTRONICS, 330 W. 42nd St., New York 18, N. Y.

Write in circle number of item describing one item wanted →

Your Company Name.....
 Address.....
 Your Name.....
 Your Title.....
 ELECTRONICS, 330 W. 42nd St., New York 18, N. Y.

Write in circle number of item describing one item wanted →

Your Company Name.....
 Address.....
 Your Name.....
 Your Title.....
 ELECTRONICS, 330 W. 42nd St., New York 18, N. Y.

Write in circle number of item describing one item wanted →

Your Company Name.....
 Address.....
 Your Name.....
 Your Title.....
 ELECTRONICS, 330 W. 42nd St., New York 18, N. Y.

Write in circle number of item describing one item wanted →

Your Company Name.....
 Address.....
 Your Name.....
 Your Title.....
 ELECTRONICS, 330 W. 42nd St., New York 18, N. Y.

Write in circle number of item describing one item wanted →

Your Company Name.....
 Address.....
 Your Name.....
 Your Title.....
 ELECTRONICS, 330 W. 42nd St., New York 18, N. Y.

Write in circle number of item describing one item wanted →

Your Company Name.....
 Address.....
 Your Name.....
 Your Title.....
 ELECTRONICS, 330 W. 42nd St., New York 18, N. Y.

Write in circle number of item describing one item wanted →

Your Company Name.....
 Address.....
 Your Name.....
 Your Title.....
 ELECTRONICS, 330 W. 42nd St., New York 18, N. Y.

An electronics service designed for **READERS and MANUFACTURERS**

FOR THE READER . . . ELECTRONICS fundamental policy has always been to supply its readers with all the pertinent and timely industry news. The ELECTRONICS Reader Service supplements this policy by offering the reader an easy and effective means of obtaining complete, up to the minute data on new products and of maintaining at his fingertips comprehensive, practicable information on "who's doing what" in the industry.

In every issue of ELECTRONICS there's complete coverage of the month by month development by manufacturers of new materials, components and equipment, as well as brief mention of all the important, new, manufacturers' technical pamphlets and catalogs. Some of these items will be of particular interest to specific design and plant engineers, buyers, executives and others of our readers. They will want to make further inquiry concerning the new products described or they will want to read and make a permanent part of their industrial library some of the manufacturers' literature and catalogs. ELECTRONICS

Reader Service makes it easy for them to obtain in readily accessible and usable form the information they desire.

PLACE 1¢ STAMP ON CARD • DO NOT USE AFTER JULY 1

Place
1¢
Stamp
Here

ELECTRONICS

330 WEST 42nd STREET

NEW YORK 18, N. Y.

4-1-47

FOR THE MANUFACTURER . . .

ELECTRONICS Reader Service will also be welcomed by manufacturers who are desirous of placing the complete news of their product developments as well as their technical bulletins and catalogs in the hands of those members of the electronic industry . . . including design, electrical and production engineers, researchers, physicists, executives, and buyers—who have a particular interest in, or represent a potential buying power for, their products.

SUGGESTIONS FOR THE IMPROVEMENT OF OUR READERS' SERVICE ARE INVITED

ELECTRONICS is constantly seeking new and improved ways of providing its readers with the news and information they want and need, and of assisting the manufacturer in effectively delivering his message to electronic markets. If you have any ideas for us, send them along. They will receive prompt consideration.

Place
1¢
Stamp
Here

ELECTRONICS

330 WEST 42nd STREET

NEW YORK 18, N. Y.

4-1-47

Good news for bad memories

WHAT housewife hasn't put a strain on her husband's good nature by occasionally forgetting to turn off electrical appliances? Industrial Devices, Inc., Edgewater, N. J., has an answer to that universal problem. It's Handi Glow — a simple pilot light attachment that jogs the memory with a visual reminder that the appliance is "on." Fits any standard 2-prong plug. Transfers easily from one plug to another. Also can be used as a voltage test light.

Like many other successful wiring devices, the Handi Glow is equipped with a G-E Neon Glow Lamp—"the glow that lets you know."

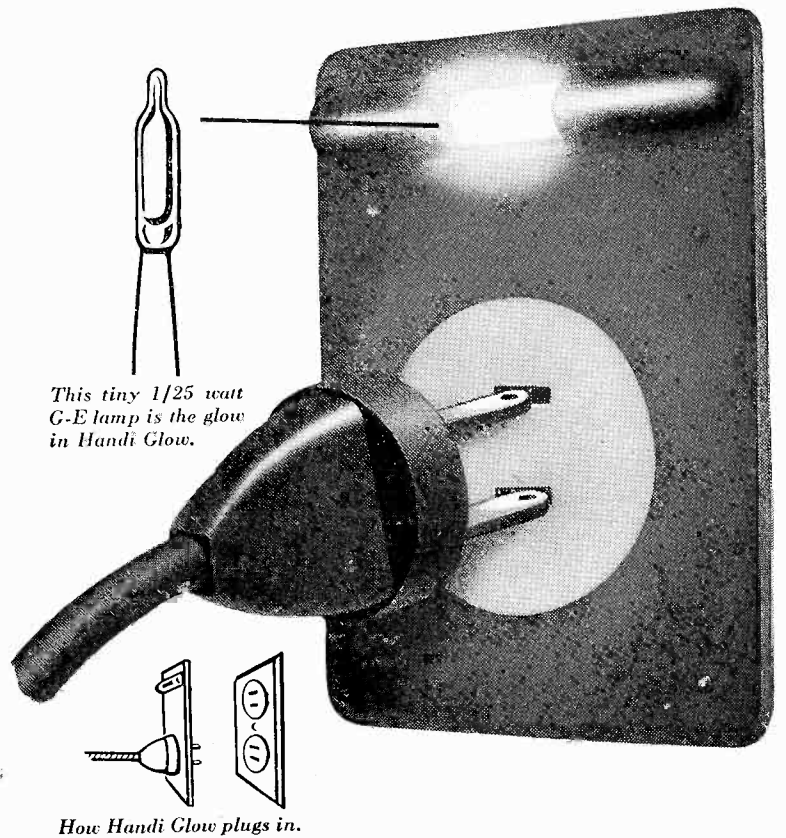

This tiny 1/25 watt G-E lamp is the glow in Handi Glow.

How Handi Glow plugs in.

...and it's profit news to you!

TYPICAL WIRING DEVICES USING G-E GLOW LAMPS

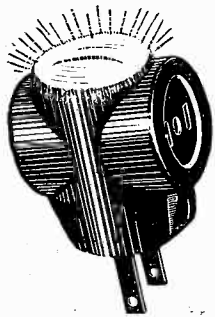

SAFETY PILOT PLUG combining nite-lite, 2-way plug and electric cord cap.



LIGHTED SWITCH PLATE ends fumbling. Light stays on when room is dark.

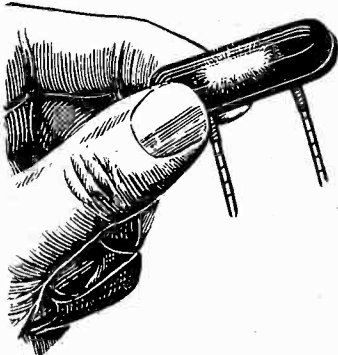

MIDGET PILOT LIGHT for permanent attachment to instrument panels and electrical apparatus.

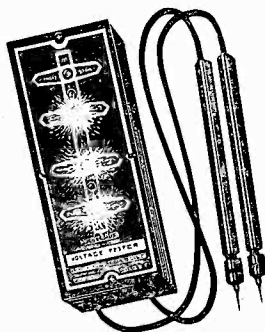

CIRCUIT TESTER uses G-E Glow Lamps to give quick visual indication.

THESE few wiring devices merely hint at the hundreds of ways G-E Glow Lamps are used to add sales appeal to appliances, instruments and electrical equipment of many kinds. The following G-E Glow Lamp advantages may suggest a valuable profit opportunity for you, too:

1. Distinctive orange-red glow—high visibility.
2. Dependable long life—in some types up to 25,000 hours.
3. Low current consumption—as little as 1/25 watt.
4. Low brightness, low heat.
5. High resistance to shock and vibration.
6. Can be installed in small space.
7. Variety of sizes and wattages.
8. Operate directly from regular 105-125 and 210-230 volt circuits, AC or DC.

REMEMBER—Every electrical device should have a live circuit indicator. G-E Glow Lamps are ideal for this purpose.

SEND FOR free bulletin containing full information on G-E Neon Glow Lamps and their application to your product.

G-E LAMPS

GENERAL  **ELECTRIC**

Nela Specialty Div. Lamp Dept., 1 Newark St., Hoboken, N. J.

Non-Insulated Coils

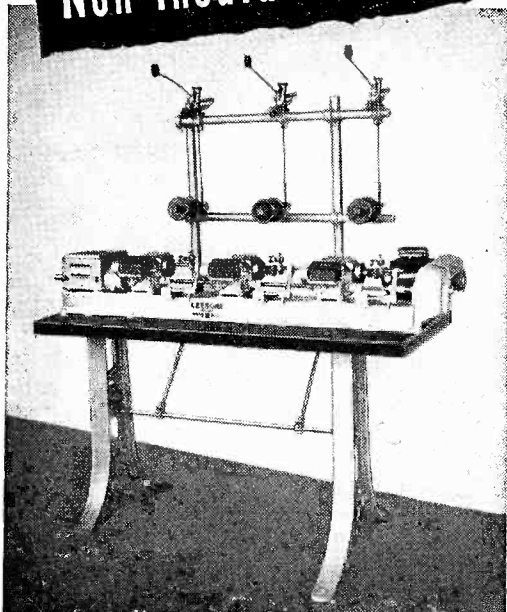

MORE PER HOUR because operator tends three or more heads

On the No. 102 Universal Coil Winding Machine, machine production is synchronized with the time required to perform manual operations.

One operator supervises several winding heads (two to six) simultaneously, and winding is so scheduled that certain heads are producing while manual operations are performed on other heads.

Winds on forms or directly on cores or bobbins . . . each head controlled by electric counter which automatically disengages clutch upon coil completion . . . readily adjustable mechanism for governing wire-layer length, eliminating extra cams . . . traverse changes easily made.

Write for Bulletin 102. Universal Winding Company, P. O. Box 1605, Providence 1, R. I.



*For Winding Coils
in Quantity, Automatically,
Accurately—Use . . .*

29B 6-2

UNIVERSAL WINDING MACHINES

NEW PRODUCTS

(continued)

and 0.150 ampere. Heaters may be operated from an a-c or d-c source. Direct interelectrode capacitances per section for both types are low. Typical operating conditions and characteristics per section for both types are as follows: plate voltage, 250 v; plate current, 6.0 ma; mutual conductance, 3,300 micromhos; amplification factor, 48.

Battery Simulators (24)

SORENSEN & Co., INC., 375 Fairfield Ave., Stamford, Conn. Nobatrons, available in six standard models, operate on a 95-125 volt a-c source of 50 to 60 cycles and provide amperages of 5, 10, or 15 with output voltages of 6, 12, or 28 respectively. Regulation accuracy of one half of one percent, maximum rms ripple voltage of one percent, and recovery

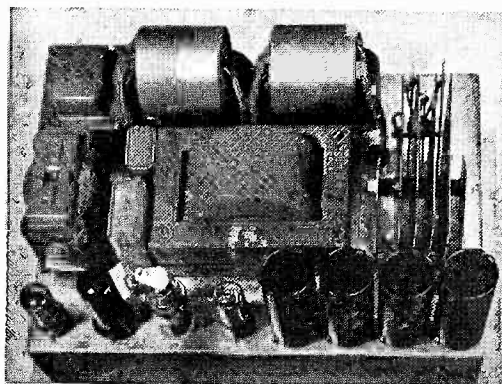

time of one fifth of a second make these devices applicable where constant, unvarying d-c voltages are required. Control features include a switch, a voltage adjustment, a control circuit fuse and a pilot light. Models are available either for panel mounting or encased in a cabinet with a gray wrinkle finish. Further technical specifications are available.

New Attenuator Series (25)

THE DAVEN Co., 191 Central Ave., Newark, N. J. announces a new type of mechanical construction for

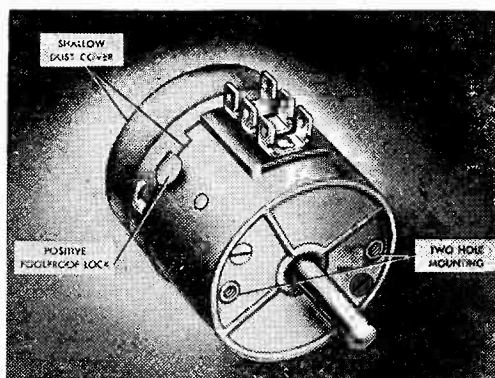

It Costs You Less to Pay a Little More for

SILCOCKS-MILLER PLASTIC DIALS

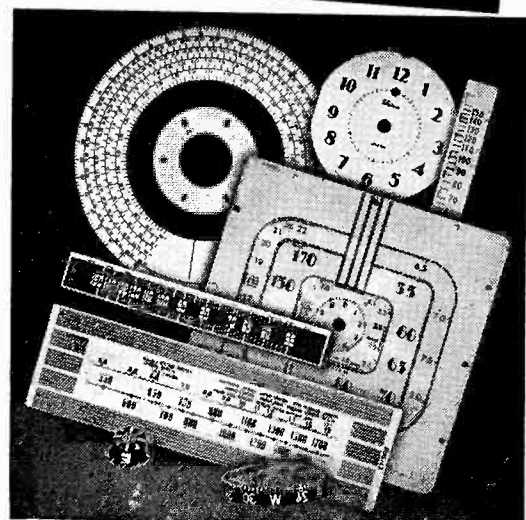

Quality, not quantity is the tradition at Sillcocks-Miller.

Of course, we cannot make all the plastic dials industry requires, so we concentrate on producing only the best.

That's why design engineers who need plastic dials fabricated to close tolerances have come to depend on Sillcock's - Miller craftsmanship through the years.

Our understanding of the problems, our ability to produce accurately and our thorough knowledge of all types of plastics enable us to supply your needs quickly and with a minimum of effort on your part.

That's why we can say "It costs you *less* to pay a little more for Sillcocks-Miller quality."

Write for illustrated brochure today.

THE SILCOCKS-MILLER CO.

10 West Parker Avenue, Maplewood, N. J.
Mailing Address: South Orange, N. J.

SPECIALISTS IN HIGH QUALITY, PRECISION-MADE
PLASTICS FABRICATED FOR COMMERCIAL
TECHNICAL AND INDUSTRIAL REQUIREMENTS.



**Here's a new way
to read meters
...in the dark!**

How often have you wished for a meter you could see *clearly*—the whole scale of it, wherever you were using it—in the dark, under low lights, or even in the kind of glare that causes reflections on the glass—a really illuminated meter? Well, here it is—the result of a new Simpson patented method of illumination.

On these new Simpson Illuminated Meters (voltmeters, ammeters, milliammeters, and microammeters), every fraction of the dial face is flooded with light—there isn't a spot of shadow. And this isn't a dull glimmer of light. It's a full and even radiance.

An ingeniously shaped Lucite cone carries the light from a recessed bulb in the back of the instrument through the front edge that surrounds the entire dial. This makes possible the use of the standard Simpson metal dial. Unlike translucent dials, it cannot fade or discolor so that reading becomes difficult. It cannot warp or buckle, causing the pointer to stick, or distorting readings. The bulb recess is neoprene sealed.

Behind the refinement of this superior illumination lies the basic reason for preferring Simpson instruments—their in-built accuracy. That high quality which is the indispensable component of every Simpson instrument makes sure that the accuracy will *stay* there, year after year.

SIMPSON ELECTRIC COMPANY
5200-5218 W. Kinzie Street, Chicago 44, Illinois
In Canada, Bach-Simpson, Ltd., London, Ont.

Simpson

INSTRUMENTS THAT STAY ACCURATE

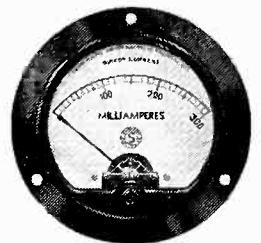

OPEN FACE

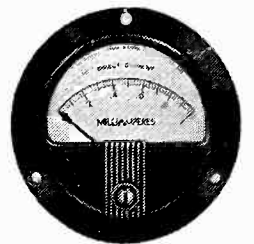

SHROUD STYLE

2" Round Case. Flange diameter, 2-3/4"; depth overall, 2-5/16"; body diameter, 2-11/64"; scale length, 1-7/8".

3" Round Case. Flange diameter, 3-1/2"; depth overall, 2-1/4"; body diameter, 2-3/4"; scale length, 2-9/16".

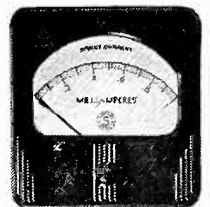

3" Rectangular Case. Width, 3"; height, 3-1/8". Mounts in round hole. Body diameter, 2-3/4".

2" Rectangular Case. 2-3/8" square. Mounts in round hole. Body diameter, 2-3/16".

**HIGH QUALITY
PERFORMANCE!**

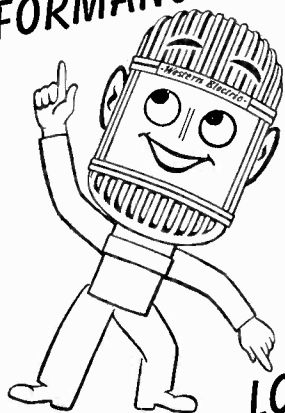

**LOW COST
OPERATION!**

**Western Electric
AM TRANSMITTERS
give you both!**

Whether you want a 250 Watter, a 1, 5 or 50 kw, you'll get the most for your money in a Western Electric AM transmitter. They're tops for high quality and dependability—and right down to rock bottom for operating cost. For technical details and delivery information—write Graybar Electric Co., 420 Lexington Ave., New York 17, N. Y., or...

ASK YOUR LOCAL

Graybar
BROADCAST REPRESENTATIVE

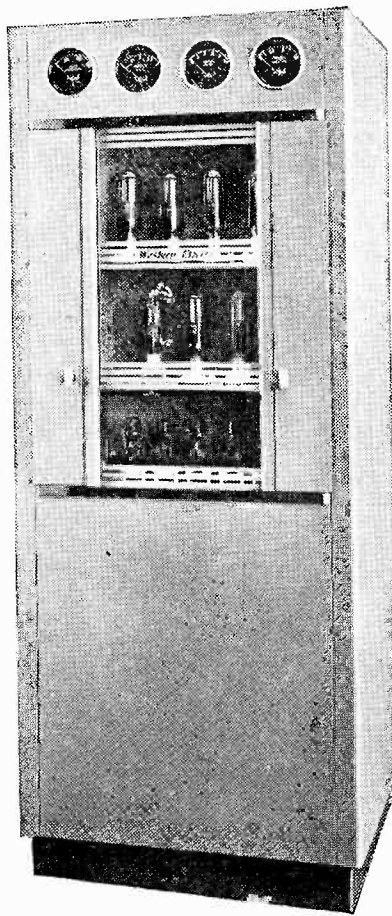

The 451A-1
250 Watt AM transmitter

NEW PRODUCTS

(continued)

their line of attenuators, with such improved features as: a non-ferrous can; a dust-proof housing that is totally shielded; 50 percent less space is required than heretofore to remove the new shallow dust cover, thus permitting the unit to be mounted in a smaller space. All fiber and other moisture absorbing parts have been eliminated. A two hole mounting is standard on the new type units; however, single hole mounting may be secured.

Temperature Control (26)

LEEDS AND NORTHRUP Co., 4934 Stenton Ave., Philadelphia 44, Pa. The new Electromax control consists of a Wheatstone bridge circuit with a vacuum-tube amplifier-detector. Standard ranges of control are 0-250 and 0-1,000 F.

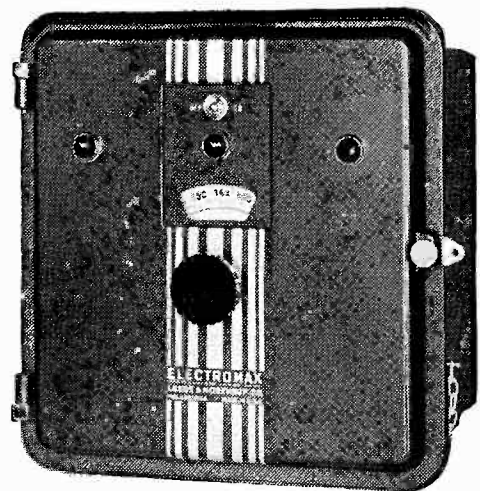

Temperature-sensitive elements are resistance thermometers that can be placed conveniently without regard to lead length affecting calibration. The equipment which is a-c operated is designed for installations where continuous recording is not necessary.

New Intercommunicator (27)

RADIO CORP. OF AMERICA, Camden, N. J. A two-station intercom is designed with amplifier and speaker

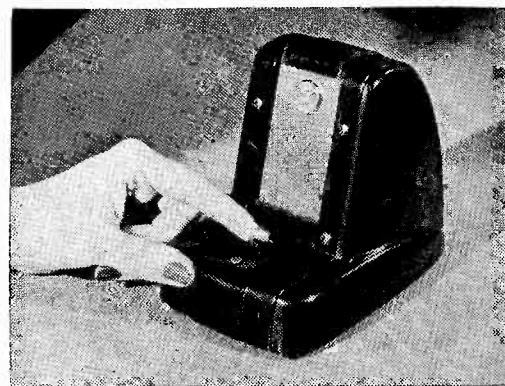

**PLASTIC
FABRICATING
...O.K.!**

**BAKELITE SHEETS, RODS, TUBES
FABRICATED PARTS**

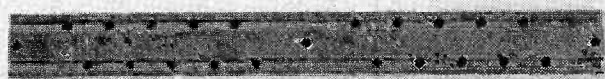
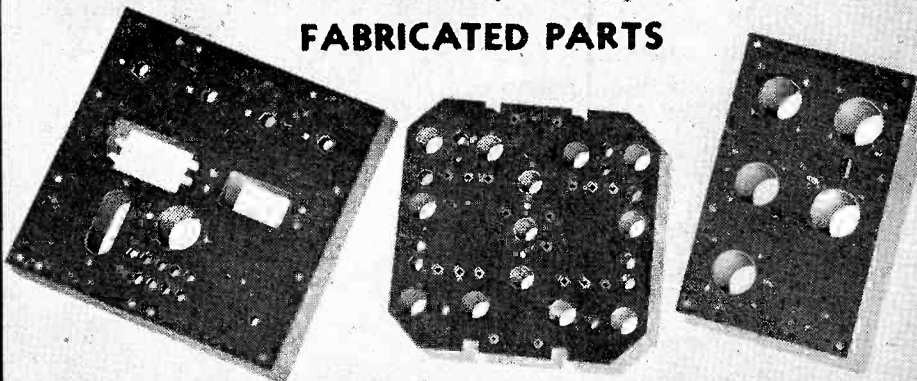

**Twenty Years of Experience
ELECTRICAL INSULATION CO., INC.
12 VESTRY ST., NEW YORK 13, N. Y.**

Fewer "Make-Goods"
 For Wire-Failure
 when you wire with
ROCKBESTOS
 WIRES, CORDS AND CABLES

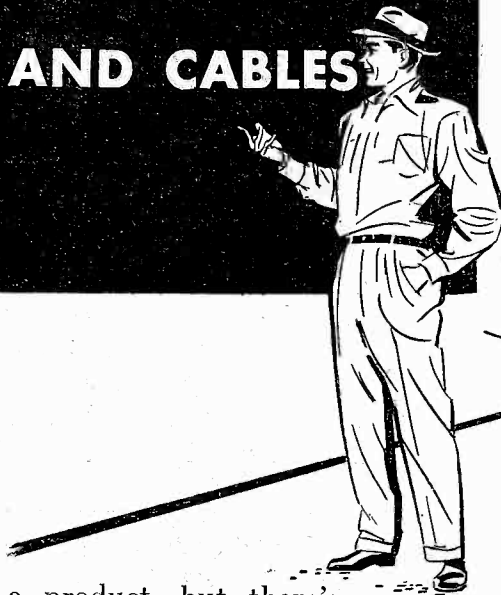

A guarantee may help sell a product, but there's no substitute for quality when *performance has to keep it sold*. That's why permanently insulated Rockbestos wires win friends and influence sales by reducing wire-failure repairs, service calls and replacements.

In heat-generators like waffle irons and rheostats, or products which may be used in failure-creating high ambient temperatures, asbestos insulated Rockbestos wires will operate *continuously* at rated temperatures without drying out, becoming brittle, cracking or flowing. They won't rot under exposure to grease, oil or insulation-destroying fumes. And they are built to outlast products designed to give years of dependable service.

For almost anything you may make, from electronic devices to jet propelled airplanes, there is a *permanently insulated* Rockbestos wire that will help preserve your product's prestige. For recommendations and information write to:

ROCKBESTOS PRODUCTS CORPORATION
 446 Nicoll St., New Haven 4, Conn.



ROCKBESTOS
 The Wire with Permanent Insulation

NEW YORK BUFFALO CLEVELAND DETROIT PITTSBURGH CHICAGO ST. LOUIS LOS ANGELES SAN FRANCISCO SEATTLE PORTLAND, ORE.

A few of the 125 permanently insulated wires, cables and cords developed by Rockbestos to protect product performance and give lasting service.

ROCKBESTOS FIREWALL HOOKUP WIRE

This heat, flame and moisture resistant wire, insulated with high dielectric tapes and impregnated felted asbestos and covered with color-coded, lacquered glass braid, has a maximum operating temperature of 125° C. Ideal for radios, television, amplifiers, calculators or small motor, coil, dynamotor and transformer leads. No. 22 to 4AWG in 1000 volt rating — No. 12, 14 and 16 AWG in 3000 volt rating. Also in twisted pair, tripled, shielded and various special multi-conductor constructions.

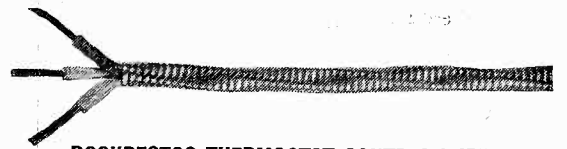

ROCKBESTOS THERMOSTAT CONTROL WIRE

A multi-conductor control wire for fuel burner controls, safety pilots, intercommunications and signal systems. Its asbestos insulation and steel armor assure trouble-free circuits. Sizes No. 14 to 18 AWG in two to five conductors with .0125", .025" or (for 115 volt service) .031" of impregnated asbestos insulation.

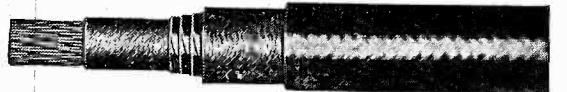

ROCKBESTOS A.V.C. MOTOR LEAD CABLE

Use this 600 volt apparatus cable for coil connections, motor and transformer leads exposed to overloads and high ambient temperatures. Insulated with impregnated felted asbestos and varnished cambric, and covered with a heavy asbestos braid, it is heat-proof and resistant to oil, grease, moisture and flame. Sizes 18 AWG to 1,000,000 CM.

There is a
GENERAL ELECTRIC
CRYSTAL
 for your equipment



- Communications
- FM and AM Transmitters
- Aviation
- Frequency Standards
- Measuring Equipment
- X-ray Equipment
- Electronic Heaters

and
 any other equipment that re-
 quires precise frequency control.

For complete information, write today to:
 General Electric Company, Electronics
 Department, Syracuse 1, New York.

GENERAL ELECTRIC

NEW PRODUCTS

(Continued)

station in separate units, permitting location of the amplifier at any convenient point and reducing speaker station size to that of a desk clock. Speaker stations are newly styled and housed in streamlined black plastic cabinets with satin-chrome speaker grills. Especially designed for such two-station use as communication between executive and secretary, or doctor and receptionist, the system consists of two speaker stations, separate amplifier, and 100 feet of interconnecting wire. It is easily installed and plugs into any 110-volt a-c or d-c outlet. If desired, additional stations up to five can be connected to the amplifier.

Test Leads (28)

THE JFD MFG. Co., 4117 Fort Hamilton Parkway, Brooklyn 19, N. Y. A new line of test leads and test lead accessories contains 15 different numbers of test leads made with fiber and cast phenolic prod handles. They are made of No. 18 soft-drawn copper, insulated with

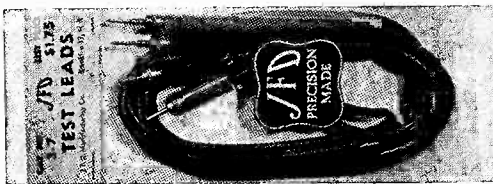

kink-free flexible rubber. All end fittings are made of chromium-plated brass, of types including phone tip, phono needle point, spade lugs, alligator clip, banana plug, and the new elbow angle tips.

Airborne Teletype Equipment (29)

WESTERN ELECTRIC Co., 195 Broadway, New York 7, N. Y. Airborne teletype equipment, developed by Bell Telephone Laboratories and

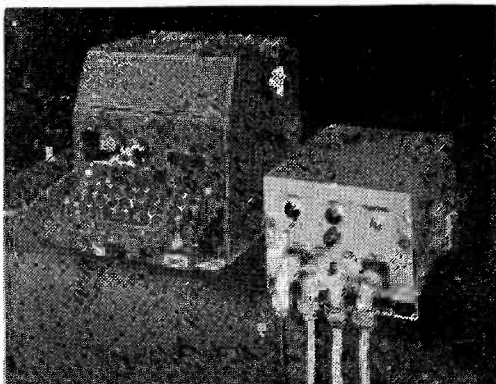

For extraordinary electrical performance

Use SILVER GRAPHALLOY*



THE SUPREME CONTACT MATERIAL



in **BRUSHES**
 for high current density ● mini-
 mum wear ● low contact drop ●
 low electrical noise ● self-lubri-
 cation

in **CONTACTS**
 for low resistance ● non-welding
 character

GRAPHALLOY works where others won't!
 Specify GRAPHALLOY with confidence.

*A special silver-impregnated graphite

GRAPHITE METALLIZING CORPORATION

1055 NEPPERHAN AVENUE, YONKERS 3, NEW YORK

NATVAR *in* CHINA!

NATVAR耐電牌

美國最新式玻璃絕緣管及絕緣帶到
 申敬請全國各大電氣及無線電廠商
 採用最新出品適用於
 PRODUCTS CORP. 製造優點極大保證滿
 各種電氣品之絕緣布絕緣紙等出品均
 備有現貨歡迎選購
 意有徵求本埠特約經理
 中國獨家代理 工貿行
 號南京路沙邊大馬路一四五六

NATVAR ATTENTION

To all electric and radio manufacturers! Best electrical insulating material from the National Varnished Products Corp. of U. S. A. Including Newest Type Extruded Vinyl Tubings, Varnished Cloth, Tapes and Tubes, Varnished Papers, Varnished Fiberglass, Varnished Silk & Rayon. Fresh stock recently arrived for your use.

Sole Agent, (Northern China) —
 China Engineering & Trading Co.,
 Room 124 Sassoon House, Tel. 14536
 Nanking Road, Shanghai.

Sole Agent, (Southern China & Formosa) —
 Gilman & Co., Ltd., Hongkong, China.

This ad appeared in Shanghai newspapers when the first shipment of Natvar insulation arrived after the war.

• Natvar insulating materials are gaining world-wide recognition for the same reason that they are accepted as standard in the United States: Users have found that they can rely on Natvar insulation to be consistently up to specifications or above.

This uniformity is not accidental. It takes constant, continuous, conscientious attention to every last manufacturing and testing detail.

If you require insulating materials with good physical and electrical performance characteristics, and exceptional uniformity—plus prompt delivery—it will pay you to use Natvar. Get in touch with your Natvar distributor or with us direct.



Natvar Products

- Varnished cambric—straight cut and bias
- Varnished cable tape
- Varnished canvas
- Varnished duck
- Varnished silk
- Varnished special rayon
- Varnished Fiberglass cloth
- Silicone coated Fiberglass
- Varnished papers
- Varnished tubings and sleeveings
- Varnished identification markers
- Lacquered tubings and sleeveings
- Extruded Vinylite tubing
- Extruded Vinylite identification markers

Ask for Catalog No. 20

THE NATIONAL VARNISHED PRODUCTS

Corporation

TELEPHONE
 RAHWAY 7-2171

CABLE ADDRESS
 NATVAR: RAHWAY, N. J.

201 RANDOLPH AVENUE

★ WOODBRIDGE NEW JERSEY

**HEXACON
ELECTRIC
SOLDERING
IRONS**

**..tagged for
the big jobs!**

TYPE P-150
(illustrated)

MINNEAPOLIS
HONEYWELL

Westinghouse

Bendix

STROMBERG
CARLSON

Western
Electric

Follow the leaders—and use HEXACON! For rugged, heavy duty work or for light intricate work . . . here's the answer. One reason is "Balanced Heat"—dissipating excessive element-impairing heat—and minimizing element burn-outs and tip replacements. Another is their lightweight. Literature is available describing the complete HEXACON line of screw tip and plug tip irons from 40 to 700 watts, and with tip diameters ranging from 1/4" to 1 3/4".

HEXACON ELECTRIC CO.
130 W. Clay Ave., Roselle Park, N. J.

HEXACON

HIGH-QUALITY, LONG-LASTING SOLDERING IRONS

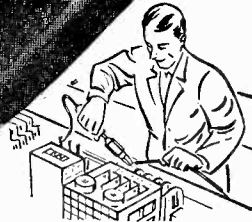

NEW PRODUCTS

(continued)

manufactured by the Teletype Corporation, consists of the Model 31 teletype printer and its associated converter-control unit and adds only 35 pounds to the weight of a plane. The teletype printer illustrated is smaller than a standard typewriter and uses the regular teletype keyboard and signalling code when sending. The converter-control unit changes this telegraphic code into frequency shift signals in the audio frequency range for transmission over existing radio telephone equipment. When receiving, the converter-control changes the frequency shift signals into electrical impulses for operating the receiving-typing part of the teletype printer.

Audio-Frequency Meter (30)

THE DAVEN Co., 191 Central Ave., Newark 4, N. J., announces the new direct-reading frequency meter Type 838. Seven overlapping ranges are available for frequency determination between 20 to 100,000 cycles per second. The accuracy on all ranges is ± 2 percent of the top frequency on the range in use. The instrument has a high input impedance and requires a small minimum voltage for stable indication.

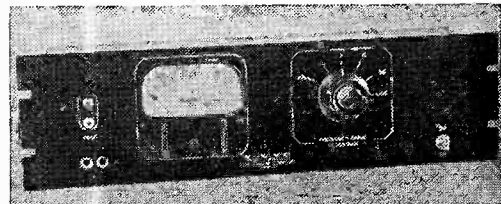

Indication is substantially independent of variations in input voltage between 0.5 and 150 volts rms. The instrument panel is designed for standard rack mounting. A walnut case may be supplied for applications requiring bench use.

Industrial Control Tube (31)

GENERAL ELECTRIC Co., Syracuse, N. Y. The type GL-5545, for use where ambient temperatures range widely, has three major industrial uses: for 220-volt d-c motor control work; in grid-controlled rectifier service; in separate-excitation ignitor circuits. The new tube has a peak-to-average current ratio of 80 to 6.4 amperes and a peak voltage of 1,500 volts. Its inert-gas content

CONNECT 2 to 12 WIRES

BURKE Terminal blocks provide for the centralized connection of numerous wires at one point of control. Sizes are available to handle 2, 4, 6, 8, 10 and 12 wires in one block.

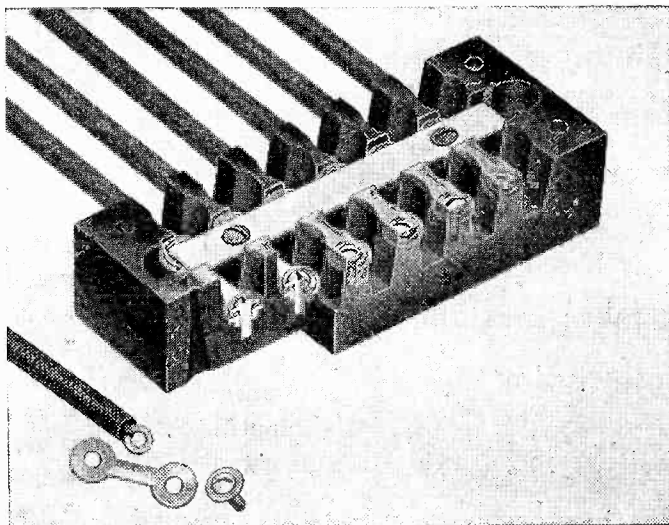

SERIES 2000 is the heaviest design in the Burke Line—has heavy barriers and specially formed slot openings to secure free wire ends without the use of lugs—handles the small wires or stranded cable. Address 1174 W. 12th St.

★ Write for New Booklet



AC AND DC MOTORS AND GENERATORS
BURKE Terminal BLOCKS
BURKE ELECTRIC COMPANY • ERIE, PENNSYLVANIA



In the Magnavox Speaker Laboratory
—measuring resonance of high fidelity
Magnavox speakers.

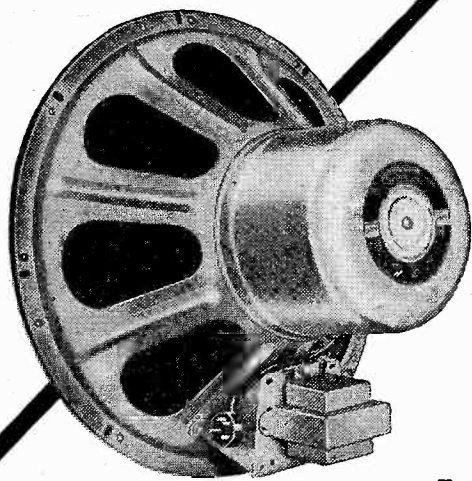

Dynamic Speakers—over 150 models.

WHY quality radio manufacturers choose Magnavox components

NOT only consumer goods bearing the Magnavox name, but many another quality radio and radio-phonograph utilizes Magnavox speakers and capacitors. The name Magnavox is long established—since 1915—as the symbol of quality in radio manufacture.

The oldest and largest manufacturer of loud-speakers, Magnavox has achieved a breadth of “know how” experience unsurpassed in the radio industry. Six acres of modern plant and equipment, a competent

staff of trained engineers and designers, plus 32 years of research and development now stand ready to be applied to any of your component problems. Your specifications are expertly studied and followed.

When you need loud-speakers, capacitors, solenoids or other electronic equipment, specify the name Magnavox—specialists in quantity production of quality components for the manufacturing trade. The Magnavox Company, Components Division, Fort Wayne 4, Indiana.

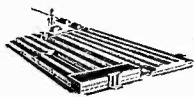

Magnavox

has served the radio industry for over 32 years

SPEAKERS • CAPACITORS • SOLENOIDS • ELECTRONIC EQUIPMENT

MASTER-PRO

Meets All NAB Standards

The QUALITY Transcription and Recording Equipment

ALL NEW POST-WAR MODELS

MODEL "V"

Recording Turntable Illustrated

MODEL "M-5"

Recording Mechanism Illustrated Mounted



"MASTER-PRO" M-5 RECORDING MECHANISM WITH CUTTER

RUGGEDNESS: Fifteen pounds of steel and bronze, chrome plated, assures long wear and the ability to stand up against rough treatment.

QUALITY: The "Master-Pro" M-5 is machined to tolerances unheard of in pre-war production.

The "Master-Pro" M-5 is a universal machine that can be readily attached not only to the Master-Pro V Recording turntable, but to any other make of turntable that has the standard center pin.

Standard screw cuts 120 line per inch outside-in. Feed screws for 105 or 120 line outside-in or inside-out, substituted at purchaser's request.

Model M-5 with magnetic cutter...\$175
with Brush RC-20 crystal cutter...\$175

"MASTER-PRO" MODEL-V 16" RECORDING TURNTABLE

SPECIFICATIONS:

14-lb. L-ribbed cast iron chassis.
Lathe turned aluminum cast turntable.
New specially constructed smooth powerful constant speed motor.
Neoprene idlers\$165.44
Model G-2 Transcription Turntable\$125

"MASTER-PRO" VM-2 RECORDING LEVEL METER



Mounted in an unbreakable, cast aluminum case, the VM-2 Recording Level Meter takes recording out of the hands of the expert. It enables the artist to watch the volume of his recording while performing and is readable up to 25 feet. The possibility of overcutting is reduced to a minimum. Wired to operate from the output of an 8, 15, 200 or a 500 Ohm amplifier. \$29.50

Telephone: **LO. 3-1800**

HARVEY RADIO COMPANY INC.

103 West 43rd St., New York 18, N. Y.

NEW PRODUCTS

(continued)

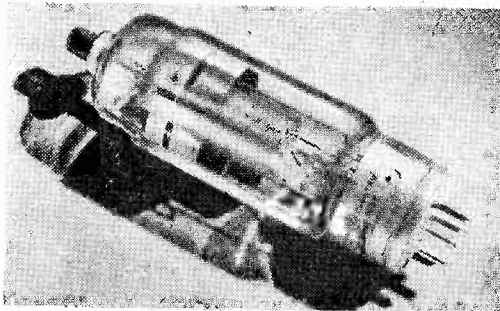

makes possible a short heating time of 60 seconds. Filament voltage is 2.5 volts and filament current is 21 amperes.

Set Tester (32)

STAR MEASUREMENTS Co., 442 East 166 St., New York 56, N. Y. A new combination tube and set tester, model MT-12, provides for the checking of radio receiving and allied use tubes. The unit measures tube noise and capacitor leakage. The multitester section provides 27 ranges of voltage, current, and re-

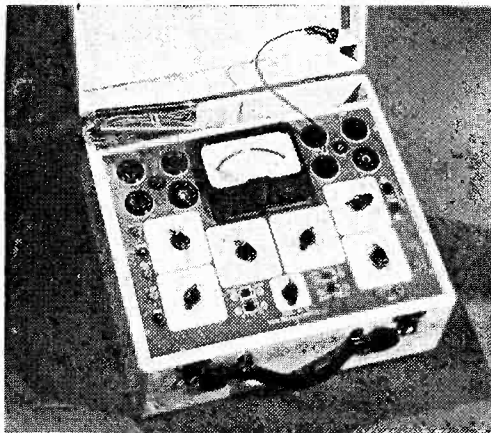

sistance measurements. The entire instrument is housed in a wooden cabinet with removable cover, and is provided with a separate compartment for the storage of line cord and test leads. The size is 14 x 12 x 6 inches and it weighs 10 pounds.

Linear Ganged Potentiometer (33)

FAIRCHILD CAMERA AND INSTRUMENT Corp., Jamaica, N. Y., has announced an improved linear wire-wound potentiometer, now available

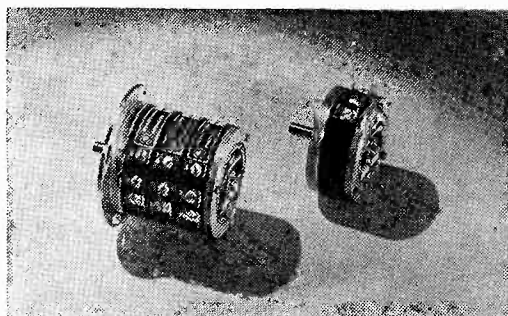

EASY ON THE EAR WITH

Smooth Power

• That's what counts with your customers! Give them faithful reproduction, free from wow and rumble, and your selling job will be easier and more profitable.

You'll get that fine performance from our complete *Smooth Power* line of phonomotors, recorders and combination record-changer recorders. They're carefully engineered and faithfully built for quick pick-up, constant speed and freedom from noise and vibration. They're *easy on the ear*.

They'll make fitting companions for your own fine products.

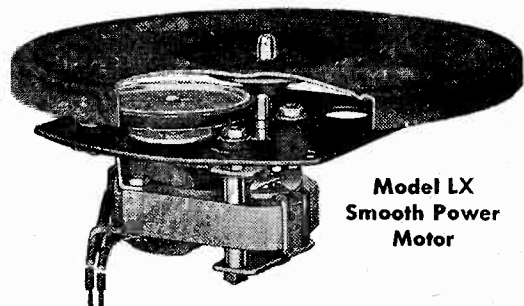

Model LX Smooth Power Motor



THE GENERAL INDUSTRIES CO.

DEPT. ME • ELYRIA • OHIO

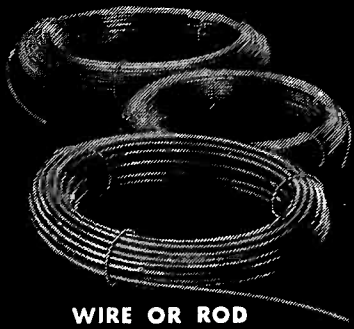

WIRE OR ROD

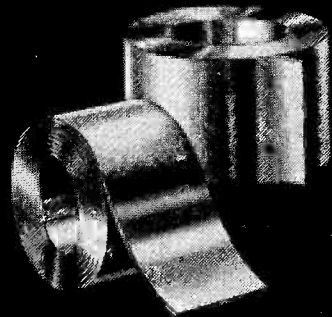

SOLDER STRIP



POWDERED SOLDER



BURRED SOLDER

SILVER SOLDERS

for

SPEED • ECONOMY • DURABILITY

The D. E. Makepeace Company has long pioneered in the development of silver solders. With more than a half century of accumulated experience behind us, we have, today, developed a variety of silver-brazing alloys to meet practically every industrial requirement.

These solders flow easily, penetrate deeply and diffuse evenly. The joints so affected are stronger, in most instances, than the parts joined and the junction is durable, ductile, leakproof, corrosion resistant, and high in electrical and thermal conductivity.

Today, preplaced solder rings or solder washers and induction heating are revolutionizing former soldering methods. Likewise, modern alloys and light gauge metals, likely to be damaged by high temperature brazing or welding, have been particularly aided by the use of our low temperature, fast spreading silver solders.

Should you have a special soldering or brazing problem, our fully equipped research and testing laboratory is at your service. Our informative folder listing precious metal solders, with helpful melting and flow-point tables, will be sent you upon request.

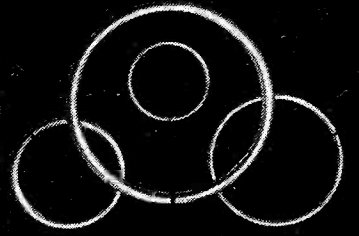

SOLDER RINGS

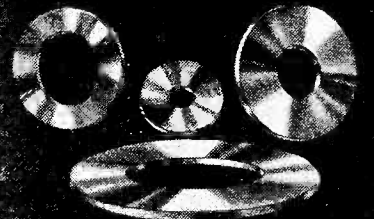

SOLDER WASHERS

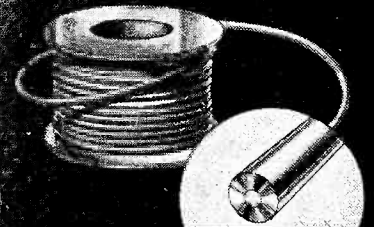

SOLDER FILLED
WIRE

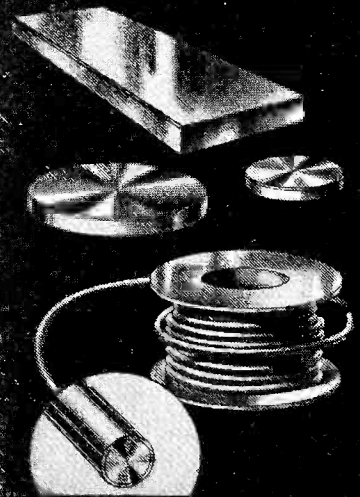

SOLDER FLUSHED
SHEET • DISCS • WIRE



Makepeace PRODUCTS

SHEETS • WIRE • TUBING • SOLDERS • FABRICATED PARTS AND ASSEMBLIES

D. E. MAKEPEACE COMPANY

Main Office and Plant, Attleboro, Massachusetts

NEW YORK OFFICE, 30 CHURCH ST. CHICAGO OFFICE, 55 EAST WASHINGTON ST.

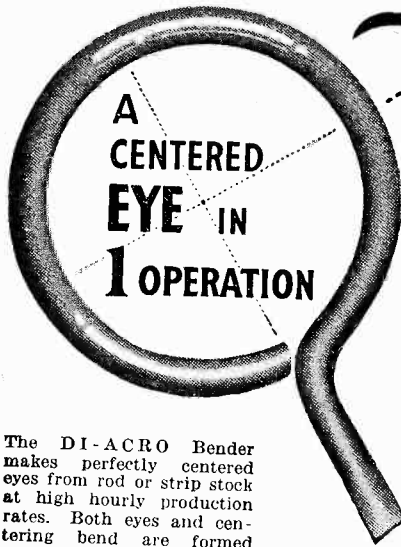

Precision CENTERED EYE Bending

With DI-ACRO Benders

The DI-ACRO Bender makes perfectly centered eyes from rod or strip stock at high hourly production rates. Both eyes and centering bend are formed with one operation. Any size eye may be formed within capacity of bender and ductile limits of material.

DI-ACRO Precision Bending is accurate to .001" for duplicated parts. DI-ACRO Benders bend angle, channel, rod, tubing, wire, moulding, strip stock, etc. Machines are easily adjustable for simple, compound and reverse bends of varying radii.

DI-ACRO Bender No. 1

Forming radius 2" approx. Capacity 7/32" round cold rolled steel bar or equivalent.

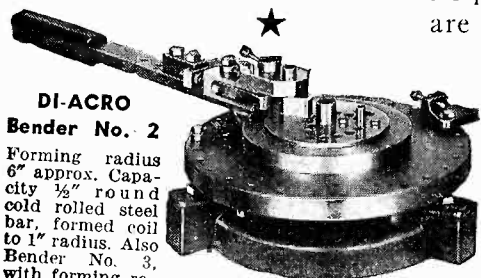

DI-ACRO Bender No. 2

Forming radius 6" approx. Capacity 1/2" round cold rolled steel bar, formed coil to 1" radius. Also Bender No. 3, with forming radius 9" approx.

Send for CATALOG "DIE-LESS" DUPLICATING showing many kinds of "dieless" duplicating produced with DI-ACRO Benders, Brakes and Shears.



DI-ACRO is Pronounced "DIE-ACK-RO"

DI-ACRO PRECISION MACHINES DIE-LESS DUPLICATING
O'NEIL-IRWIN MFG. CO.
 321 Eighth Avenue • Lake City, Minnesota

ANTENNA SYSTEMS for USERS of PRIVATE BRANDS



We manufacture the following, under private labels and trademarks:

- AUTOMOBILE ANTENNAS** . . . every variety, including types that can be raised and lowered from inside the car.
- RESIDENTIAL ANTENNAS** . . . AM and FM, for homes, stores and multi-family buildings. Complete lines of noise-reducing systems incorporating latest patented developments of coupling transformers.
- FM, AM and TELEVISION** . . . Dipoles with or without reflectors, folded dipoles, turnstile, radiating types and other combinations for roof, sidewall and other mountings.
- MARINE ANTENNAS** . . . Collapsible and transmitting types for every purpose.
- For POLICE and other mobile units** . . . roof-top antennas for ultra-high frequencies.

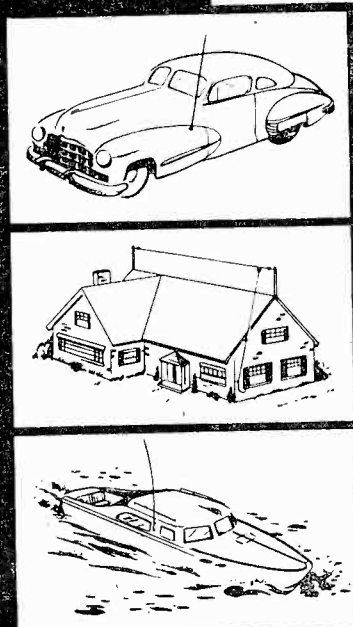

WE INVITE INQUIRIES AND CONSULTATIONS.

L. S. BRACH MFG. CORP.
 200 CENTRAL AVENUE NEWARK, 4 N. J.
 WORLD'S OLDEST AND LARGEST MANUFACTURERS OF RADIO ANTENNAS AND ACCESSORIES

in single units or ganged in multiple on one shaft to provide independent voltage outputs for several related variables. The instrument obtains an accuracy of 0.1 percent in the three-inch size, No. 748, and 0.15 percent in the two-inch, No. 747. Service life is generally guaranteed to exceed 1,000,000 cycles. This accurate single or ganged linear potentiometer is intended for communication equipment; sound recording equipment; servomechanisms; computing gunsights; radar navigational equipment; telemetering. Further specifications are available.

Multiple Test Meter (34)

GENERAL ELECTRIC Co., Syracuse, N. Y. A new Unimeter, Type YMW-1A has been designed for rapid, accurate measurement of volts, at 20,000 ohms, current and decibels. All functions of this nine-pound equipment except the 50 microampere and output meter capacitor jacks are available without changing the test



leads. Specifications include resistance with a total coverage of 1 ohm to 20 megohms; voltage, a-c and d-c, 0-1,000 volts; current, 0 to one-half ampere; decibels, minus 4 to plus 62, all designed in convenient ranges.

Small Oscilloscope (35)

WATERMAN PRODUCTS Co., Inc., 2445 Emerald St., Philadelphia 25, Pa. The new model S-11-A Pocketscope is the second of a series of compact oscilloscopes designed for industrial and television measurements. It differs from the model S-10-A in having a 3-inch cathode-ray tube rather than a 2-inch type and in its greater versatility. Both a-c and d-c measurements are possible. Push-pull amplifiers for horizontal and

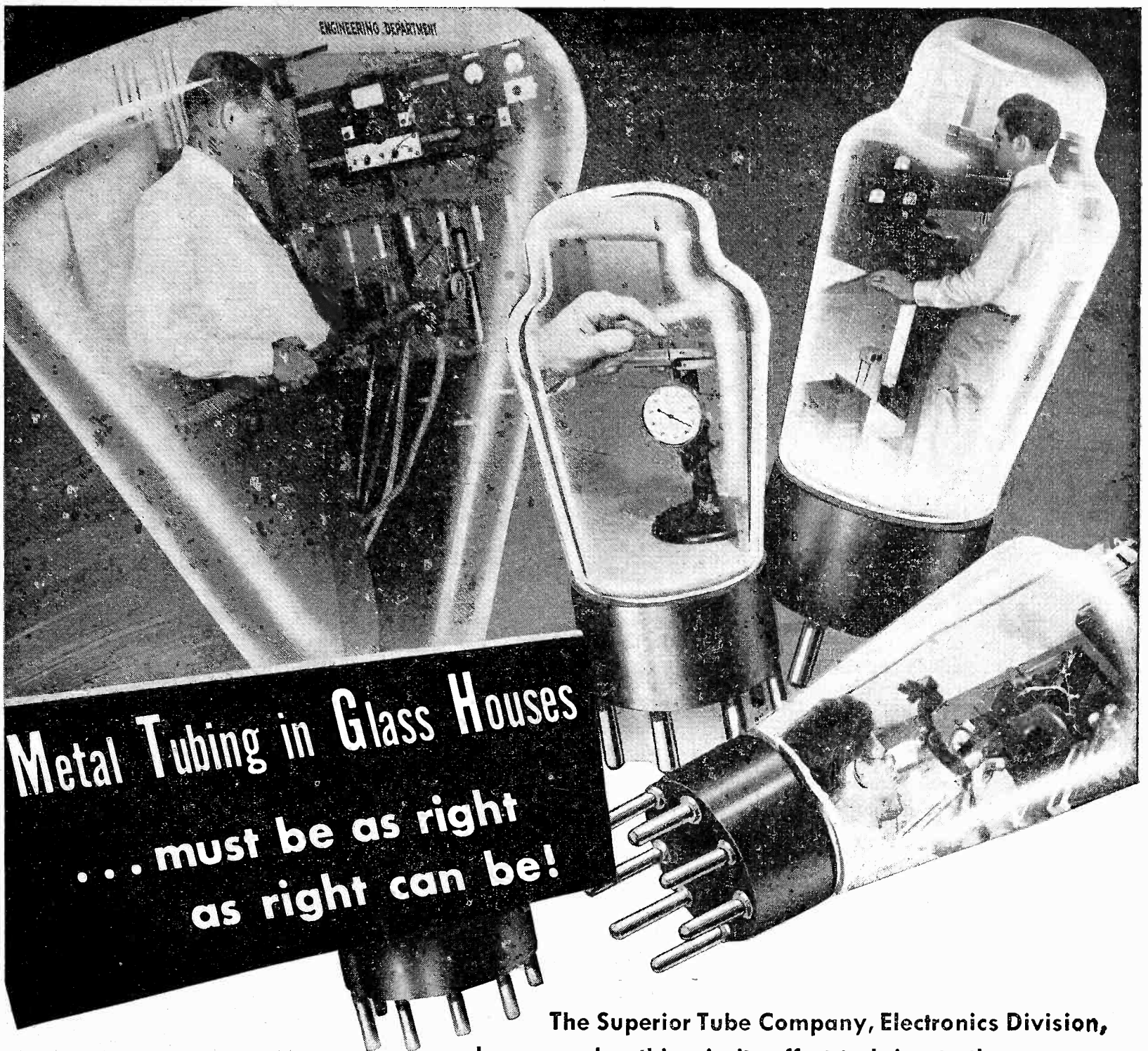

Metal Tubing in Glass Houses
 ... must be as right
 as right can be!

The Superior Tube Company, Electronics Division, has spared nothing in its effort to bring to the Radio Tube Industry, through its highly specialized facilities, metal tubing in the form of cathodes, anode and grid cylinders, and all types of fabricated tubular parts. These products, used in all types of electron tubes, are the metallurgical and physical counterparts of your electronic expectations. • Material control standards, otherwise unattainable, are now realities. Superior's Electronics Laboratory has made possible far-reaching research and development of electronic tubing, through the study of materials, processes and controls. • Whatever your requirements in metal tubing for electron tubes, bring your problems to us. The Engineering Staff of Superior Electronics Division will welcome your inquiries and the privilege of working with you.

THE BIGGER NAME IN

SMALL TUBING
Superior

**SUPERIOR TUBE COMPANY
 ELECTRONICS DIVISION**

Post Office Drawer 191 • Norristown, Pa.
 Telephone, Norristown 2070



**TYPE
50**

1. Precision Engineered
2. Rugged, Durable, Long-lived
3. Efficient, Dependable Operation
4. Economical

Every conceivable type of Socket and Jewel Light Assembly is available at DRAKE... all measuring up to the same high quality standards. We make over 950 different kinds of Mounting Brackets, to bring lamp filaments into desired positions. Should a new application call for a special design of Assembly or Bracket, our skilled engineers will work with you to design a unit to meet your specific needs. DRAKE quality, dependability and patented features are widely known and appreciated among those who know Socket and Jewel Assemblies best. Very large high speed production facilities assure reasonably prompt deliveries in any quantity. Write or wire for samples and full information.

ASK FOR OUR NEW CATALOG • NO OBLIGATION!



**Socket and Jewel
LIGHT ASSEMBLIES**

**DRAKE
MANUFACTURING CO.
1713 W. HUBBARD ST., CHICAGO 22**

NEW PRODUCTS

(continued)

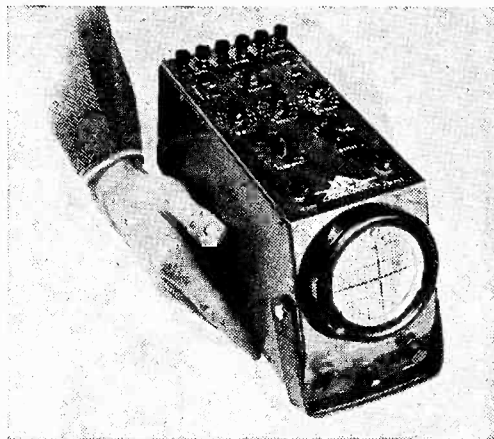

vertical deflection, an intensity modulation amplifier, and a linear time sweep from 3 cycles to 50 kilocycles are among the features. Direct connections to deflecting plates and intensity grids are accessible from the rear. The instrument retails for \$99 fob Philadelphia.

Transmission Line (36)

AMERICAN PHENOLIC CORP., 1830 South Fifty-Fourth Ave., Cicero 50, Ill. Amphenol 14-023 polyethylene twin-lead consists of a pair of parallel stranded conductors encased and spaced by a dielectric.

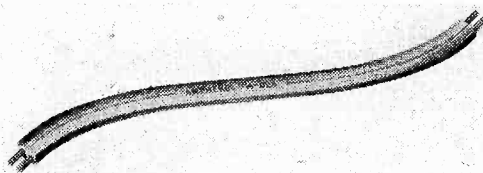

When the line's surge impedance of 75 ohms is mismatched, the conductors will carry a kilowatt of energy. With a standing wave ratio of two-to-one, twice the power can be handled. The conductors are so closely spaced as to substantially eliminate radiation at frequencies up to several hundred megacycles.

Incremental Inductance Bridge (37)

INDUSTRIAL TRANSFORMER Corp., 2540 Belmont Ave., New York 18, N. Y. The model 220 incremental inductance bridge permits testing of self-inductance, regardless of Q, with an overall accuracy better than 1 percent. Any inductance between 1 millihenry and 20 henrys can be measured with any value of superimposed d-c between 0 and 1 ampere. From 20 to 200 henrys the maximum current is limited to 250 milliamperes; over 200 henrys the

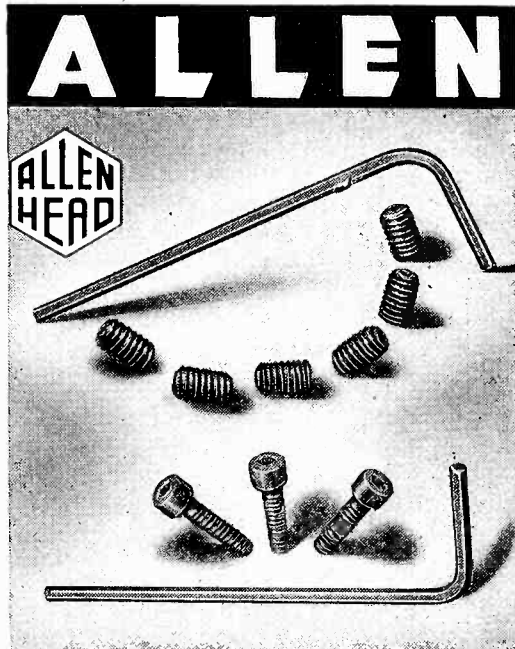

**Set and Cap Screws
in numbered sizes — 2 to 10
and 1 to 10 respectively —
strongest of fine fastenings**

Fine in size, finer in appearance than projecting head or slotted screws. Finest for durable assemblies because their heat-treated hex socket-walls allow tighter set-ups than other-type screws of comparable size.

The Set Screws have die-cut threads accurate to a high Class 3 fit, with perfectly-formed hex sockets. The screws can be held on either end of the handy hex keys and turned into the tapped hole without fingering. Allen Hand Drivers are available to facilitate fast assembling.

The Cap Screws are Allen "pressur-formed" for maximum strength of head and socket. This process makes the steel-fibres conform to the shape of the head, — no cut fibres. Threads also formed by pressure-process to a high Class 3 fit, ensuring a high degree of frictional holding-power.

In radio and television sets, radio telephones, radar equipment, electronic controls, these screws HOLD fine adjustments and intricate assemblies.

Order of your local Industrial Distributor

**THE ALLEN MFG. CO.,
HARTFORD 1, CONN., U. S. A.**

Total Energy Radiation in Watts
Per Square Centimeter

for
thermal
emissivity

**SPEER GRAPHITE ANODES
BEAT METAL**

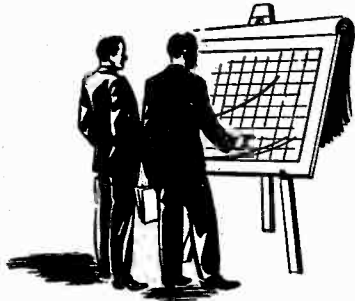
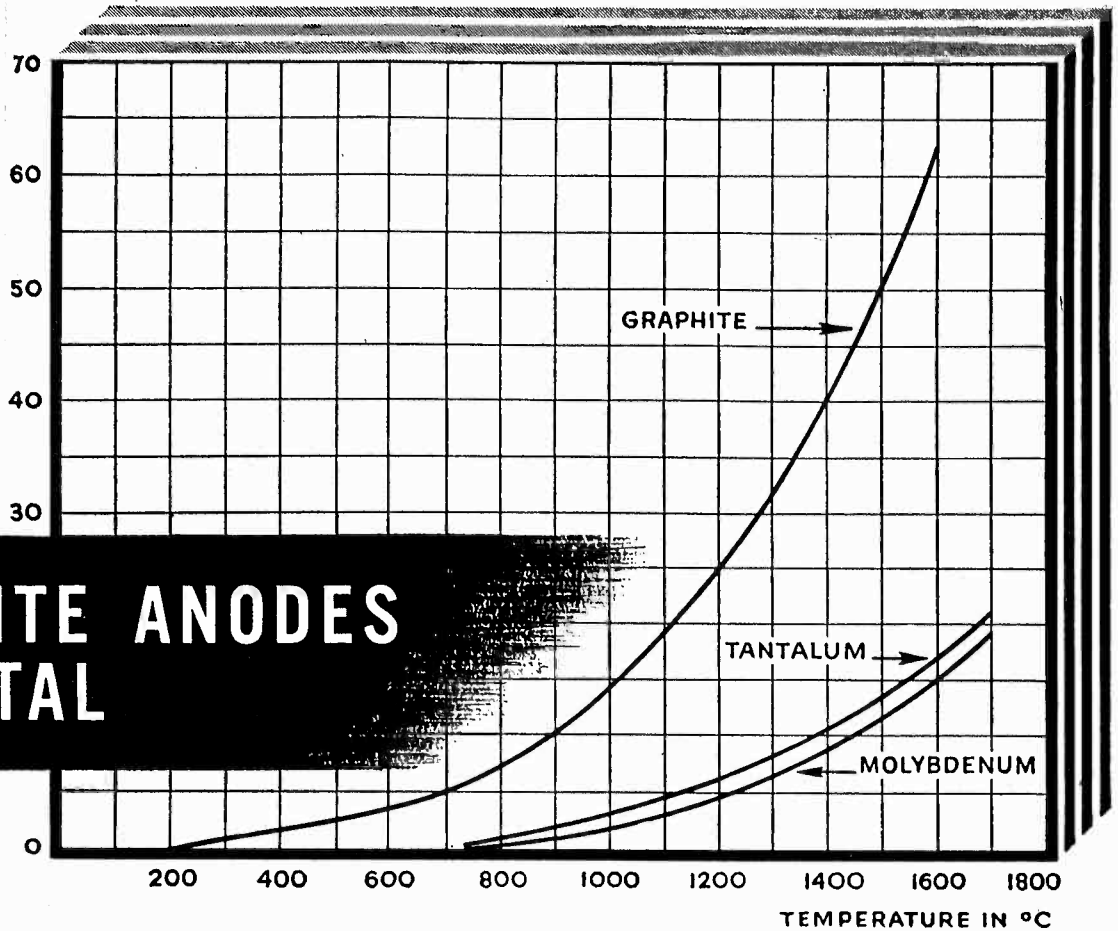

... in power and rectifying tubes

GRAPHITE Anodes offer much higher thermal emissivity than metallic anodes—tantalum, tungsten and molybdenum. So Graphite Anodes dissipate far larger amounts of energy at lower temperatures than do metallic anodes. This property gives Graphite Anodes a reserve of plate dissipation that enables them to carry large overloads. Tubes with Graphite Anodes have proved invulnerable to overloads of several times their normal rating!

Graphite Anodes are proved rugged, stand up to mechanical and electrical abuse. The advantages of Graphite Anodes add up to all-around operating superiority and longer tube life. These advantages are yours ... specify tubes with Graphite Anodes!

Ⓜ 2428

Speer

**CARBON COMPANY
ST. MARYS, PENNA.**

**Makers of the Finest Graphite Anode Tubes
specify SPEER GRAPHITE**

brushes • contacts • welding electrodes • graphite anodes • rheostat discs • packing rings • carbon parts
CHICAGO • CLEVELAND • DETROIT • MILWAUKEE • NEW YORK • PITTSBURGH

ADVANCE Plug-in Relays

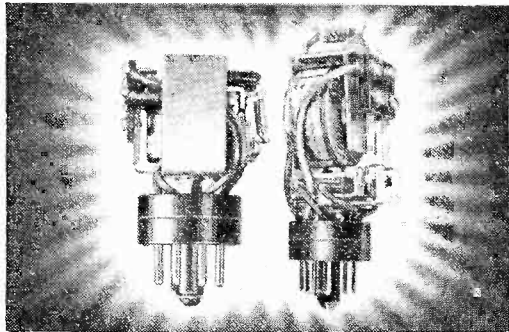

During the war, unit interchangeability was widely applied as a design concept to speed repairs when time was of the essence. Advance now extends this war-born trend to the manufacture of better relays.

Advance plug-in's make rapid replacement a simple matter . . . especially desirable when time out for maintenance must be kept at a minimum or when relays must be mounted in hard to reach places.

Thirteen Advance relays can now be obtained, mounted as shown above, on regular speaker plugs. Protector grips are standard on small relays . . . optional on large. Connections are arranged to make contact combinations interchangeable. Dust caps are available at slight extra cost.

Further details and free catalog on request.

Advance Relays

ADVANCE ELECTRIC & RELAY CO.
1260 West 2nd St., Los Angeles, California • Phone Michigan 9331

the Ideal Inductors for

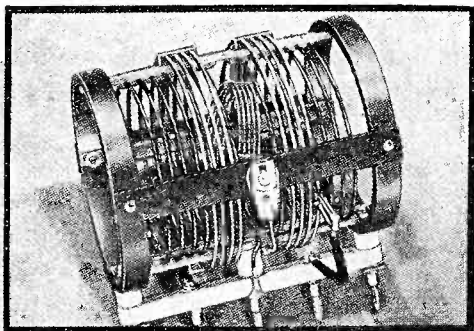

powers up
to 500 Watts

**B&W "3400"
SERIES**

More flexible electrically . . .

Exceptionally sturdy physically . . .

For precise loading and impedance matching, the B&W series 3400 coil is tops. 80 and 40 meter coils have tapped external fixed links in series with internal rotary links. 20, 15, and 10 meter coils have internal rotary links only. All coils will load and properly match power amplifiers of 500 watt rating to lines having an impedance of from 50 to 750 ohms. Once adjusted, the coil coupling remains constant. No further adjustment is necessary when bands are changed. Exceptional physical protection is obtained by B&W wartime "armored" construction.

Write for Catalog

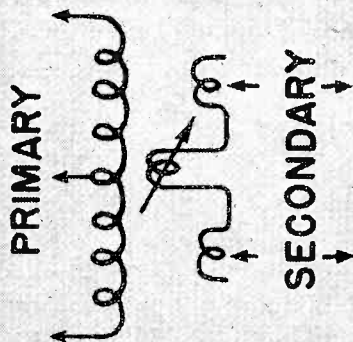

BARKER & WILLIAMSON

B&W

237 FAIRFIELD AVE., UPPER DARBY, PA.

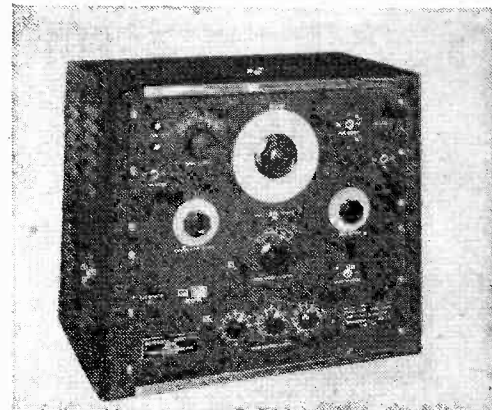

maximum current is 25 milliamperes. Three types of connection, Owen, Hay and Maxwell, are possible. A standard decade resistance box up to 100,000 ohms will extend the maximum value of inductance that can be measured at 1 ampere from 20 to 100 henrys.

General Purpose Microphone (38)

ELECTRO-VOICE, INC., Buchanan, Michigan. A new model 905 crystal microphone at low cost for general sound work has a frequency response substantially flat between 50 and 7,500 cycles and an output level 54 db down. At low audio frequencies the polar pickup pattern is nondirectional, but becomes directional at high frequencies. Head is fixed at a tilt of 22 degrees. The

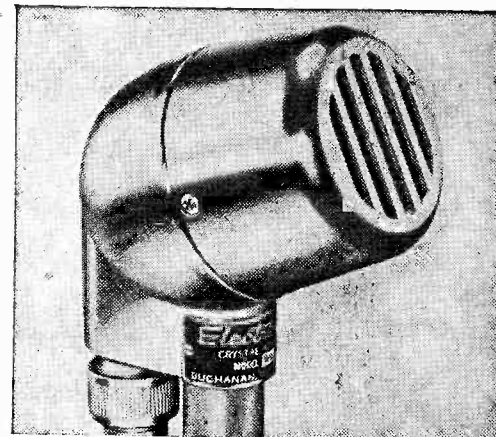

model 905-8 furnished with eight feet of cable and the Model 423-A desk stand makes a convenient combination for radio amateur use and lists at \$16.50. Further details are given in Catalog No. 101.

Portable CRO (39)

RADIO CORP. OF AMERICA, Camden, N. J. A new portable general purpose oscilloscope, Type WO-79A, makes possible the accurate measurement and display of frequency components up to six megacycles in

THE VITAL LINK IN EVERY INDUSTRY...

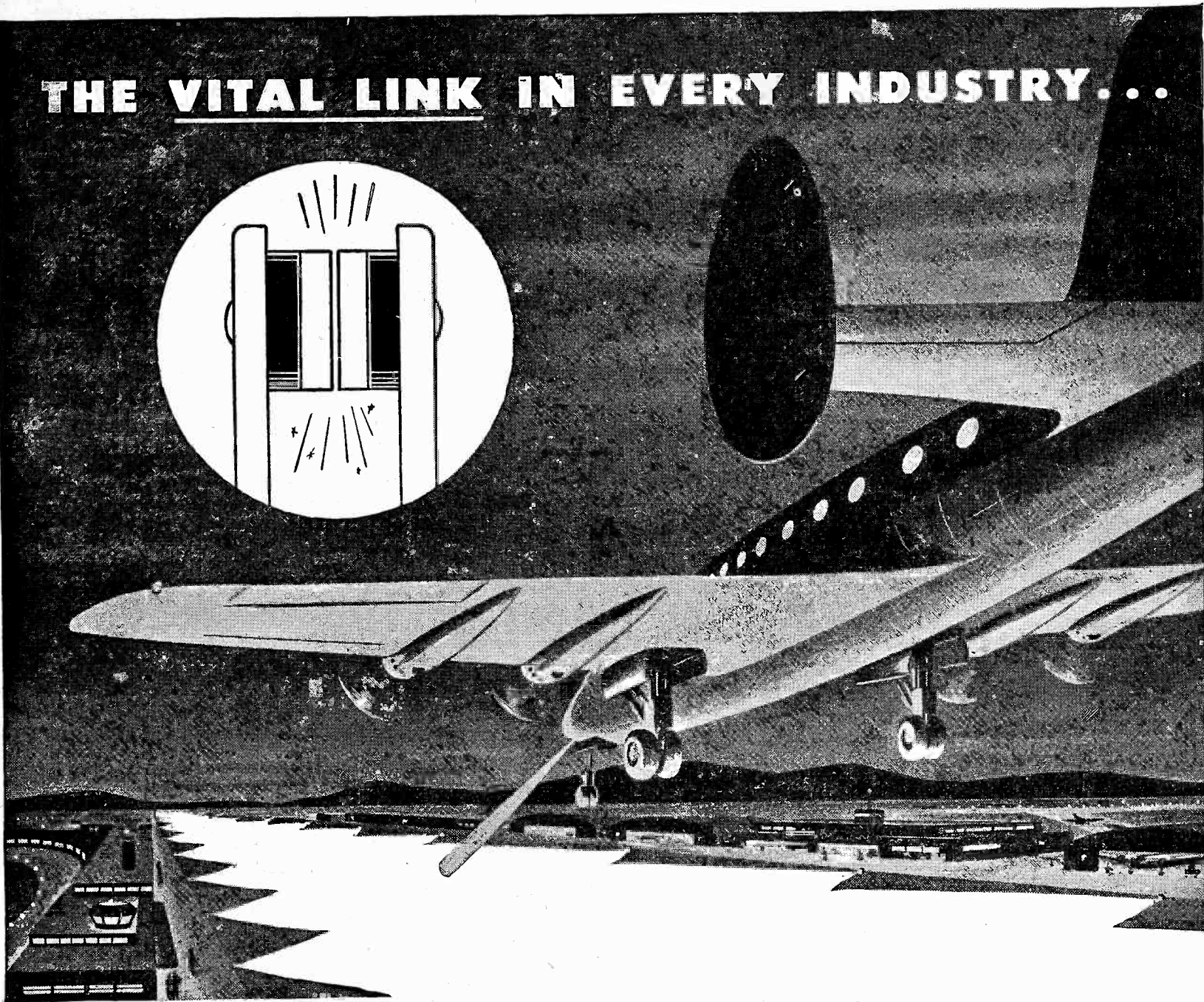

WILCO CONTACTS

They keep the power flowing!

Today WILCO CONTACTS keep the power flowing in vital industrial applications through their *built-in* capacity for precision performance and longer service life. WILCO CONTACTS function dependably in frequency operations of every range by bringing to each operation requisite ductility, hardness, density, freedom from sticking, low metal transfer, high conductivity and arc-resistance.

You likewise can depend on WILCO CONTACTS to keep the power flowing in your products, because exclusive patented WILCO processes assure unequalled qualities. WILCO engineers will gladly help you select from a great variety of available WILCO contact materials the particular contacts suited to your needs—or develop new alloys for special purposes.

THE H. A. WILSON COMPANY

105 Chestnut Street, Newark 5, N. J. • Branch Offices: Chicago, Detroit, Los Angeles, Providence

WILCO PRODUCTS INCLUDE:

CONTACTS

Silver - Platinum - Tungsten - Alloys
Sintered Powder Metal

THERMOSTATIC BIMETAL

All temperature ranges, deflection
rates and electrical resistivities.

SILVER CLAD STEEL JACKETED WIRE

Silver on Steel, Copper, Invar or
other combinations requested.

ROLLED GOLD PLATE AND WIRE

SPECIAL ALLOYS

NI-SPAN C*

New Constant Modulus Alloy

*Reg. Trade Mark, The International Nickel Co., Inc.



SPECIALISTS FOR 30 YEARS IN THE MANUFACTURE OF THERMOMETALS • ELECTRICAL CONTACTS • PRECIOUS METAL BIMETALLIC PRODUCTS

AT YOUR SERVICE

TO HELP YOU WITH YOUR SHEET METAL FABRICATION REQUIREMENTS.

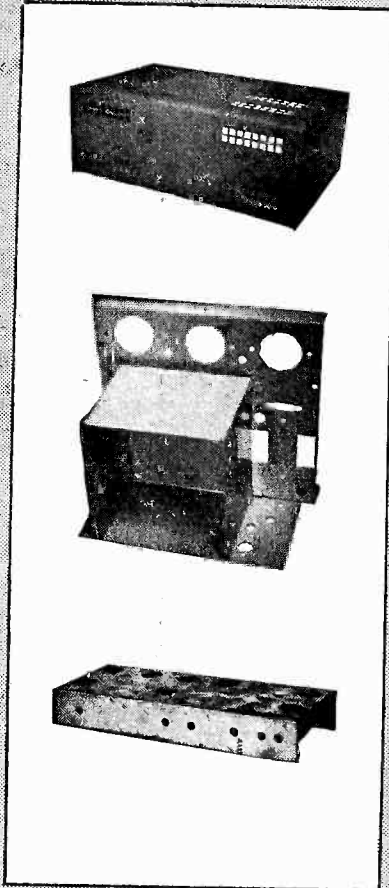

SHEET METAL PRODUCTS — such as:

INSTRUMENT PANELS, RADIO COMMUNICATION CASES and ENCLOSURES, OSCILLATOR BOXES, CHASSIS and CABINET ASSEMBLIES RACKS and SPARE PARTS BOXES, WATERPROOF CABINETS and BOXES, METAL STAMPINGS, FORMING and WELDING of FERROUS and NONFERROUS METALS.

We can assure you of excellent workmanship and prompt deliveries. Send us your blueprints and specifications. We shall quote you immediately.

S. Walter Co.

PRECISION SHEET METAL PRODUCTS
144 - 146 CENTRE STREET
BROOKLYN 31, NEW YORK
Tel. MAin 4-7395

NEW PRODUCTS

(continued)

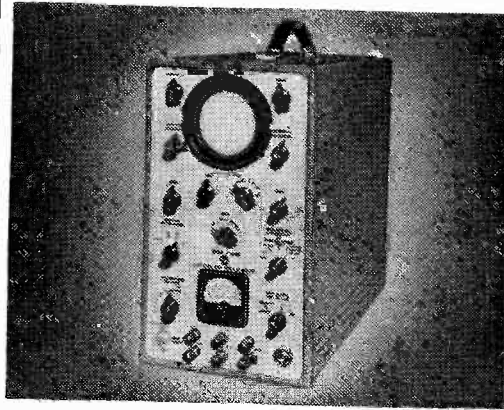

transient and pulsed voltages of the order of one microsecond. The major electrical components of the new oscilloscope include calibrated horizontal and vertical input attenuators, high-gain horizontal and vertical amplifiers, a synchronizing amplifier, a time-base oscillator and sweep generator, and intensifying amplifier, low voltage and high voltage power supplies, and a three-inch high-contrast cathode-ray oscilloscope. A triggered sweep makes the unit suitable for photographic study of transient waveforms, for television signal expansion for checking square-wave time, and for checking irregularly timed pulses. The intensifying amplifier increases the brilliancy of the waveform after the time-base generator is triggered, permitting examination and photography of small, otherwise, faint, and extremely short pulses.

Portable Transcription Player (40)

U. S. RECORDING Co., 1121 Vermont Ave., N.W., Washington 5, D. C. The Panacoustic portable transcription player designed and built for broadcasting stations and advertising agencies plays 6 to 16 inch records and transcriptions at both 33½ and 78 rpm. The 12 inch turntable is amazingly smooth and silent. The lightweight pickup, with permanent sapphire stylus, assures reproduction with practically

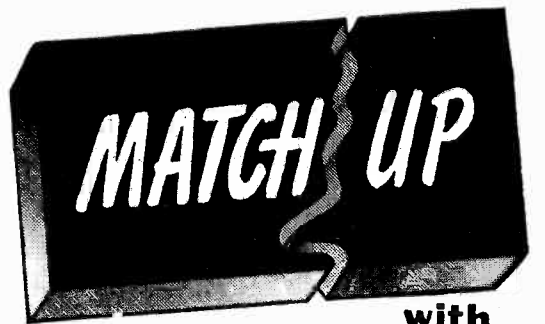
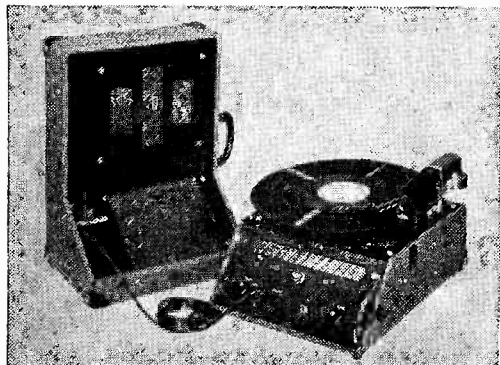

with

TRIPLITT
Meters

5 BASIC MOVEMENTS
IN SIZES FOR EVERY NEED

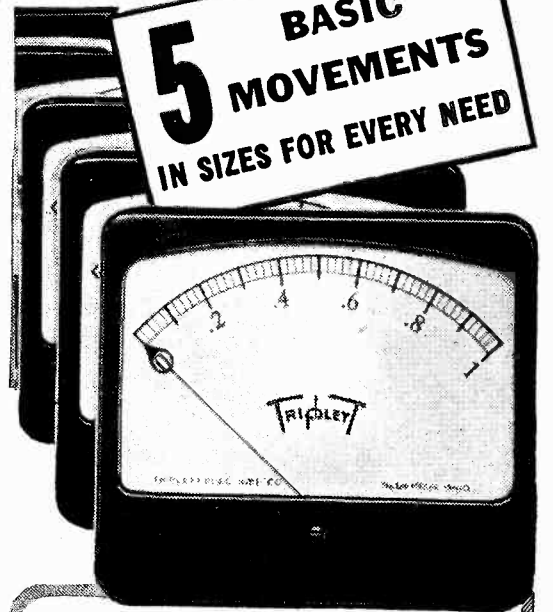

METER HIGHLIGHTS

- **FIVE BASIC MOVEMENTS**—Electrodynamometer, moving iron, moving coil, thermocouple and rectifier types.
- **RANGES**—All standard ranges for every major instrument need.
- **SIZES**—2", 3", 4", 5", 6" and 7".
- **STYLES AND FINISHES**—Round, rectangular, square and fan; wide flange, narrow flange, flush, projection or portable. Available in molded or metal case.
- **SPECIAL FEATURES TO ORDER**—Rear illumination, special dials and other features available on most models.

Triplitt

ELECTRICAL INSTRUMENT CO.
BLUFFTON, OHIO

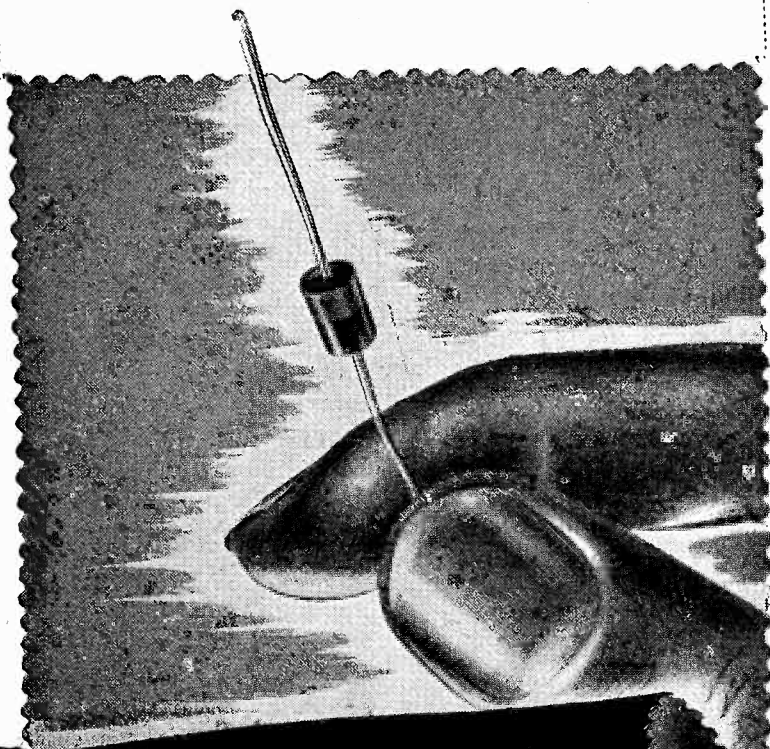

try this for Size!

where Space is a limiting factor

CONSIDER GENERAL ELECTRIC SELENIUM RECTIFIERS

Important savings in space and weight are realized when you design General Electric Selenium Rectifiers into electronic equipment. They'll give you more direct current per cubic inch, more per pound, than alternate types. General Electric offers a wide selection of capacities and sizes, from the mighty midget pictured above which delivers 4 volts at 0.1 milliamperes to single stacks rated at 110 volts, 4 amperes.

Whatever your requirements, General Electric Selenium Rectifiers pack a lot of punch where space is at a premium. They withstand extreme variations in

ambient temperature, humidity, and atmospheric pressure. You can depend upon them for long, faithful service in series, parallel, or series-parallel arrangement.

For a booklet of facts and figures, write direct to Section A-18-431, Appliance and Merchandise Department, General Electric Company, Bridgeport 2, Connecticut.



GENERAL  ELECTRIC

**MILFORD
FASTENING
EQUIPMENT**

MODEL NO. 55DP
**Sets 2 Rivets
At One Time—
120 a Minute**

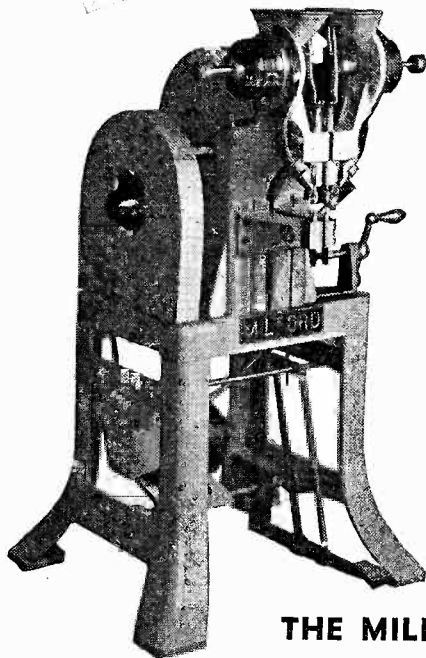

FOR ASSEMBLIES OF

*Cutlery Handles
Small Locks
Name Plates
Radio Chassis
Electrical Parts
Clock Cases • Toys
and a wide variety
of similar products*

Milford manufactures 15 standard rivet setters, designs and manufactures rivets in endless variety. Call Milford for suggestions on assembly operations to cut costs, save time, increase profits.

THE MILFORD RIVET & MACHINE CO.

859 Bridgeport Ave.
MILFORD, CONN.

1002 West River St.
ELYRIA, OHIO

Inquiries may also be addressed to our subsidiary:
THE PENN RIVET & MACHINE CO., PHILADELPHIA 33, PENNA.

**TODAY'S
SCHOOLS...**

must train for TOMORROW
— a challenge intensified by
the accelerating pace of scientific
and engineering advance.

Specially designed to meet the
needs of modern education,
is the NEW...

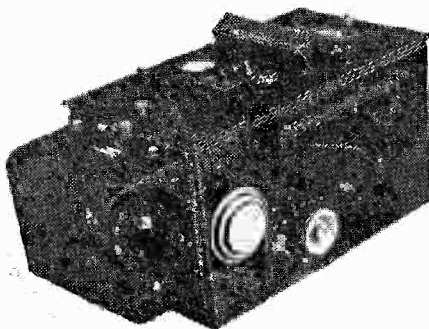

TYPE S-14

STUDENT'S OSCILLOGRAPH

An Essential part of the modern college
laboratory:

- Accuracy, for the critical researcher
- Simplicity, for the undergraduate student
- 6 to 12 channels, precision components

WRITE FOR
TECHNICAL BULLETIN
SP-183A

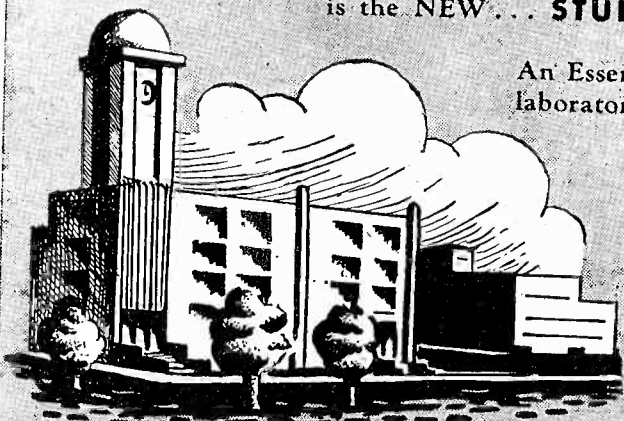

Hathaway
INSTRUMENT COMPANY
1315 SO. CLARKSON STREET • DENVER 10, COLORADO

NEW PRODUCTS

(continued)

no distortion over a wide frequency range. The pickup is mounted on a sturdily built extension bracket maintaining proper alignment at all times. Undistorted power output is 4 watts.

Pyrometric Controller (41)

TACO WEST CORP., 2620 South Park Ave., Chicago, Ill. The new Veritron electronic pyrometric controller is a two position device suited for direct installation on industrial furnaces and plastic moulding machines. In operation, the control pointer is set at the desired temperature and control is immediately established within a narrow temperature range. The design permits the instrument movement to operate a heavy duty relay system without any physical contact or reaction ef-



fect on the indicating pointer. The relay is built in and has a load capacity of 3 kw noninductive. The electronic circuit requires no tuning or other adjustments by the user at any time. A pointer movement upon scale of 0.002 inches produces exacting relay operation. Measuring system and electronic mechanism are separately housed in sealed units that plug into the instrument case, described in Bulletin PC-1.

Five-Inch Scope (42)

THE HICKOK ELECTRICAL INSTRUMENT Co., 10527 Dupont Avenue,

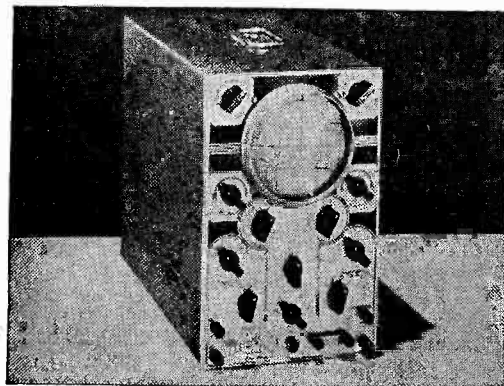

LOW FREQUENCY CELLS
ACTUAL SIZE
ACCURACY TO 1/1,000th of 1%

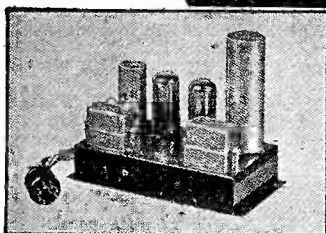

TOP
FREQUENCY STANDARD
(60 cycle) for use with external power supply

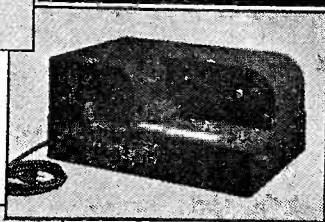

CENTER
CHRONOGRAPH
Records time intervals with resolution to .001 second



BOTTOM
FREQUENCY STANDARD
(120 cycles) with self-contained power supply

These tuning forks which include new engineering principles, provide frequencies from 120 to 1,000 cycles directly with an unqualified guarantee of accuracy to 1 part in 100,000 over a wide temperature range. (Better than 1 second in 24 hours). Closer tolerances are obtainable on special order.

These tuning fork assemblies are available only in single or multi-frequency instruments of our own manufacture which are de-

signed to test, measure or control other precision equipment by mechanical, electrical, acoustical or optical means.

The dependability of these frequency standards is being demonstrated for myriad purposes in all climates and under all working conditions.

If you have need for low frequency standards of exceptional accuracy, your inquiries are invited.

American Time Products, Inc.

580 Fifth Ave.

New York, N. Y.

Dist. of Western Electric &



Watch-rate Recorders



One of the surest ways of sustaining assembly line speed is to standardize on Spintite wrenches. Made to meet the particular problems of radio and electrical assembly and repair, they're designed for precision performance, volume production, durability and ease of operation with a minimum of skill.

Built like a screwdriver, the Spintite shaft readily reaches difficult assembly spots, and it is partly hollowed to permit tightening of nuts through which the bolt protrudes.

Available with either fixed or chuck-type handle, Spintites can be had to fit square, knurled or hex nuts in sizes from 3/16" to 5/8". For the radio and electrical industry's three requisites in tools, speed, accessibility and quantity — specify Spintites.

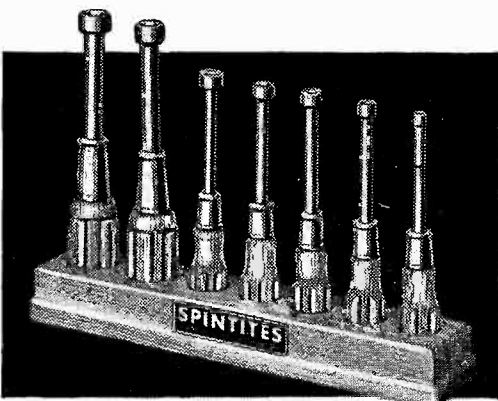

T-73 SET, has 7 sizes of hex heads. Shock-proof handles, and cold forged sockets assure safety and strength. OVER 40 YEARS OF MASTER TOOLMAKING



STEVENS-WALDEN, INC.
Worcester • Massachusetts

NEW PRODUCTS

(continued)

Cleveland 8, Ohio. The Model 195 general-purpose 5-in. oscillograph has a sinusoidal sweep with phasing control. The instrument is designed for visual analysis of the wave shapes of television, f-m, and a-m signals. A type 5 UP-1 cathode-ray tube is used. The unit contains vertical amplifiers allowing a deflection of one inch for each 0.05 volt input.

Discharge Capacitors (43)
SOLAR CORP., 285 Madison Ave., New York 17, N. Y. A new series of type QLX discharge capacitors for pulsed lighting applications, such as speedflash photography, traffic and marine beacons, and airport signals, has just been announced. They

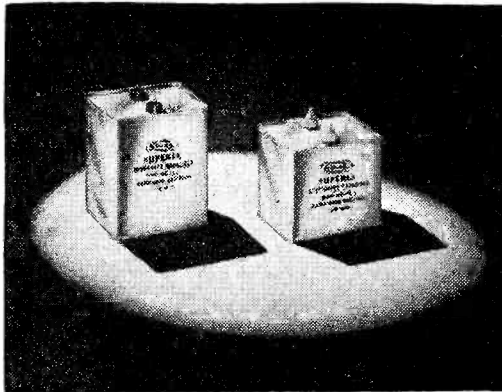

have very heavy internal leads to carry high discharge currents, have a low inherent inductance, and are of special construction to minimize discharge stresses. Complete information as well as a handy watt-second—microfarad—voltage chart is given in Catalog Bulletin SPD-300.

Literature

(44)
Plastic Molders. Kurz-Kasch, Inc., 1415 South Broadway, Dayton 1, Ohio, old-time manufacturers of well-known dials are offering a neat brochure entitled, "A Businessman's Guide to the Molding of Plastics". Besides specifications for various plastic materials, classified according to use, data is given on the company's facilities, equipment and production capacity for molded parts and components.

(45)
Variable Resistors. P. R. Mallory & Co., 3029 E. Washington St., Indianapolis 6, Ind., has announced a new engineering data folder with complete information on carbon and

Here's a few ALDEN PRODUCTS!

All adding time saving in manufacture—convenience of use—saleability—or a reduced overall cost to the product on which they are used.

Read about them

CATHODE RAY SOCKETS



211-214 Series

801-5 PLUGS

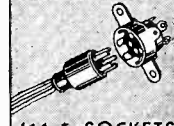

441-5 SOCKETS



MINIATURE CONNECTORS



500 Series



121-5 PLUGS AND 441-5 SOCKETS



AC OUTLET

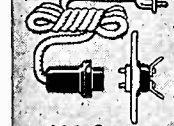

402 AC

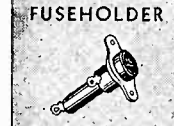

202 Series



FUSEHOLDER



440 FH



TUBE CAP CONNECTORS

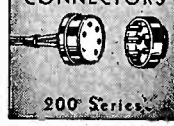

90 Series



TUNING EYES



206-8 Series



DETACHABLE TERMINAL CONNECTORS

200 Series

211 AND 214 SERIES CATHODE RAY TUBE CONNECTOR WITH LEADS

Any requirements in a cathode ray tube connector with proper leads attached engineered as an assembly, high safety factors in all kinds of service. Super-long leakage paths, rounded, "coronaless" clips and individual pocket type insulation and strain relief.

801-5 SHIELDED PLUGS AND 441-5 METAL SOCKETS

Shielded plug and socket for automobile sets or for any other equipment where leads must be shielded and shield grounded to chassis. Shield is easy to put on and solder to plug. Supplied with or without shielded cable.

MINIATURE CABLE CONNECTORS 500 SERIES

Famous for connecting AC motors in combination sets and all kinds of "through-panel" work. Overall diameter only 3/4". Save labor costs by having our special wire equipment put on leads to your particular needs. Underwriters approved.

121-5 MINIATURE PLUGS AND 441-5 SOCKETS

Compact plug and metal seal socket. Use when you want connector to come directly out of chassis. Leads to your specifications. "Pocket" type individual insulation on each lead and clip.

AC OUTLET 402AC

Smallest possible outlet that can be eyeletted or riveted to chassis like other components. Tabs designed for easy soldering.

AC LINE CORDS 202 SERIES

Detachable AC line and with socket, neat and compact. Socket eyelets or rivets in place like other components. Underwriters approved.

FUSEHOLDER 440FH

Here is a fuseholder that rivets or eyelets in place like the other components in your set. Cannot twist or turn, has spring to eject fuse if it breaks, and make contact at base of fuse and prevent rattle. Top contact slotted for easy removal of fuse ferule when glass breaks. Tabs are special design for ease in attaching primary leads of ample size.

90 SERIES TUBE CAP CONNECTORS WITH LEADS

Any requirement in tube cap connectors supplied with leads of proper voltage handling characteristics. Many made special, hundreds of moldings, stampings and wire to draw on.

206-8 TUNING EYES WITH LEADS

Supplied with tailor-made leads. With or without escutcheon and bracket. Individual insulation and strain relief for each lead.

200 SERIES DETACHABLE TERMINAL CONNECTORS

Replaces terminal strips. Supplied with leads. Each lead has individual insulation and strain relief.

WIRE AND CABLE

Any kind of wire or cable laced, braided, woven or assembled with any of our components or those of other make. Many types of wire in stock and in process.

NEW ITEMS

Alden is a specialist in bringing through special electrical assemblies; new samples made promptly.



Radio Components

Facsimile and Impulse Recording Equipment

ALDEN PRODUCTS COMPANY
BROCKTON 64E3, MASS.

THE PROBLEM:

How to simplify modern electronic instruments --- get better control with fewer control units?

THE ANSWER:

THE BECKMAN Helipot

(trademark of the HELlical POTentiometer)

— almost 12 Times* the Resistance Control in Same Panel Space as Conventional Potentiometers!

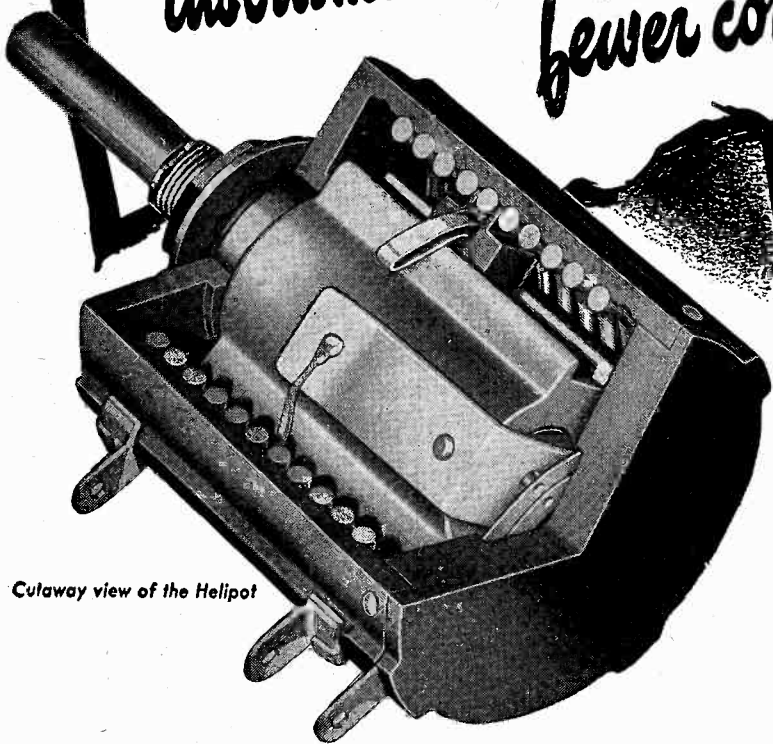

Cutaway view of the Helipot

ON PRODUCT after product the story is the same — the Helipot is revolutionizing potentiometer applications, simplifying control operations, and even making possible advanced electronic instruments impractical with other types of potentiometers. Widely used on precision electronic instruments during the war, the Helipot is an entirely *new* type of potentiometer which every electronic manufacturer and user should investigate.

HIGH LINEARITY—as a result of fulfilling large wartime requirements for ultra-precision circuit controls, Helipots are mass-produced with linearity tolerances of one tenth of one percent—and even less!

PRECISE SETTINGS—Because of the many-times-longer slide wire, settings can be made with an accuracy impossible with single turn units.

WIDE RANGE—By coiling a long potentiometer slide wire into a helix, the Helipot provides many times the range possible with a single turn unit of comparable diameter and panel space.

LOW TORQUE—Of special interest for power-driven applications —the Helipot has unusually low torque characteristics. The 1½" Helipot, for example, is available with a torque of only 1 inch/ounce.

Briefly, here's the Helipot principle . . . whereas a conventional potentiometer consists of a *single* coil of resistance winding approximately 4" long, the Helipot has a potentiometer wire approximately 46"* long coiled *helically* into a case which requires *no more panel space* than the conventional unit. By means of a simple guide, the slider contact follows the helical path of the resistance winding from end to end as a single knob is rotated. Result . . . almost *twelve* times the amount of control — far greater accuracy, finer settings, greater range — *at no increase in panel space requirements!*

Let us study your potentiometer applications and suggest how the Helipot can be used — possibly already is *being* used by others in your industry — to simplify control operations, get greater accuracy and range, and increase the utility of modern electronic equipment. No obligation, of course. Write today outlining your problems.

*HELIPOTS ARE AVAILABLE IN 3 STANDARD SIZES:

TYPE A—5 watts, incorporating 10 helical turns and a slide wire length of 46 inches, case diameter 1¾", is available with resistance values from 25 ohms to 30,000 ohms.

TYPE B—10 watts, with 15 helical turns and 140" slide wire, case diameter 3¼", is available with resistance values from 100 ohms to 100,000 ohms.

TYPE C—2 watts, with 3 helical turns and 13½" slide wire, case diameter 1¾", available in resistances from 5 ohms to 10,000 ohms.

The Type B is also available in special sizes of 25 and 40 helical turns, with resistances ranging from 500 ohms to 300,000 ohms, and containing more than 100,000 change-of-resistance steps.

*Data above are for the standard Type A unit.

Send for the New Helipot Booklet!

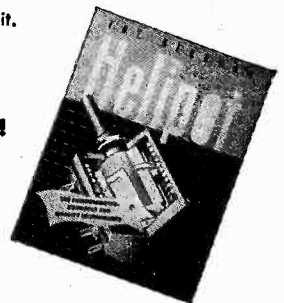

THE HELIPOT CORPORATION, 1011 MISSION STREET, SOUTH PASADENA 2, CALIFORNIA

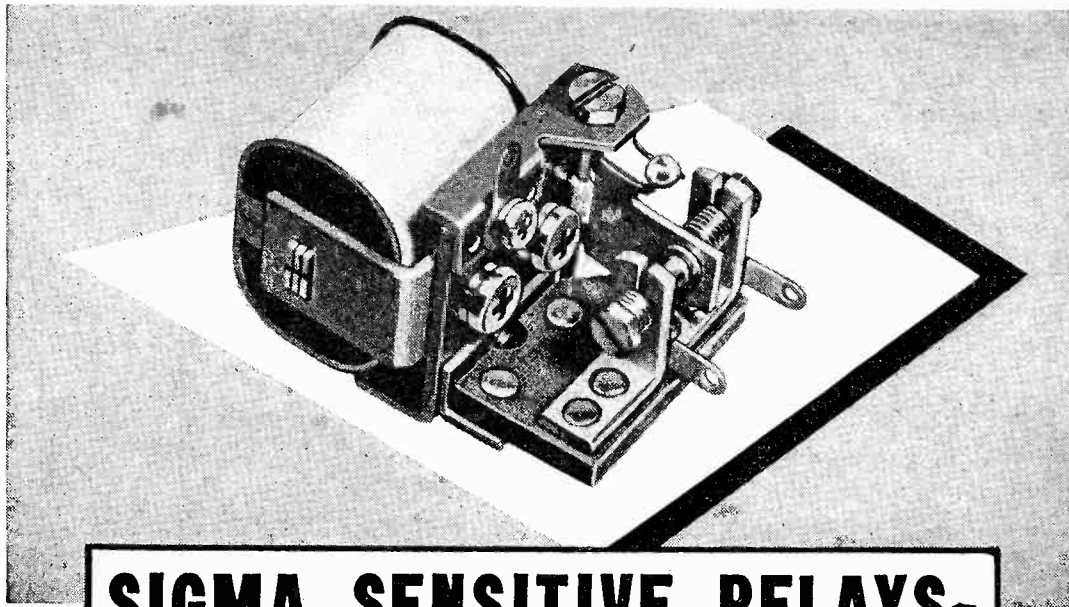

SIGMA SENSITIVE RELAYS-

HAVE PROVEN THEMSELVES IN COUNTLESS APPLICATIONS:

Vehicular Communications Fire and Burglar Alarms High Speed Keying
 Temperature Control Telephone Dialing . . . and many others
 Vacuum Tube Circuits Aircraft Controls



Sigma Instruments, Inc.

Sensitive RELAYS

62 Ceylon St., Boston 21, Mass.

SIGMA'S SPECIALTY is the combination of a fine relay and an unusually thorough approach to your specific application problem.

SIGMA STANDARD RELAYS are available with various enclosures including fixed mountings, 5-pin, and octal male plug bases.

New relays are being developed for special purposes. Send your requirements to SIGMA for dependable relay recommendations.

BURNDY



HYLUGS

BURNDY ... New York 54, N. Y. In Canada: Canadian Line Materials, Ltd., Toronto 13. Foreign: Philips Export Corp., New York 17, N. Y.

NEW PRODUCTS

(continued)

wire wound variable resistors. Taper charts, dimensional drawings, a specification sheet and lots of other things are given.

(46)

WE Tubes. Graybar Electric Co., 420 Lexington Ave., New York 17, N. Y. In tabular form from a new book gives essential data on 166 Western Electric electron tubes. Characteristics, ratings, dimensions and basing diagrams are yours for the asking.

(47)

House Organ. Sorensen & Co., Inc., 375 Fairfield Ave., Stamford, Conn., call their new publication "Currently" and plan to issue bimonthly. Regular features include Transformer Topics and Regulation Hints.

(48)

Reproducer. General Electric Co., Bridgeport, Conn., has issued a catalog bulletin that tells about the new electronic reproducer claimed to banish needle talk, tone arm rumble and make cracked records sound whole.

(49)

Rheostats. Rex Rheostat Co., Baldwin, L. I., N. Y. Catalog 4 lists a series of circular rheostats that can be used in power ranges from 50 to 500 watts. Resistance wire or ribbon is wound on a ceramic core and held in position by a coating of vitreous enamel.

(50)

Insulation Saturants. Bakelite Corp., 300 Madison Ave., New York 17, N. Y., offers a 15-page booklet with no pictures, filled with useful information about Zyrox used in treating fibrous materials for insulating electrical wire and cable. The desirable properties are listed.

(51)

Transmission Lines. Communication Products Co., Inc., Keyport, N. J. supplies pipe-lines for a-m, f-m and television. Having pioneered in this work, their new slick-paper catalog, including pamphlet No. 100, is a convincing presenta-

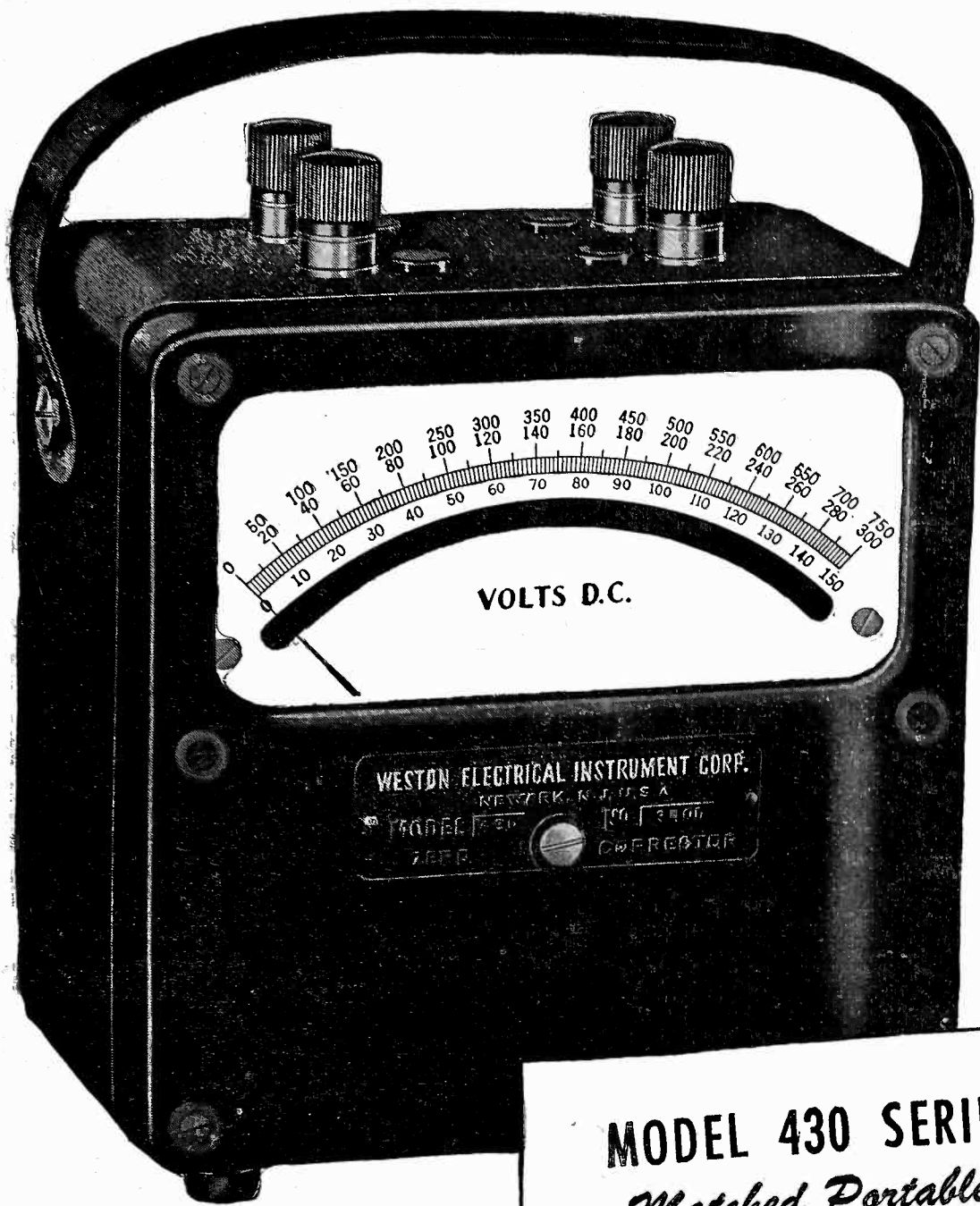

MODEL 430 SERIES
Matched Portables

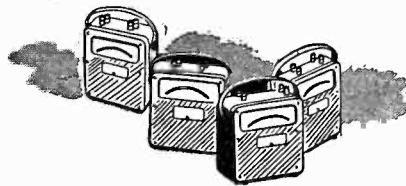

Universal favorites for electrical testing and maintenance . . . compact and extremely rugged, high-visibility mirror scales and knife edge pointers, accuracy and dependability in the WESTON tradition . . . all at relatively low initial cost. Available for all AC and DC requirements. See your nearest WESTON representative or write direct . . . Weston Electrical Instrument Corporation, 618 Frelinghuysen Avenue, Newark 5, New Jersey.

Weston *Instruments*

ALBANY • ATLANTA • BOSTON • BUFFALO • CHARLOTTE • CHICAGO • CINCINNATI • CLEVELAND • DALLAS
DENVER • DETROIT • JACKSONVILLE • KNOXVILLE • LOS ANGELES • MERIDEN • MINNEAPOLIS • NEWARK
NEW ORLEANS • NEW YORK • PHILADELPHIA • PHOENIX • PITTSBURGH • ROCHESTER • SAN FRANCISCO
SEATTLE • ST. LOUIS • SYRACUSE • IN CANADA, NORTHERN ELECTRIC CO., LTD., POWERLITE DEVICES, LTD.

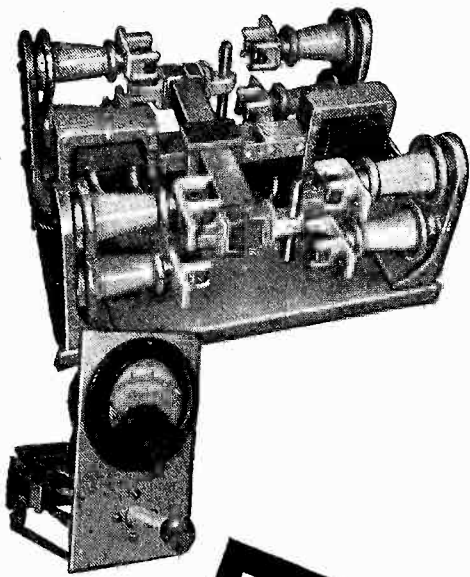

**R. F. CONTACTORS
and
M. B. B. SWITCHES**

JOHNSON R. F. Contactors were designed for switching high voltage, high current, R. F. circuits. Contacts are sectionalized to provide large contact area, and through wiping action, are self cleaning. No holding current is required to operate, and either DPDT or SPDT types are available.

Optional auxiliary switches operate low current control circuits, pilot lights, high current control circuits, or provide sequence operation of contactors.

Electrical Rating	Type JR	Type JS
Solenoid Voltage	230/115V	230/115V
Contacts - Continuous		
Max. R. F. current	50 amps.	30 amps.
Voltage Breakdown	20,000V. peak	14,000V. peak
Dimensions		
Width	9½"	6"
Length	12"	9"
Height	5"	4¼"

With *Make - Before - Break Switches meters may be inserted and removed from antenna or similar high voltage circuits without opening the circuit. They're designed with excellent R. F. insulation for high voltage breakdown and current carrying capacity.

Data Sheets and Prices Available on Request to Dept. DD.

FOR BROADCAST STATIONS
COMPLETE DIRECTIONAL ANTENNA SYSTEMS ★ HIGH VOLTAGE COMPONENTS ★ CO-AXIAL TRANSMISSION LINE ★ F-M ISO-COUPLER ★ OPEN WIRE TRANSMISSION LINE SUPPORTS.

JOHNSON
a famous name in Radio

E. F. Johnson Co. Waseca, Minn.

NEW PRODUCTS

(continued)

tion of Seal-O-Flange and Aircore lines that require no apprenticing as a plumber's helper. The lines just bolt together. The complete line of goods includes air fittings and dryers.

(52)

High Sensitivity Meters. Rawson Electrical Instrument Co., Cambridge 42, Mass., has just turned out Bulletin 501 to show how the line of d-c laboratory meters is constructed and what they do. It is a handy thing to have in your files if you use fine meters.

(53)

Flexible Shafting. Walker-Turner Co., Inc., Plainfield, N. J. Flexible shafting design and engineering data are given in a new 20-page bulletin just released. Covering applications in radio, instruments, and the field of industrial machinery, the new bulletin includes engineering formulas and tables to aid in selection of proper shafting for the job.

(54)

Ceramics in Radio. D. M. Steward Mfg. Co., Chattanooga, Tenn., has just put out a booklet describing Lavite, Steatite and technical ceramics that traces the electrical use of these products from 1880 down to the highly specialized components of today.

(55)

Sound Advances. Sound Apparatus Co., 233 Broadway, New York 7, N. Y., announces a new issue of their technical bulletin "Sound Advances" dealing with a new graphic recorder, the twin recorder, and a new regulated power supply.

(56)

Q Indicator. Freed Transformer Co., Inc., 72 Spring St., New York 12, N. Y., has assembled data on its low frequency Q meter on two pages with the meter itself as cover adornment. This catalog sheet tells details and is worth writing for.

(57)

Silver Brazing. American Platinum Works, 231 New Jersey R. R. Ave., Newark 5, N. J., supplies necessary

Soundcraft and RECORDING LACQUER

The secret of a better recording disc is the lacquer with which it is coated. Recording lacquer is just one of over 2000 lacquer types compounded for various industrial purposes.

Every disc manufacturer uses a slightly different recording lacquer. Most manufacturers comprise consumer appeal, the limitations of coating machinery, and price.

Soundcraft comprises nothing. Soundcraft knows high-fidelity recording requirements. Soundcraft coating methods impose no limitations. Soundcraft's premium price buys the best in raw materials.

Soundcraft discs mean uncompromising lacquer for superior sound recording.

The 'Broadcaster'
8" 10" 12" 16"
The 'Playback'
6½" 8" 10" 12" 16"
The 'Audition'
6½" 8" 10" 12" 16"
The 'Maestro'
12" 13¼" 17¼"



**REEVES
SOUNDCRAFT CORP.**

10 EAST 52 ST., NEW YORK 22, N. Y.
PROGRESS ALONG SOUND LINES

lightweight • compact • built-in power-unit

Standard aircraft RADIO

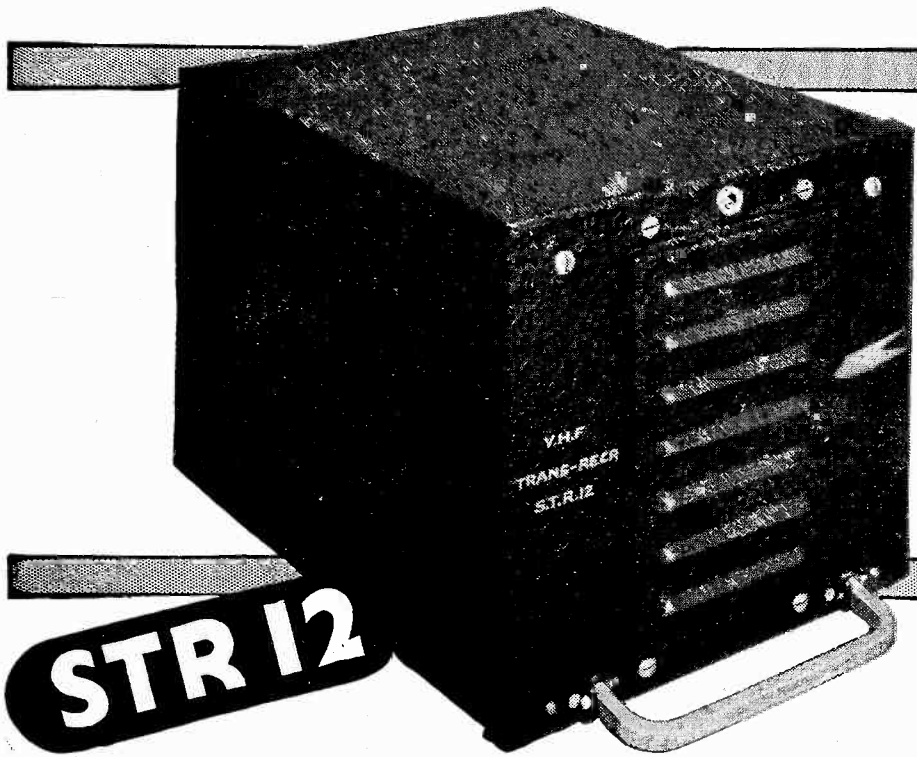

V.H.F. TRANSMITTER
—RECEIVER

Employing

MINIATURE COMPONENTS

and

**MINIATURE
TECHNIQUE**

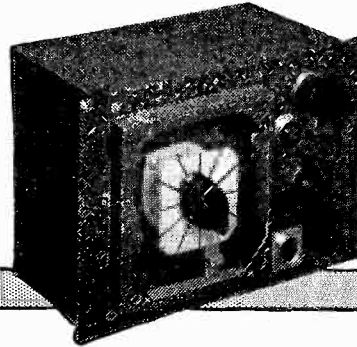

STR 12

12 spot frequencies

A lightweight, high performance transmitter/receiver with twelve 'switch - and - talk' channels.

WEIGHT : 20 lb.

TOTAL INPUT : Transmit-165 W }
 Receive - 123 W } at 26.5V.

FREQUENCIES : 12 Spot frequencies (12 send —12 receive), remotely selected in the band 118-132 Mc/s.

SERVICE : Telephony & M.C.W.

Standard Telephones and Cables Limited • TELECOMMUNICATION
ENGINEERS • OAKLEIGH ROAD • NEW SOUTHGATE • **LONDON**

FIBRE BAER

FABRICATIONS

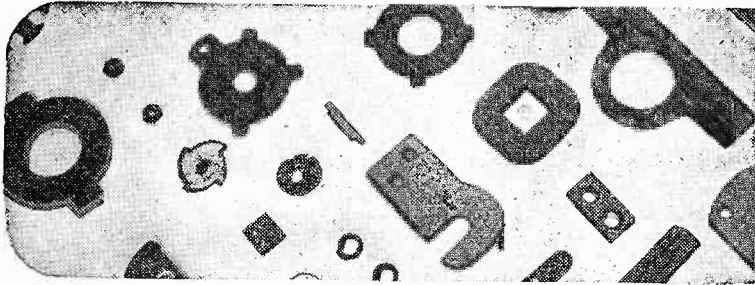

Precision
parts to
your prints

of phenol and
vulcanized
fibre—

**PUNCHED
STAMPED
SHAVED
SAWED
DRILLED
MILLED
TAPPED
THREADED**

Rapid, quality production of phenol fibre and vulcanized fibre parts—either simple components or intricate shapes to close tolerances—can be supplied to your exact specifications. For details, write for descriptive Bulletin 120

N. S. BAER COMPANY

Craftsmen in Fibre Fabrication

7-11 MONTGOMERY ST. • HILLSIDE N. J.

ELECTRIC SOLDERING IRONS

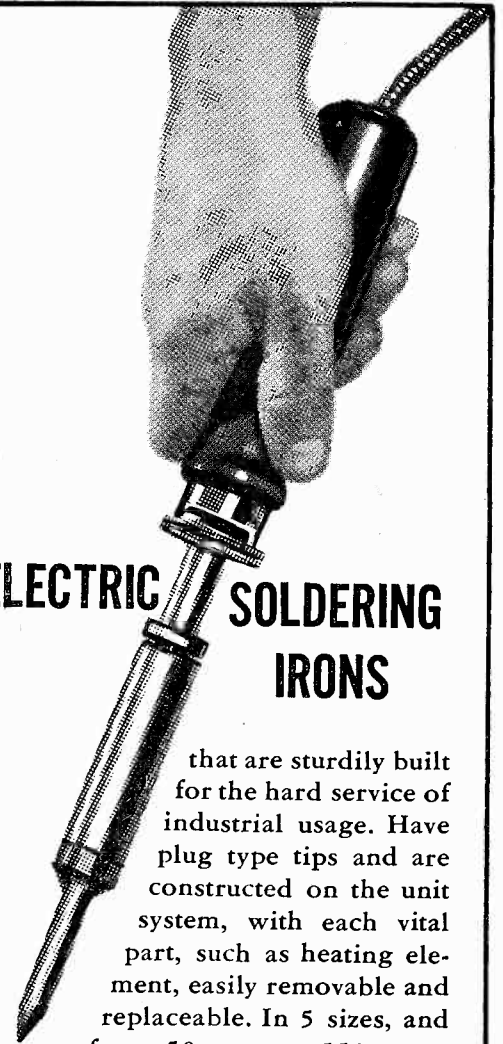

that are sturdily built for the hard service of industrial usage. Have plug type tips and are constructed on the unit system, with each vital part, such as heating element, easily removable and replaceable. In 5 sizes, and from 50 watts to 550 watts.

American Beauty

TEMPERATURE REGULATING STAND

This is a thermostatically controlled device for the regulation of the temperature of an electric soldering iron. When placed on and connected to this stand, iron may be maintained at working temperature, or through an adjustment on bottom of stand, at low or warm temperature.

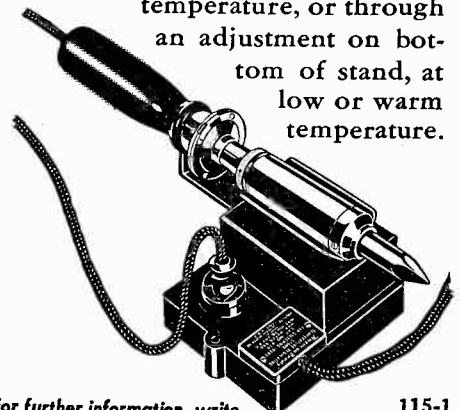

For further information, write

115-1

**AMERICAN ELECTRICAL
HEATER COMPANY**
DETROIT 2, MICHIGAN
established 1894

Symbol of Quality

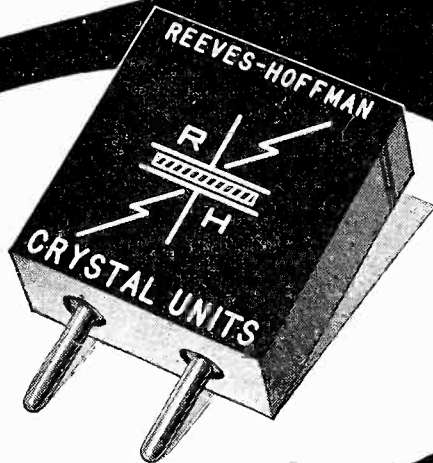

Write for
Crystal Units
Catalog RHC-1

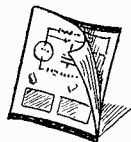

**REEVES-HOFFMAN
CORPORATION**

SALES OFFICE: 215 EAST 91 STREET, NEW YORK 28, N. Y.
PLANT: 321 CHERRY STREET, CARLISLE, PA.

silver solder and fluxes for the new electronic world of hermetically sealed components and microwave plumbing, to mention a couple of the problems. A four-page, two-color brochure lists the materials available, classified as to size and shape.

(58)

Wire Stripper. Lead-All Products Co., 24 East 21st St., New York 10, N. Y., manufactures hand and foot operated wire stripping machines as well as motor driven screwdrivers and other production devices. Bulletin No. 16 devotes four pages to text and illustrations that will give you a clear picture of this company's products.

Tube Registry

The information furnished by the RMA Data Bureau has been abridged and only the more significant dimensions are given.

Type 6BL6

Velocity modulation reflex oscillator—external cavity, heater type, 4 pin base, disc seal glass envelope, maximum operating frequency 2 3/4 mode 4,800 mc.

$E_A = 6.3$ v
 $I_h = 0.65$ amp
 $E_{c1} = 0.0$ v
 $E_{c2} = E_{c3} = 325$ v
 $I_k = 25$ ma
 Repeller (at $f = 2,140$ mc, 2 3/4 mode) = -40 v

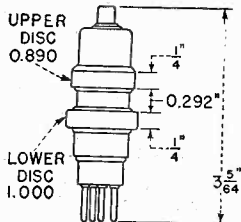

This information represents a correction and revision of data given on this tube in the Feb. 1947 issue of ELECTRONICS.

Type 12AU7

Twin - triode voltage amplifier, heater type, T6 1/2 integral glass en-

$E_f = 6.3/12.6$ v
 $I_f = 0.3/0.15$ amp
 $E_b = 300$ v (max)
 $W_p = 2.75$ watts
 $I_k = 20$ ma
 $E_b = 250$ v
 $I_b = 10.5$ ma
 $E_c = -8.5$ v
 $\mu = 17$
 $\mu_m = 2,200$ μ mhos
 $r_p = 7,700$
 $C_{in} = 1.6$ μ mf
 $C_{out} = 0.50/0.35$ μ mf
 $C_p = 1.5$ μ mf
 Basing 9A

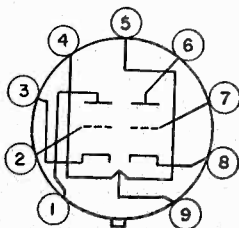

New! CONCORD'S

LATEST CATALOG OF

RADIO PARTS

AND ELECTRONIC EQUIPMENT

CONCORD'S
Outstanding 1947
RADIO VALUES

RADIO
 PARTS • SETS
 TESTERS

SPECIAL VALUES
 HAM GEAR
 AMPLIFIERS

FREE!
 MAIL COUPON
 BELOW!

CONCORD RADIO
 CORPORATION
 CHICAGO 7, ILL. ATLANTA 3, GA.
901 W. JACKSON BLVD. 265 PEACHTREE STREET

RECORD
 CHANGERS
 PLAYERS

Thousands of Newest Items! Immediate Shipment!

Largest stocks of all leading lines of nationally-known Radio Parts and Electronic Equipment on hand at all times at lowest prices for the amateur and professional radio man.

Just off the press—48 exciting pages of radio parts, equipment, and supplies for dealers, servicemen, amateurs, maintenance, testing, building and experimenting—Thousands of items NOW IN STOCK and ready for IMMEDIATE SHIPMENT! Big feature sections of Radio Sets, Communications Receivers, Amplifiers, Replacement Parts, Ham Gear, Record Players and Portables, Record Changers and complete Sound Systems. Page after page of bargains in top-quality standard-make radio parts and electronic equipment.

Mail Coupon NOW for FREE COPY

Mail coupon below TODAY for your FREE COPY of this latest Concord Buying Guide and Bargain Catalog of Radio needs you can order for SAME DAY SHIPMENT from complete stocks in Chicago and Atlanta.

CONCORD

RADIO CORPORATION
LAFAYETTE RADIO CORPORATION
CHICAGO 7, ILL. ATLANTA 3, GA.
901 W. Jackson Blvd. 265 Peachtree St.

CONCORD RADIO CORP., Dept. G-47
901 W. Jackson Blvd., Chicago 7, Ill.
Yes, rush FREE COPY of the new
Concord Bargain Catalog.

Name.....

Address..... State.....

City.....

GRACOIL

"One Good Turn - or a Million"



★ Here, in expanded plant facilities, GRACOIL Coils and Transformers are expertly designed and built to exact specifications. Plan your next product with GRACOILS.

THE GRAMER COMPANY

Established in 1935

Electrical Coils and Transformers

2736 N. PULASKI RD.,

CHICAGO 39, ILL.

U. S. A.

ZOPHAR

Waxes, Compounds and Emulsions



Materials for potting, dipping or impregnating all types of radio components or all kinds of electrical units. • Tropicalized fungus proofing waxes. • Waterproofing finishes for wire jackets. • Rubber finishes. • Inquiries and problems invited by our engineering and development laboratories.

Zophar Mills, Inc. has been known for its dependable service and uniformity of product since 1846.

ZOPHAR MILLS, Inc.

ESTABLISHED 1846

117 26th STREET, BROOKLYN, 32 N. Y.

At last—

THE RADAR ENGINEER'S HANDBOOK

—presenting up-to-date data on theory and

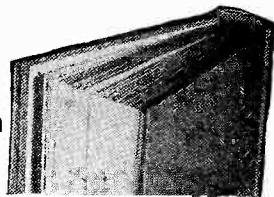

practices of radar technology

—telling how to design equipment

—describing typical radar systems

Here is a comprehensive, handy reference guide to the practical and engineering aspects of radar. It is specifically designed to acquaint engineers and technical workers in radio and electronics with new techniques, and with special applications of old techniques used in radio detecting and ranging of objects. Completely covering radar theory and practice, this handbook gives you the fundamentals essential to understanding the practical and effective employment of radar apparatus, describes various radar systems developed and used during the war, and explains in technical detail the design of specific radar equipment.

Just Out

RADAR ENGINEERING

By DONALD G. FINK

Executive Editor, *Electronics*; Formerly Staff Member, Radiation Laboratory, M.I.T.; and Expert Consultant, Office of the Secretary of War

644 pages. 471 figures. 6x9. \$7.00

This is the first complete book on radar—bringing together in convenient form, full, authoritative data on the many individual developments to date in this field. It enables the engineer to understand quickly and easily the underlying theory of all branches of radar, and to judge critically the use of that theory in the design of radar equipment. It supplies many design formulas which may be applied not only in the fields of radar but in related fields of ultra-high-frequency and super-high-frequency communication, in navigation aids, etc.

A partial list of the contents indicating the wide scope of radar theory and practice covered in this handbook.

- Introduction to Radar Concepts
- Radio Frequency Fundamentals
- Transmission Lines
- Waveguides
- Resonant Cavities
- Radiators and Reflectors
- Propagation and Targets
- Introduction to Radar Design
- Basic Radio-frequency Circuits and Structures
- Transmitters and Radiators
- Receivers
- Indicators & Scanners

Theoretical material includes data on pulse generation and transmission, waveguides, reflection of radio energy, etc. Practical aspects covered deal with components, circuits, and structures used in radar equipment. The various types of equipment described are those employing wide range frequencies of 200, 600, 3,000, and 10,000 megacycles.

See it 10 days FREE

MAIL THIS COUPON

McGraw-Hill Book Co., 330 W. 42 St., NYC 18

Send me Fink's Radar Engineering for 10 days' examination on approval. In 10 days I will send \$7.00, plus few cents postage, or return book postpaid. (Postage paid on cash orders.)

Name

Address

City and State.....

Company

PositionL-4-47

(For Canadian price, write: Embassy Book Co., 12 Richmond Street E., Toronto, 1)

velope-base; overall height $2\frac{3}{8}$ in.; diameter, $\frac{3}{8}$ in.; small button noval 9-pin base.

Type 9C24

Triode power amplifier-oscillator, filament type; metal-glass construc-

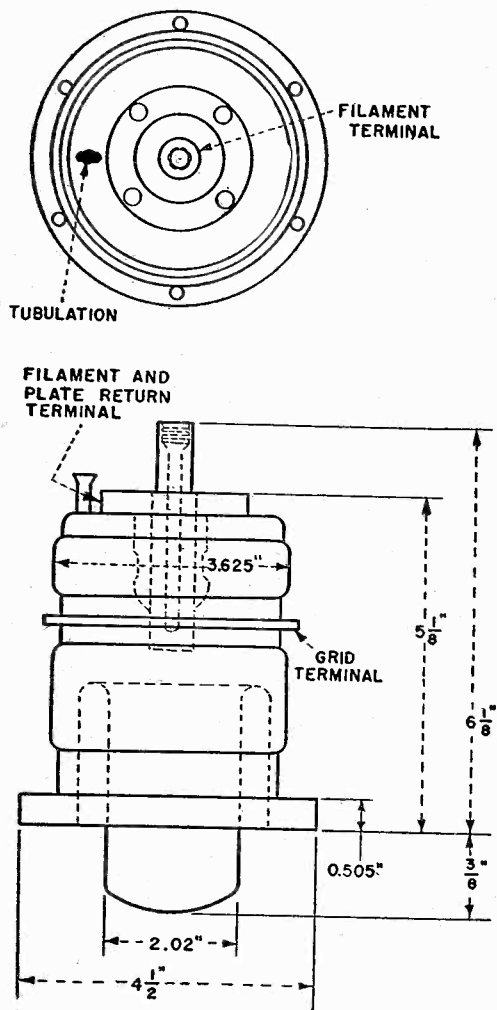

- | | |
|---------------------------|------------------------|
| $E_f = 6.3$ to 6.6 v | $g_m = 11$ millimhos |
| $I_f = 230$ to 250 amp | $E_b = 6,500$ v (max) |
| $C_{in} = 24 \mu\mu f$ | $I_b = 2.0$ amp (max) |
| $C_{out} = 0.47 \mu\mu f$ | $E_c = -850$ v (max) |
| $C_p = 15.7 \mu\mu f$ | $I_c = 0.25$ amp (max) |
| $I_b = 1.0$ amp | $W_p = 5$ kw (max) |
| $E_c = -50$ v | |
| $\mu = 21$ | |

tion; concentric plate, grid, filament terminals. Class-C amplifier.

Type 7C30

Triode power amplifier-oscillator,

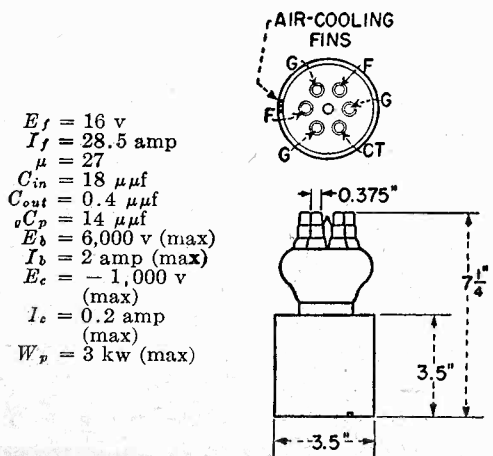

- | |
|--------------------------|
| $E_f = 16$ v |
| $I_f = 28.5$ amp |
| $\mu = 27$ |
| $C_{in} = 18 \mu\mu f$ |
| $C_{out} = 0.4 \mu\mu f$ |
| $C_p = 14 \mu\mu f$ |
| $E_b = 6,000$ v (max) |
| $I_b = 2$ amp (max) |
| $E_c = -1,000$ v (max) |
| $I_c = 0.2$ amp (max) |
| $W_p = 3$ kw (max) |

THREE-DIMENSIONAL RECORDING WITH THE NEW TWIN RECORDER

Simultaneous Recording of TWO VARIABLES as the result of a THIRD VARIABLE

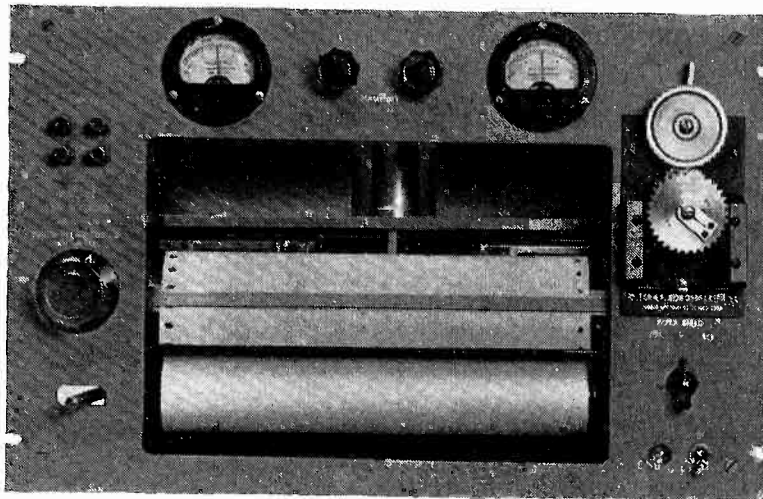

Suggesting a few of the applications . . . PROVED in our laboratories . . . IN USE by our customers:

- | | |
|-------------------------------|--|
| | CHANNEL |
| ● SOUND | A. Loudness in Phons
B. Sound intensity in DB |
| ● VIBRATION | A. Noise in DB or Phons
B. Mechanical vibration in displacement, velocity or acceleration |
| ● NETWORKS | A. Reactance
B. Resistance |
| ● TRANSDUCERS | *A. Microphone Response in DB
*B. Loudspeaker Response in DB
*Absolute measurements, using a "Sound Pressure Standard" |
| ● VACUUM TUBES | A. Plate Current
B. Grid-Plate Voltage |
| ● EXPANDED SCALES | A. ex. 20 DB Range
B. ex. 80 DB Range |
| ● DUPLICATE RECORDS | A. Actual Measurement
B. Duplicate of Channel A |

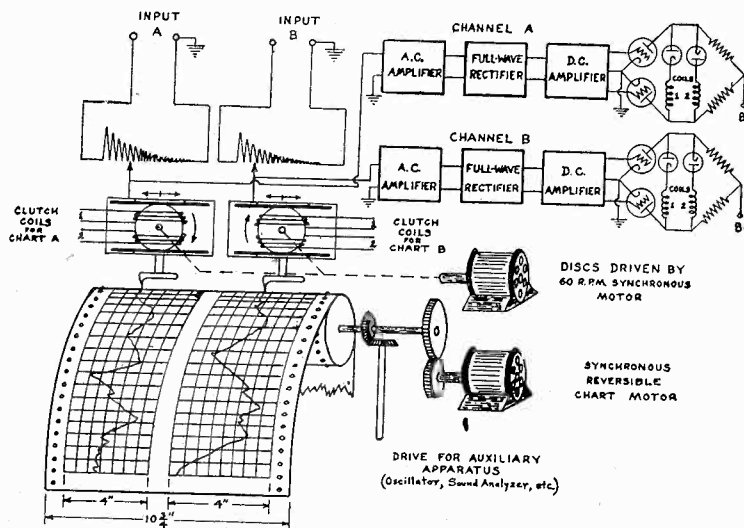

Functional Diagram of the TWIN-RECORDER

Information on this versatile instrument will be sent upon request. Inquiries concerning eventual modifications will receive prompt attention.

SOUND APPARATUS CO.
233 BROADWAY • NEW YORK 7, N. Y.

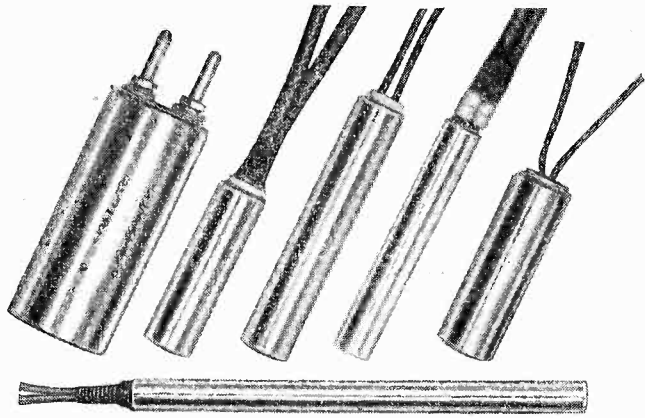

VULCAN CARTRIDGE TYPE HEATERS

Practically every kind, type and size.

MANY TYPES IN STOCK.

If you have a problem involving Electric Heating Units—Cartridge, Flat, Immersion, Tubular or Special,—write us. We like problems.

VULCAN ELECTRIC COMPANY

DANVERS, 10, MASS.

Makers of a wide variety of Heating Elements for assembly into manufacturer's own products and of Heating Specialties that use electricity.

PREMAX

For Mobile Units



Premax Police

Antennas

Premax "whip" type Antennas in steel stainless and aluminum . . . the sort that will withstand severe road shocks.

Mountings are available in many styles to meet all installation conditions.

Ask your radio jobber for new Premax Catalog, showing the complete line.

Premax Products

Division Chisholm-Ryder Co., Inc.

4711 Highland Ave. Niagara Falls, N. Y.

eight years ago

... *PyroFerric* PIONEERED

the manufacture of
**SCREW-TYPE
POWDERED
IRON CORES**

... today PyroFerric is manufacturing a full line of standard sized Powdered Iron Screw-type Cores of varying lengths, with standard threads, as well as its complete line of powdered iron cores, with and without inserts.

For Powdered Iron Cores to meet your specification address your inquiry to

PYROFERRIC Co.

175 VARICK ST. NEW YORK 14, N. Y.

The "daddy" of screw-type powdered iron cores—made 8 years ago.

★ **STAR**

Specialists in Internal and External Perfect Threaded Die Cast Units

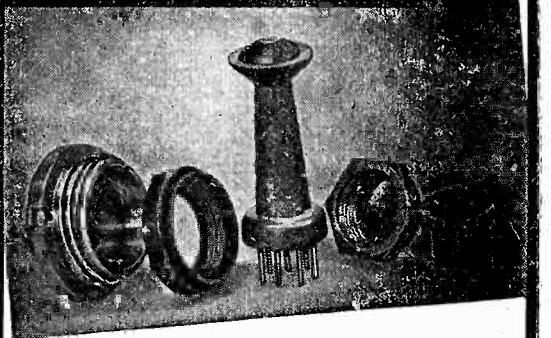

Intricate parts of 100% rust-proof Zinc alloy.

Accurate to specification. Held to tolerances of .005.

Threads require no machining.

Ideal for instrument, small machine and minute electronic parts.

Producers of the Two Vital Aids to Manufacturers of Miniature Tube Radios.

JE-10 STAR MINIATURE SOCKET WIRING PLUGS.

JE-13 STAR MINIATURE TUBE PIN STRAIGHTENERS

Write for complete information

STAR EXPANSION PRODUCTS CO.

(INCORPORATED)

147 Cedar St. New York 6, N. Y.

filament type; maximum ratings up to 1.6 mc.

Type 5530

Triode power amplifier-oscillator, forced air cooled, filament type,

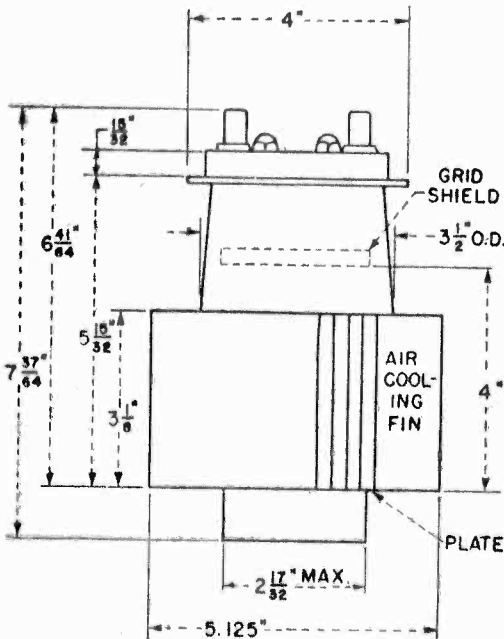
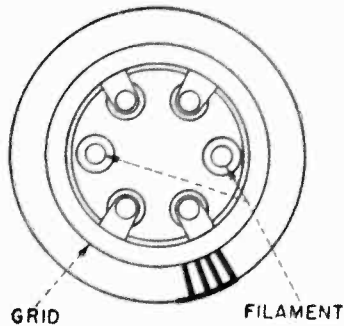

- $E_f = 5 \text{ v}$
- $I_f = 55 \text{ amp}$
- $E_b = 1,300 \text{ v}$
- $I_b = 2.25 \text{ amp}$
- $\mu = 26$
- $g_m = 12,500 \text{ } \mu\text{hos}$
- $C_{in} = 20 \text{ } \mu\text{f}$
- $C_{out} = 0.6 \text{ } \mu\text{f}$
- $C_p = 23 \text{ } \mu\text{f}$
- $E_b = 4,500 \text{ v (max)}$
- $I_b = 2.25 \text{ amp (max)}$
- $W_p = 3 \text{ kw (max)}$

metal-glass envelope. Maximum ratings up to 110 mc.

Type 5560

Tetrode mercury thyratron, heater type; heating time 5 minutes; ioni-

- $E_f = 5 \text{ v}$
- $I_f = 4.5 \text{ amp}$
- $E_{drop} = 16 \text{ v}$
- $C_b = 4.4 \text{ } \mu\text{f}$
- $C_p = 0.2 \text{ } \mu\text{f}$
- $E_{max} = E_{rod} = 1,000 \text{ v (max)}$
- $I_b = 0.5 \text{ amp (peak)}$
- $I_b = 2.5 \text{ amp (average for 15 sec)}$

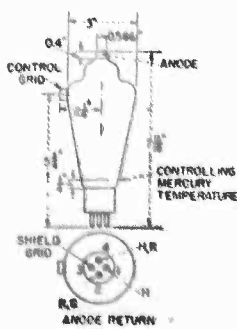

- Control:
- | | | |
|---------|----------|----------|
| E_b | E_{ct} | E_{cd} |
| 1,000 v | 0 v | -9 v |
| 100 v | 0 v | +1 v |

Twenty years devoted exclusively to the problems of radiation measurement

Instruments to measure every phase of radiation



Subminiature electrometer tubes especially designed for circuits used in radiation measurement. Available as diodes, tetrodes, triodes, pentodes.



Hi-megohm resistors values from 100 to 10,000,000 megohms. For finer instrumentation requiring stability and accuracy.



Model 337 Geiger-Mueller Counter. A scaling circuit of top ranking quality with built-in 2000 volt power supply and ingeniously new voltage regulation.

A complete sequence of measuring instruments for industrial research, control and protection covering x-rays, gamma, beta and alpha radiation.

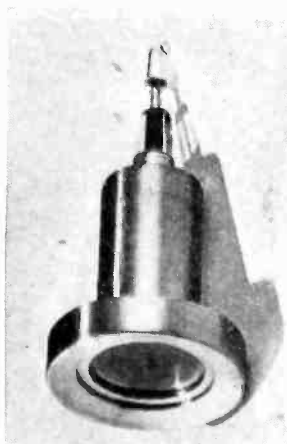

Model 311 — VG series Geiger-Mueller Tubes. Production controlled to close tolerances available in mica window thicknesses from 3.0 to 4.5 mg. per cm².

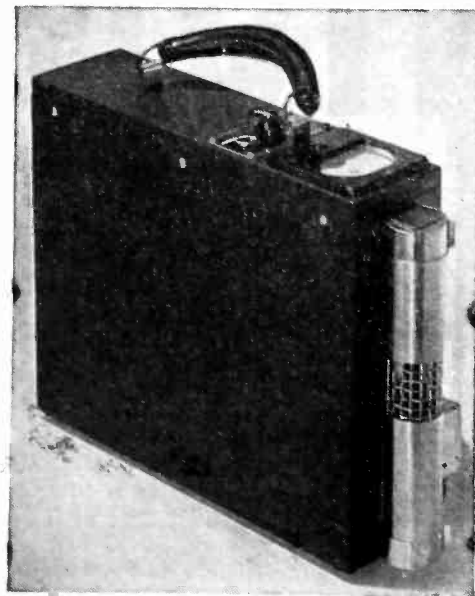

Model 263 Gamma and Beta Counter, portable, compact, unique. Geiger-Mueller tube conveniently mounted in external probe. Roentgen calibrated for gamma radiation. Equipped with ear phones.

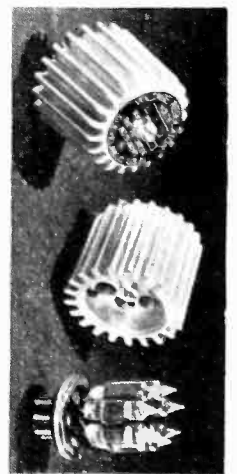

Model 348 voltage regulator unit as used in scaler. Adaptable where voltage regulation requires flat top, accuracy and space conservation.

Write for complete information on any of these instruments or any other problem on radiation measurement. We have instruments designed for every application.

THE VICTOREEN INSTRUMENT CO.
5806 HOUGH AVENUE
CLEVELAND 3, OHIO

4 Oscillograph traces on 70 mm. paper.

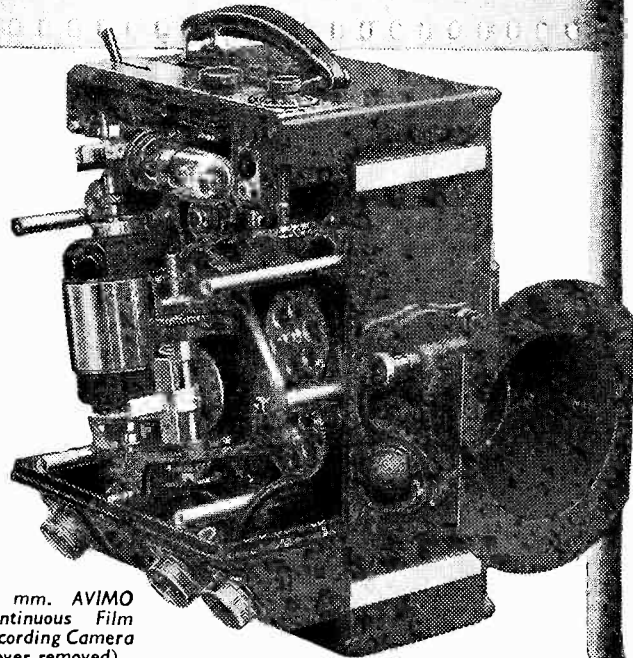

35 mm. AVIMO Continuous Film Recording Camera (cover removed).

9016E

RECORDING TRANSIENT PHENOMENA

The behaviour of moving parts under actual working conditions may be studied by means of standard commercial oscillographs, which translate mechanical or electrical variations into evanescent traces on a fluorescent screen. Avimo cameras record these traces on continuous film or paper, so that they may be subsequently checked, examined, and measured. Write for Publication C3, giving full details of AVIMO Cameras including types with built-in cathode ray tubes.



AVIMO Ltd., TAUNTON
(Eng.) Tel. 3634

Designers and Manufacturers of
Scientific Cameras



Alexander Graham Bell
achieved fame
before our time,
but since 1920,
we have answered
local and long distance calls
for help, parts and
all types of radio and
electronic equipment
for customers from all
sections of the country.

Lafayette

RADIO WIRE TELEVISION, INC.
**FOR RADIO & ELECTRONIC
EQUIPMENT**

100 SIXTH AVE., NEW YORK 13
110 FEDERAL ST., BOSTON 10
24 CENTRAL AVE., NEWARK 2

QUALITY and PRODUCTION

DINION

*Transformers
and Coils*

- Television
- Radio
- Photo Flash Control
- Instrument
- Electronic and Industrial Applications
- Electrical Coil Windings



Specialists in
Difficult Designs

DINION COIL COMPANY, Inc.

CALEDONIA, N. Y.

**THERE'S A DRAKE
SOLDERING IRON
FOR EVERY TYPE OF
ELECTRONIC WORK**

From that mighty mite



the Drake No. 400 to the high-speed production "honey"



the Drake No. 600-10 there is a high quality Drake Soldering Iron "just right" for the job.

Drake Heat Controls and the Drake "Magic Cup" Stand are important soldering aids.



SEE
**YOUR RADIO
PARTS JOBBER**

DRAKE ELECTRIC WORKS, INC.
3656 LINCOLN AVE. CHICAGO, ILL.

zation time 10 microseconds; deionization time 1 millisecond. Maximum ratings up to 150 cps; mercury temperature 40 to 80 C.

Type 672A

Tetrode mercury thyratron, heater type; heating time 5 minutes; ionization time 10 microseconds; deion-

- $E_f = 5$ v
- $I_f = 5$ amp
- $E_{drop} = 12$ v
- $C_{p1} = 0.04 \mu\text{mf}$
- $C_{p2} = 3 \mu\text{mf}$
- $E_p = 2,500$ v (peak forward or reverse)
- $I_p = 3.2$ amp (average)
- $I_p = 40$ amp (peak)
- $E_o = 1,000$ v (peak negative before conduction)
- $E_{so} = 300$ v. (peak negative before conduction)

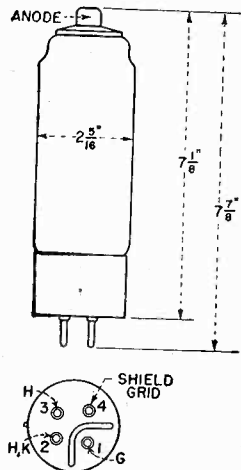

ization time 1 millisecond; temperature range (condensed mercury) 40 to 80 C. Maximum ratings up to 150 cps.

Type 5541

Triode power amplifier-oscillator, forced air cooled, filament type. Maximum ratings up to 110 mc.

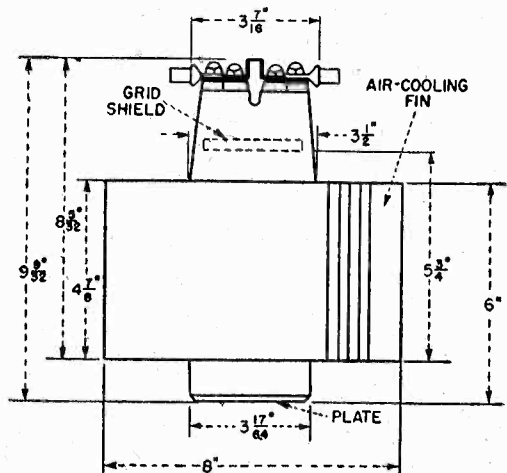
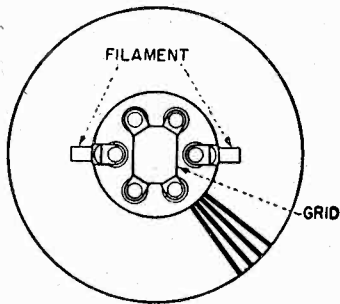

- $E_f = 7.5$ v
- $I_f = 55$ amp
- $E_b = 3,100$ v
- $I_b = 3.25$ amp
- $\mu = 26$
- $g_m = 20,700 \mu\text{mhos}$
- $C_{in} = 21.0 \mu\text{mf}$
- $C_{out} = 1.5 \mu\text{mf}$
- $C_p = 25 \mu\text{mf}$
- $E_p = 8,500$ v (max)
- $I_p = 3.25$ amp (max)
- $W_p = 10$ kw (max)

Electronic Regulated POWER SUPPLIES



PRECISION ACCURACY PERFORMANCE

Built to rigid U. S. Government Specifications

SPECIFICATIONS

INPUT—115 v. 50-60 cycle

REGULATIONS—Less than 1/20 volt change in output voltage with change of from 100-140 V.A.C. input voltage & from NO-LOAD to FULL-LOAD (over very wide latitude at center of variable range)

RIPPLE—Less than 5 millivolts at all loads and voltages

DIMENSIONS—Fits any standard rack or cabinet (overall: 19 in. wide; 12 1/4 in. high; 11 in. deep; shipping wt.—100 pounds)

TYPE A—VARIABLE FROM 210 TO 335 V. D. C. @ 400 M. A.

TYPE B1—VARIABLE—TWO RANGES: 400-600 V. D. C. @ 125 M. A. and 600-890 V. D. C. @ 125 M. A.

CONSTRUCTION FEATURES

Weston model 301 (or equal) millimeter and voltmeter • Separate switches, pilot lights, and fuses for FIL and PLATE VOLTS • All tubes located on shockmount assemblies • Fuses mounted on front panel and easily accessible • Can vary voltage by turning small knob on front of panel. Can easily modify Type B1 from POSITIVE to NEGATIVE output voltage • Individual components numbered to correspond with wiring diagram.

Rigid construction: components designed to withstand most severe military conditions—physical and electrical; were greatly under-rated.

All units checked and inspected at 150% rated load before shipment.

Tube complement: { Type A: 2-836; 6-6L6; 2-6SF5; 1-VR150; 1-VR105
Type B1: 2-836; 2-6L6; 2-6SF5; 1-VR150; 1-VR105

IMMEDIATE DELIVERY

NET PRICES—F. O. B. BALTIMORE, MD.

TYPE A—\$189.00

TYPE B1—\$185.00

Complete with tubes and ready to plug in—Prices subject to change without notice

NATIONAL RADIO SERVICE CO.

Reisterstown Rd. & Cold Spring Lane

Baltimore 15, Md.

New

STREAMLINED

SHIELDS FOR T-5 1/2 MINIATURE BULBS

SLIDE FIT FLUTES ELIMINATE
SOCKET CONTACT TROUBLES
CAUSED BY VIBRATION

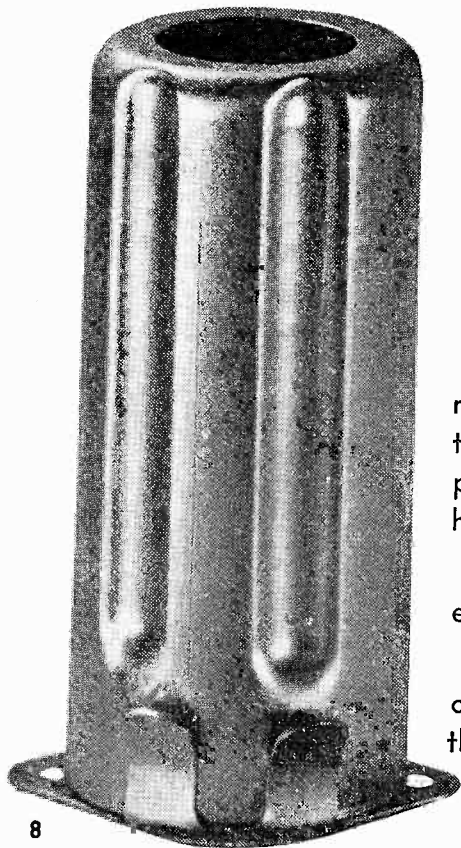

The shield is sized so that three of the flutes make a slide fit with the tube, supporting it throughout its length. A hardened and tempered spring steel clip locates the shield and holds the tube firmly in place.

These modern, streamlined shields combine eye appeal with low cost, effective shielding.

Due to the direct contact between the flutes of the shield and the glass surface of the bulb, the Goat G-1700 shield dissipates heat rapidly.

8



METAL STAMPINGS, DIVISION OF
THE FRED GOAT CO., INC. 314 Dean Street, Brooklyn 17, New York

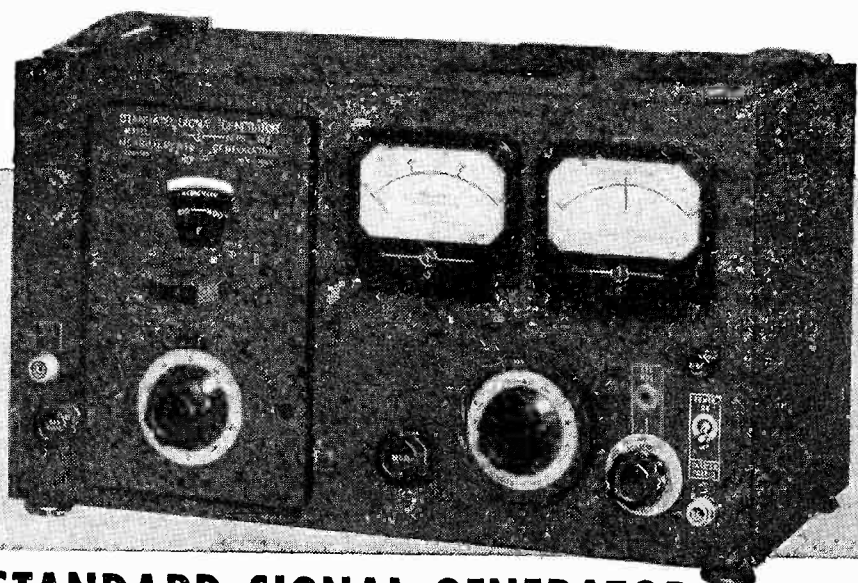

STANDARD SIGNAL GENERATOR Model 80

CARRIER FREQUENCY RANGE: 2 to 400 megacycles.

OUTPUT: 0.1 to 100,000 microvolts.
50 ohms output impedance.

MODULATION: A M 0 to 30% at 400 or 1000 cycles internal.

Jack for external audio modulation.

Video modulation jack for connection of external pulse generator.

POWER SUPPLY: 117 volts, 50-60 cycles.

DIMENSIONS: Width 19", Height 10 3/4", Depth 9 1/2".

WEIGHT: Approximately 35 lbs.

Suitable connection cables and matching pads can be supplied on order.

MANUFACTURERS OF
Standard Signal Generators
Pulse Generators
FM Signal Generators
Square Wave Generators
Vacuum Tube Voltmeters
UHF Radio Noise & Field
Strength Meters
Capacity Bridges
Megohm Meters
Phase Sequence Indicators
Television and FM Test
Equipment

MEASUREMENTS CORPORATION
BOONTON NEW JERSEY



NEWS OF THE INDUSTRY

(continued from p 162)

ferred by the Massachusetts Institute of Technology for study and research in the field of electronics.

Applicants for graduate fellowships having \$1,200 to \$1,500 stipends must satisfy the requirements for admission to the Graduate School. Recipients of such fellowships will pursue programs of study and research leading towards advanced academic degrees in physics or electrical engineering. It is expected that the area of specialization of a fellow will fall within the field of electronics.

A few advanced research fellowships carrying stipends of \$2,000 to \$3,000 will be awarded to candidates possessing graduate academic degrees or equivalent research experience. In most cases these will be post-doctorate fellowships. They are open also to candidates with the requisite experience on leave from industrial or other research laboratories.

Applicants for an Industrial Fellowship in Electronics should communicate with J. A. Stratton, Director, Research Laboratory of Electronics, Massachusetts Institute of Technology, Cambridge, Mass. Under normal circumstances application must be made at least four months prior to the intended date of entrance.

New England IRE Meeting

AN ALL-DAY radio engineering meeting will be held at the Hotel Continental in Cambridge, Mass. on Saturday May 17, under sponsorship of the newly created North Atlantic Region of the IRE. New England manufacturers of radio and electronic products will present exhibits. Social events scheduled include a luncheon and banquet. Chairman is L. E. Packard, Technology Instruments Corp., Waltham, Mass. The six technical papers scheduled for presentation, none concurrently, are:

Low-Drag Aircraft Antennas for Frequencies from 2 to 18 Mc—John V. N. Granger, student, Harvard University.

The Commercial Design of Geiger-Muller Counter Tubes—Herbert Metten of Sylvania Electric Products, Inc.

Recent Developments in Frequency Stabilization of Microwave Oscillators—William G. Tuller of MIT.

VHF Bridge for Impedance Measurements

Doubly So Today "BE WISE— KENYONIZE"

Years ago our customers heartily agreed with this "Be Wise — Kenyonize" idea. They know how much time, trouble—and money — our reliable transformers saved them.

Today they agree — doubly so; Kenyon ends all concern over the performance of new or substitute materials. They know, with Kenyon, quality comes first!

THE MARK OF  EXCELLENCE

KENYON
TRANSFORMER CO., Inc.
840 BARRY ST., NEW YORK, N. Y.

CONVERT ★ YOUR SWITCH DESIGN TO ACRO Snap-Action

Small
Compact
Two Pole
Design

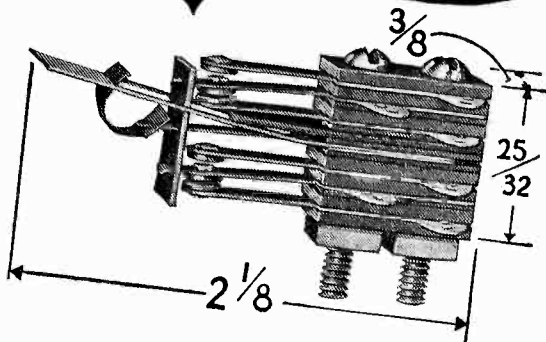

ACRO'S Patented Rolling Spring construction is widely preferred by prominent manufacturers for its inherent, positive snap action and long life. Permits a wide variation in operating characteristics, size and shape. Two pole design shown is made with either single or double throw contacts, with operating pressures from 3 to 5 oz. Movement differential $\frac{1}{16}$ ". Rating: 15 Amps, 125 Volts A.C. Write for print of Two Pole Switch illustrated or, better still, send us your own engineering details for quicker action.

ACRO ELECTRIC COMPANY
1316 SUPERIOR AVENUE • CLEVELAND 14, OHIO

Here's Your NEW **FREE**
ALLIED
CATALOG

Everything in
Radio &
Electronic
Supplies



Send for it Now
Complete, Expert Service
for Radio Engineers

Write for your FREE copy of the new ALLIED Catalog—the accepted Buying Guide for Radio and Electronic supplies. Get everything you need in your research and development work from a single dependable source with more than 20 years of radio supply experience. Largest stocks of parts, tubes, test instruments, public address equipment . . . send for your copy today!

ALLIED RADIO CORP., Dept. 24-D-7
833 W. Jackson Blvd., Chicago 7, Illinois

SEND FREE 1947 ALLIED CATALOG.

Name

Address

ALLIED RADIO

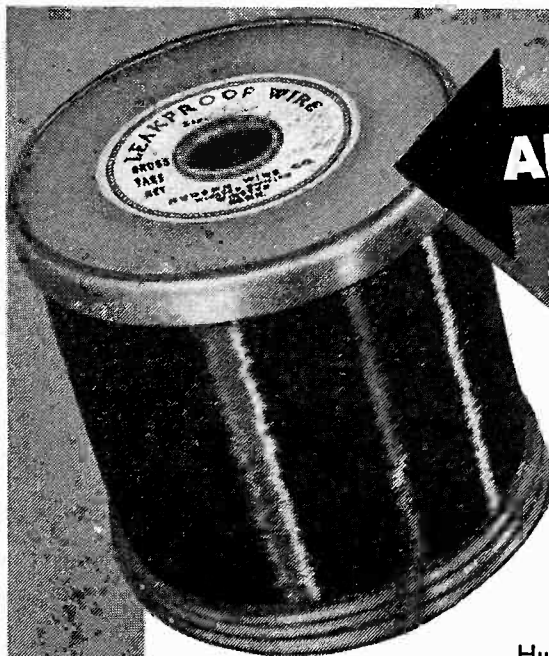

APPROVED

Leakproof
**ENAMELED
MAGNET WIRE**

• Much of the success of this Hudson Wire product is due to a new coating method that gives a smooth, permanently-adherent enameling. Mercury-process tests guarantee perfect uniformity; great tensile strength assures perfect laying even at high winding speeds. Especially adaptable for reduction in coil dimensions without sacrificing electrical values.

Our engineering and design facilities are at your disposal—details and quotations on request.

HUDSON WIRE COMPANY

Winsted Division

WINSTED

CONNECTICUT



HALLOWELL

"SOCKET SCREW" KIT
with interchangeable bits

For men who like to have a complete supply of tools, yet dislike bulk and confusion, the Hallowell "Socket Screw" Kits are the answer. Their hollow, durable plastic handles hold interchangeable *steel* bits for most all purposes . . . Phillips, Hex and Flat. They each have a swivel bit-chuck, which locks securely in five positions.

The "Socket Screw" Kit comes in 2 sizes: small #25 Kit; and the large #50 Kit.

Other Hallowell Kits: "Socket Wrench"; "Auto"; "Home".

Obtainable at Dealers throughout the country. If none near you, or he is sold out, send his name to us, along with yours, and you will be taken care of promptly.

Kits: Patents Pending

An ideal gift or prize

Over 44 Years In Business

STANDARD PRESSED STEEL CO.

JENKINTOWN, PENNA., BOX 596

Boston • Chicago • Detroit • Indianapolis
St. Louis • San Francisco

at Frequencies between 20 and 140 Mc—R. A. Soderman of General Radio Company.

Design Problems of F-M Receivers—Aldo Miccioli, associated with Dale Pollack.

Wartime Developments in Wave-Guide Theory—Julian S. Schwinger, Research Laboratory of Physics, Harvard University.

G-M Counter Laboratory

A NEW LABORATORY to test Geiger-Muller counters and associated electronic equipment has been established in the Radioactivity Section of the National Bureau of Standards. The laboratory will test performance qualities, utility, and construction of counters now being manufactured. It will aid purchasers by assisting them in formulating specifications. It will help manufacturers by accumulating test data and determining the types of counters necessary for various fields of scientific research. No attempt will be made at present to set up standard specifications because of lack of uniform types and design of counters.

Fellowships in Physics

FIFTY all-expense General Electric Science Fellowships will be given to high school and preparatory school teachers of physics in nine central and midwestern states, to enable teachers to review recent developments in physics in a six-week summer program at Case School of Applied Science in Cleveland from June 23 to August 1, 1947.

Applications must be sent in by April 15, to Dr. Elmer Hutchisson, Dean, Case School of Applied Science, Cleveland 6, Ohio. Teachers from Ohio, Michigan, western Pennsylvania, West Virginia, Kentucky, Indiana, Illinois, Wisconsin, and Maryland are eligible.

Eta Kappa Nu Awards

AFTER a lapse of five years, Eta Kappa Nu will resume the granting of Recognition Awards to outstanding young electrical engineers. Those who were eligible for the award during the war years will still be eligible even though now

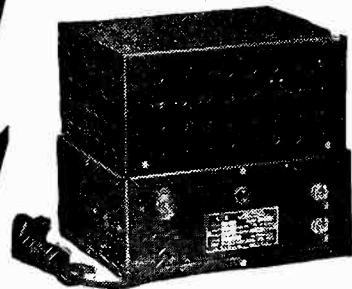

ATR "A"

BATTERY ELIMINATORS
FOR CONVERTING A.C. TO D.C.

New Models . . . designed for testing D.C. electrical apparatus on regular A.C. lines. Equipped with full-wave dry disc type rectifier, assuring noiseless, interference-free operation and extreme long life and reliability.

- Eliminates Storage Batteries and Battery Chargers.
- Operates the Equipment at Maximum Efficiency at All Times.
- Fully Automatic and Fool-Proof.

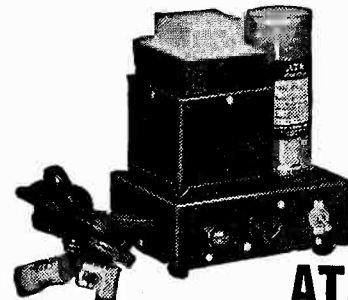

ATR

LOW POWER INVERTERS
FOR INVERTING D.C. TO A.C.

Another New ATR Model . . . designed for operating small A.C. motors, electric razors, and a host of other small A.C. devices from D.C. voltages sources.



ATR

STANDARD AND HEAVY DUTY INVERTERS
FOR INVERTING D.C. TO A.C.

Specially designed for operating A.C. radios, television sets, amplifiers, address systems, and radio test equipment from D.C. voltages in vehicles, ships, trains, planes, and in D.C. districts.

WRITE FOR NEW CATALOG—
JUST OFF THE PRESS!

AMERICAN TELEVISION & RADIO CO.

Quality Products Since 1931

ST. PAUL 1, MINN.

U. S. A.

**EISLER
ELECTRICAL & ELECTRONIC
EQUIPMENT
ELECTRONIC TUBE EQUIPMENT**

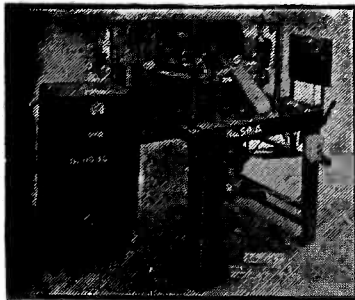

**24 HEAD
RADIO TUBE
EXHAUSTING
MACHINE**

◆
We Make Complete Equipment For The Manufacture Of Incandescent Lamps, Radio and Electronic Tubes.

TRANSFORMERS OF ALL TYPES

For
**LIGHTING
FURNACES
POWER
PHASE
CHANGING
DISTRIBUTION
ETC.**

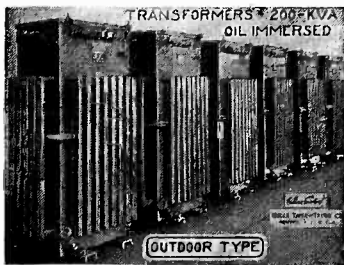

◆
Air, Oil,
or Water
Cooled

Sizes 1/4 To 250 KVA
SPOT WELDERS

OF ALL TYPES
FOR ALL PURPOSES
SIZES 1/4 TO 250 KVA
Butt Welders - Gun Welders
Arc Welders
Neon Sign Units
Fluorescent Tube
Manufacturing Equipment



**CHAS. EISLER
EISLER ENGINEERING CO., INC.**
751 So. 13th St. (Near Avon Ave.), Newark 3, N. J.

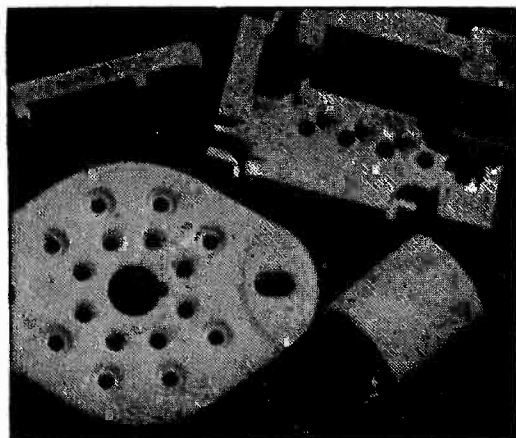

**Lavite STEATITE
CERAMIC**

Properties and Characteristics of Our
LAVITE S1-5 Steatite Ceramic Body

Compressive Strength	96,000 lbs. per square inch
Tensile Strength	7,200 lbs. per square inch
Flexural Strength	10,500 lbs. per square inch
Modulus of Rupture	20,000 lbs. per square inch
Dielectric Strength	235 volts per mil
Dielectric Constant	6.42
Loss Factor	2.90
Power Factor	.446
Bulk Specific Gravity	2.664%
Density (from above gravity)	0.096 lbs. per cubic inch
Hardness (Mohr scale)	7.0
Softening Temperature	2,350°F
Linear Coefficient of Expansion	8.13x10 ⁻⁶
Moisture Absorption (ASTM D-116-42-A)	0.009%

Design engineers and manufacturers in the radio, electrical and electronic fields are finding in LAVITE the precise qualities called for in their specifications . . . high compressive and dielectric strength, low moisture absorption and resistance to rot, fumes, acids, and high heat. The exceedingly low loss-factor of LAVITE plus its excellent workability makes it ideal for all high frequency application.

We will gladly supply samples for testing.

D. M. STEWARD MFG. COMPANY
Main Office & Works: Chattanooga, Tenn.
Needham, Mass. . . Chicago . . . Los Angeles

The Patent Guide You Have Been Waiting For!

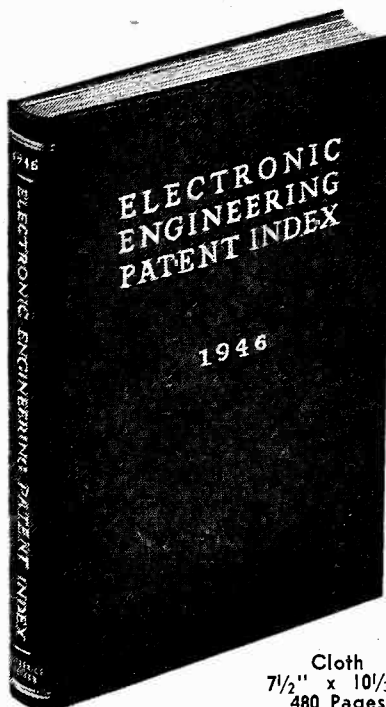

**ELECTRONIC ENGINEERING
PATENT INDEX, 1946**

A master compilation of over 2000 electronics patents arranged for rapid reference

During 1946 the U. S. Patent Office granted over 2000 electronics patents. Here in this single volume is the complete collection reproduced in entirety from the 52 weekly issues of the Patent Office Gazette issued during 1946. Each electronic patent included gives patent title, number, inventor, assignee, illustrations, etc. All patents are conveniently arranged under more than 150 subject headings. Here is a wealth of new information on circuits, components, manufacturing methods, etc.

Descriptive circular on request

Cloth
7 1/2" x 10 1/3"
480 Pages

Order Now. Edition Limited

PRICE **\$14.50**

**ELECTRONICS RESEARCH
PUBLISHING COMPANY**

2 WEST 46TH ST.
NEW YORK 19, N. Y.

Now Available. The 1946 Edition of
**ELECTRONIC ENGINEERING
MASTER INDEX**

Covering the important one and one-half year period from July 1945 to December 1946, and including over 300 miscellaneous entries, this supplement contains over 7500 new bibliographical listings arranged under more than 400 subject headings. A special feature is the 25 page classified compilation of MANUFACTURERS' CATALOGS.

Order Now. Edition Limited
230 pages \$14.50
Send for descriptive literature.

**TOROIDAL
COIL
FILTERS**

. . . are the answer
to any network problem

- SHARP CUT-OFF
- LOW INSERTION LOSS
- HUM PROOF
- COMPACT
- HIGH STABILITY

Toroidal Coils

Inductance—1 MHY to 3 HYS
Frequency—300 cy. to 30,000 cy.
Q—55 at 1000 cy; 150 at 3000 cy.

Ask to be put on mailing list for complete catalogue of coils and filters.

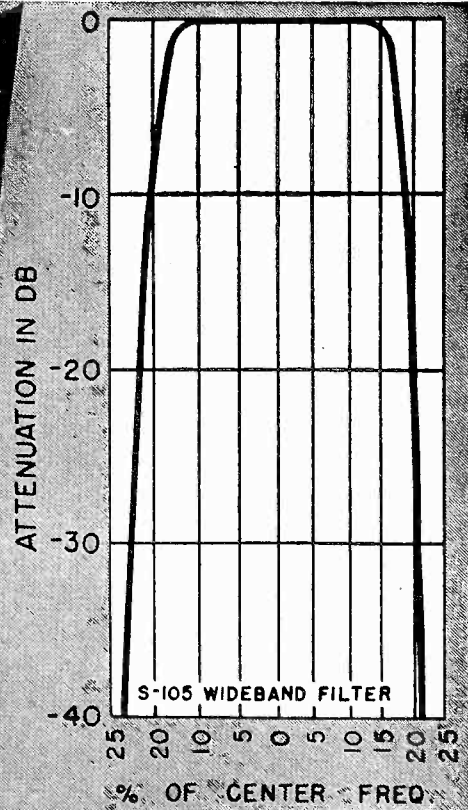

S-105 WIDEBAND FILTER

% OF CENTER FREQ

Actual measurements taken on Toroidal Coil Filter manufactured by Burnell & Co.

Burnell & Co.

Designers and Manufacturers
of Electronic Products

10-12 VAN CORTLANDT AVE. EAST, BRONX 58, N. Y., Sedgwick 3-1593

The Shape and Size YOU need!

PARAMOUNT SPIRAL WOUND PAPER TUBES

All Sizes in Square and Rectangular Tubes

Leading manufacturers rely on the quality and exactness of PARAMOUNT paper tubes for coil forms and other uses. Here you have the advantage of long, specialized experience in producing the exact shapes and sizes for a great many applications. *Hi-Dielectric, Hi-Strength.* Kraft, Fish Paper, Red Rope, or any combination. Wound on automatic machines. Tolerances plus or minus .002". Made to your specifications or engineered for YOU.

SEND FOR ARBOR LIST
OF OVER 1000 SIZES
Inside Perimeters from
.592" to 19.0"

Convenient. Helpful. Lists
great variety of stock ar-
bors and tube sizes. In-
cludes many odd sizes.
Write for Arbor List today.

PARAMOUNT PAPER TUBE CORP.

616 LAFAYETTE ST., FORT WAYNE 2, IND.

Manufacturers of Paper Tubing for the Electrical Industry

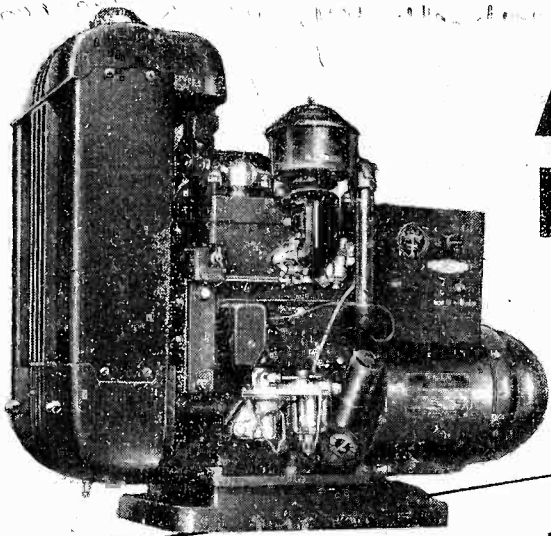

A.C. OR D.C. POWER

PORTABLE,
STANDBY OR
STATIONARY

You can simplify any power-for-electronics problem with an ONAN Electric Plant. A wide range of models and sizes makes it easy to choose the right plant for the particular application.

Lightweight one or two-cylinder air-cooled models for easy portability—A.C.—350 to 5,000 watts, D.C.—600 to 5,000 watts.

Onan two, four and six-cylinder water-cooled models are built for continuous heavy-duty operation, stationary or mobile. A.C.—3,000 to 35,000 watts in to 10,000 watts.

ONAN Electric Plants: A.C.—350 to 35,000 watts in standard voltages and frequencies. D.C.—600 to 10,000 watts, 115 and 230 volts. Battery chargers—500 to 6,000 watts, 6 to 115 volts.

D. W. ONAN & SONS INC.
3 5 6 1 Royalston Ave. Minneapolis 5, Minn.

For—
Radio Station Standby
Geophysical Survey
Railroad Radio
"Spot" Recording
Mobile Radio Units
Municipal Signal Standby
Amateur Radio
Write for Folder



ONAN ELECTRIC PLANTS

nominally beyond the limits specified in the conditions of the award (under 35 years of age, and not more than 10 years out of college). Accordingly, if sufficient and suitable candidates are nominated, it may be possible in 1947 to name a Recognition winner (and Honorable Mentions) for each of the six years from 1942 through 1947. Except for those few who do not meet the age requirements, all E.E. graduates in the class of 1932 or later will be eligible for honors in one or more of the above years.

The names of the past winners and their present positions are:

1936—Frank M. Starr, Sales Engineer, General Electric Co.

1937—C. Guy Suits, Vice-President and Director of Research, General Electric Co.

1938—Winston E. Kock, Research Department, Bell Telephone Laboratories, Inc.

1939—Larned A. Meacham, Research Department, Bell Telephone Laboratories, Inc.

1940—Jesse E. Hobson, Director, Armour Research Foundation

1941—Cledo Brunetti, Chief, Project Engineering Section, National Bureau of Standards

Nominations for the award should be sent to Mr. A. B. Zerby, Executive Secretary, Eta Kappa Nu, P. O. Drawer C, Dillsburg, Pa. As much information as possible should be given about the nominee; the award committee will go on from there. There is no limit on the number of candidates who may be proposed by any nominator. Achievement of the nominee may be all or in part in any field including industrial, educational, political, research, civic, artistic, athletic, etc.

By the conditions of the award, a young engineer with high technical achievements plus exceptional activity in civic and social affairs will have the greatest chance of winning the coveted Recognition. All nominations must be mailed by May 1, 1947. The awards for the several years will be made at a banquet to be held during the AIEE midwinter meeting in January 1948.

1947 Chicago IRE Conference

DR. W. R. G. BAKER, IRE president, will make the opening address at a one-day technical conference to be held April 19 at Northwestern Technological Institute, Chicago. Conducted tours through the Institute's laboratories and demonstrations of the electron microscope, servomechanisms, a high-voltage surge gen-

HOT IN 90 SECONDS

America's Only Soldering Iron with **BUILT-IN THERMOSTAT**



—Two KWIK-HEAT Built-in Thermostatic irons, 225-watt and 450-watt, plus our low cost KOPPERKORE 100-watt iron. The Kordless KWIK-HEAT facilitates production of small work. See KWIKHEAT demonstrated at your Radio, Electrical or Hardware distributor, or write for data:

HOT IN 90 SECONDS



JONES 400 SERIES PLUGS and SOCKETS

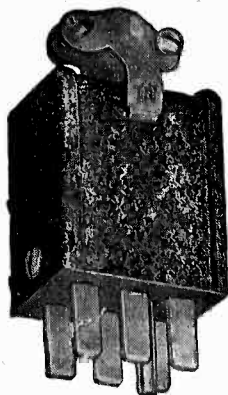

P-406-CCT

A medium size Plug and Socket that fulfills practically every requirement in the public address, radio and kindred fields. Socket contacts are of phosphor bronze, cadmium plated.

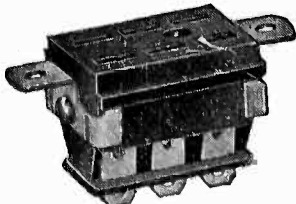

S-406-AB

Plug contacts are of hard brass, silver plated. Insulation is of molded Bakelite. All Plugs and Sockets are Polarized.

Made in 2, 4, 6, 8, 10 and 12 contacts. Caps are of steel with baked black crackle enamel. A quality item at popular prices. Send today for catalog No. 14 listing complete line of Jones Electrical Connecting Devices—Plugs, Sockets and Terminal Strips.

HOWARD B. JONES DIVISION
CINCH MFG. CORP.
2460 W. GEORGE ST. CHICAGO 18

ANOTHER SPECIAL BY PROGRESSIVE

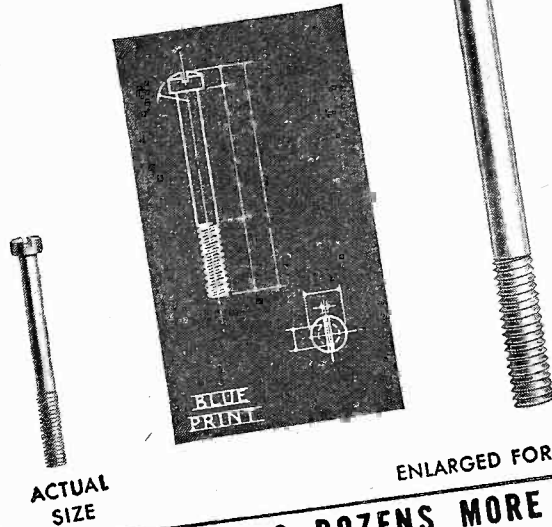

ACTUAL SIZE

ENLARGED FOR DETAIL

CATALOG SHOWS DOZENS MORE

Special heads, threads and finishes on any metal or alloy adapted to cold upset. Weekly output: 25,000,000 pieces. Many specials, suggesting production savings for you, illustrated in latest catalog. Includes weights per 1M standard pieces, dec. equivs. of fractions, other purchasing and engineering helps. Write for Catalog 18.

The PROGRESSIVE MFG. CO.
50 NORWOOD ST. TORRINGTON, CONN.



THERMOSTATIC METAL TYPE DELAY RELAYS

PROVIDE DELAYS RANGING FROM 1 TO 120 SECONDS

FEATURES:—Compensated for ambient temperature changes from -40° to 110° F . . . Hermetically sealed; not affected by altitude, moisture or other climate changes . . . Explosion-proof . . . Octal radio base . . . Compact, light, rugged, inexpensive . . . Circuits available: SPST Normally Open; SPST Normally Closed.

PROBLEM? Send for "Special Problem Sheet" and Bulletin.

AMPERITE REGULATORS

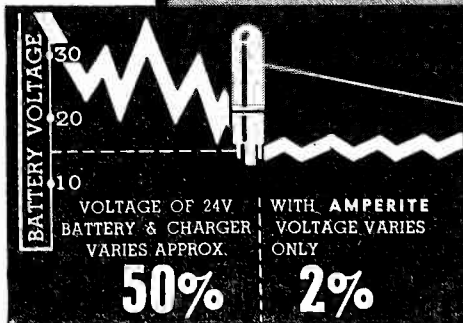

Amperite REGULATORS are the simplest, lightest, cheapest, and most compact method of obtaining current or voltage regulation . . . For currents of .060 to 8.0 Amps . . . Hermetically sealed; not affected by altitude, ambient temperature, humidity.

Write for 4-page Illustrated Bulletin.

AMPERITE CO., 561 Broadway, New York 12, N. Y.

In Canada: Atlas Radio Corp., Ltd., 560 King St., W. Toronto

A discussion of
electronics in action

ELECTRONICS for INDUSTRY

BY WALDEMAR I. BENDZ

Westinghouse Electric Corporation, Boston, Mass.
Assisted by CHARLES A. SCARLOTT, Editor,
"Westinghouse Engineer"

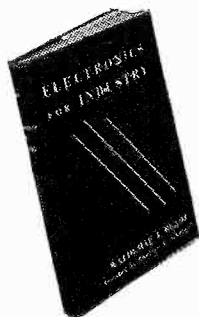

This new book clearly and concisely explains the principles of industrial electronics, describing the various types of electronic tubes, their functioning and the basic circuits in which these are used in many industrial devices. Electronics is discussed from the physical point of view. Numerous diagrams, rather than the usual mathematical explanations, help clarify the discussions. Photographs and brief explanations throughout the text show the tasks performed by many electronic devices in industry. Presupposing an understanding of the fundamentals of electric circuits, ELECTRONICS FOR INDUSTRY does not concern itself with detailed proof of theories. However, numerous footnotes refer the reader to other sources for the study of theory and specific design. Each chapter concludes with a summary of the important points discussed, plus a carefully prepared reference list for further detailed study of each subject.

Subjects discussed are—

- MEET THE ELECTRON
- ELECTRON ESCAPE FROM SOLIDS—EMISSION
- ELECTRICITY FROM LIGHT
- ELECTRICITY INTO LIGHT
- TWO-ELEMENT TUBES
- THREE-ELEMENT PLOTIONS
- MULTIGRID PLOTIONS
- THYRATONS
- FROM ALTERNATING TO DIRECT CURRENT
- MERCURY-POOL TUBES
- AMPLIFICATION
- PRINCIPLES OF OSCILLATION
- MODULATION AND DETECTION OF CARRIER WAVES
- HEATING BY HIGH FREQUENCY
- BASIC CIRCUITS OF ELECTRONIC CONTROL
- INDUSTRIAL APPLICATION OF ELECTRONIC CONTROL
- ELECTRONIC REGULATORS

March 1947 501 Pages \$5.00

ON APPROVAL COUPON

JOHN WILEY & SONS, INC.
440 Fourth Avenue, New York 16, N. Y.
Please send me a copy of Bendz' & Scarlott's
ELECTRONICS FOR INDUSTRY on ten days'
approval. If I desire to keep the book, I
will remit \$5.00 plus postage; otherwise, I
will return the book postpaid.

Name.....
Address.....
City..... State.....
(Approval offer not valid outside U. S.)

erator, and microwave optics will supplement presentation of the following papers:

- A Magnetic Compass with Cathode-Ray Sensing Element—W. H. Kliever of Minneapolis-Honeywell Regulator Co.
- Photocells and Low-Noise Amplifiers—Dr. H. S. Snyder, Physics Dept., Northwestern Technological Institute.
- Patents and the Engineer—Curtis F. Prangley, patent attorney.
- A Compact Electromechanical Filter for the 455-KC I-F Channel—Dr. R. Adler of Zenith Radio Corp.
- A Viscous Termination Crystal Pickup—Thomas E. Lynch of Brush Development Co.
- Factory Testing of Television Receivers—Dean Shankland of Farnsworth Radio & Television Corp.
- Crystal Synthesizer—member of Collins Radio Co.
- R-F Performance of Some Receiving Tubes for Television—R. Cohen of RCA Tube Division.
- Mobile Radio Telephone—P. R. O'Connor of Illinois Bell Telephone Co.
- A Variable-Frequency Oscillator with Narrow-Band F-M—Leonard Mayberry of Hallicrafters Co.
- Personal Plane Radio—R. S. Bowditch of Galvin Mfg. Corp.
- F-M Monitor—C. A. Cady of General Radio Co.
- Phase Shift Modulator—M. Marks of Raytheon Mfg. Co.
- A System of High-Efficiency Modulation Applied to Television—J. F. Bell of Zenith Radio Corp.

RMA Spring Meeting

FRED R. LACK, RMA director and vice-president of Western Electric Co., will speak on "Thirty Years in Transmitter Design" at a dinner Tuesday evening April 29 in connection with the Spring Meeting of the RMA Engineering Department, to be held at the Hotel Syracuse, Syracuse, N. Y. April 28-30. Technical sessions will include the following papers:

- Absolute vs Industrial Standardization—C. H. Crawford of General Electric Co.
- Characteristics and Circuit Applications of a New Low-Power Tetrode—H. C. M. Longacre of Sylvania Electric Products Inc.
- Color Television Transmitter Design in the UHF—J. P. Wilmer of Columbia Broadcasting System.
- Design Consideration in an Automatic Gain Control and Limiting Amplifier—William Jurek of Langevin Co.
- Frequency-Modulated Link—E. Ostlund of Federal Telecommunications Laboratories.
- Design Considerations for Commercial Radar Equipment—Coleman London of Westinghouse Electric Corp.
- Television Studio Control Including Camera Dolly Considerations—C. E. Hallmark of Farnsworth Television & Radio Corp.
- Navigational Computers—A. C. Omberg of Bendix Aviation Corp.

MEETINGS

MARCH 31-APRIL 2: Midwest Power Conference, Palmer House, Chicago; technical sessions at 3:30 p.m. April 1 and 9 a.m. April 2 covering Electronics in Industry.

APRIL 19: 1947 Chicago IRE Conference, Northwestern Technological Institute, Chicago; three concurrent technical sessions starting at 10 a.m. and 2 p.m., with a total of

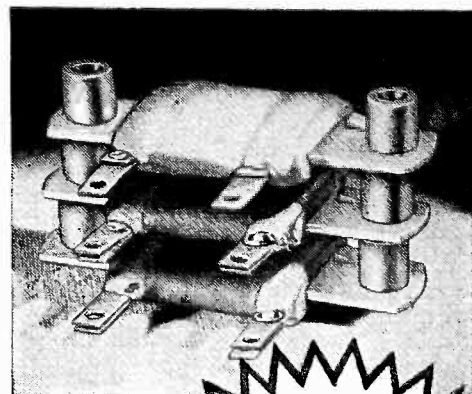

**Stacked
RESISTORS**

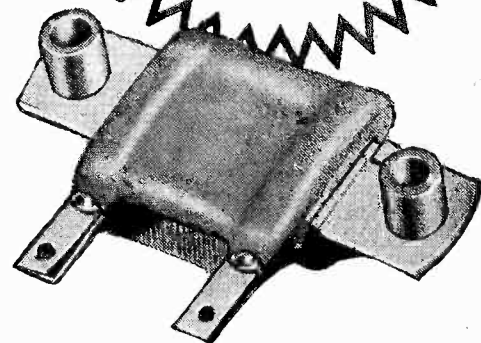

★ Flat-type Series ZT Greenohms are designed for handy stacking whereby two or more units can be banked and connected together or separately as required. Just the thing for high wattage in tight spots. And just another touch of Clarostat versatility . . .

In five standard sizes and wattage ratings—30, 40, 55, 65 and 75 watts.
Respective resistance maximums of 10,000, 20,000, 35,000, 50,000 and 60,000 ohms.

Flatted ceramic tube on metal strip with mounting collars riveted thereto. Resistor completely insulated.

Mounting screws or rods slipped through aligned mounting collars. Rigid assembly.

Adequate spacing between units for free circulation of air and good heat dissipation.

★ Write for Bulletin 113 containing complete engineering data on this and other types of famous Greenohm wire-wound resistors.



CLAROSTAT MFG. CO., Inc. • 285-7 N. 6th St., Brooklyn, N. Y.

For YOU!

We'll take POSJ * POT * SV * SJ *
2, 3 and 4 conductor. S, 2 and 3 con-
ductor and heater cord.

We'll make it
into CORD SETS
with Electrix, Al-
lied, Glade,
Carling or Gil-
bert plugs.



We'll put on Eye-
lets, - Lugs, -
Connectors -
Ground Jacks, -
Loops, - Mark-
ers, - Etc.

We'll attach Diamond, - Soreng, - Wood-
win Female Plugs or Cutler-Hammer,
Carling heater attachments, or feed
thru switches.

We'll make up any special types of
cord set or cable you require. Samples
and Prices on request.

COLUMBIA WIRE AND SUPPLY COMPANY

5734 North Elston Ave.

Chicago 30, Ill.

Spring 1955



THE
PROOF'S
IN THE
USE

RUBYFLUID FLUX
IS Better for All Soldering
RUBY'S BIG \$1 SAMPLE —

1 pt. of liquid and 1/2 lb. of
paste flux is more than
enough to show you why we
say Rubyfluid is a better flux.

Rubyfluid—

Wets out freely . . .
Makes stronger neater
joints . . .
Has no harmful fumes . . .
Acts quickly and saves
time . . .

Ruby also will send you free
its new booklet of simplified
instructions on "How To
Solder."

Write for the Sample and Booklet Today



RUBY CHEMICAL CO.
59 McDOWELL STREET
COLUMBUS 8, OHIO

Rubyfluid

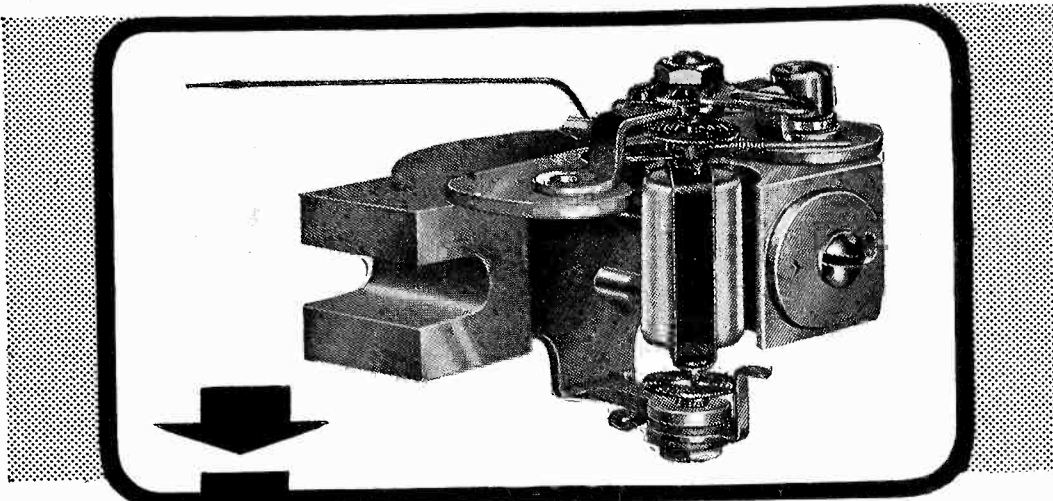

Burlington
INSTRUMENTS

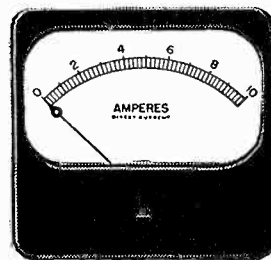

Precision Movement • Dependability Unlimited

Alnico Magnets in all DC Instruments—Phosphor bronze control springs—perfectly
aligned jewel supports—non-shifting balance weights—added to its many other
superior construction features enables Burlington Instruments to maintain critical
characteristics.

All ranges AC or DC available in 2 1/2", 3 1/2", 4 1/2" sizes, rectangular and round.

Inquiries invited for your specific requirements.

BURLINGTON INSTRUMENT COMPANY 117 FOURTH ST.
BURLINGTON, IOWA

**ZERO
DISTORTION?**

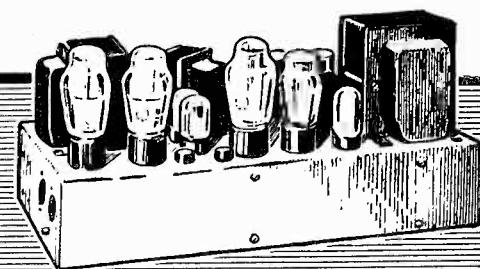

NOT QUITE — but very close to it

**The BROOK HIGH QUALITY
AUDIO AMPLIFIER**

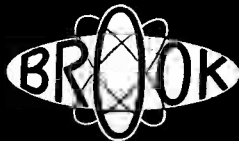

BROOK ELECTRONICS
Inc.

34 DeHart Place
Elizabeth 2, N. J.

Designed by LINCOLN WALSH

Distortion is reduced to extremely low levels
previously unattainable.

The Brook amplifier uses triode tubes exclu-
sively, a patented circuit, and has 30 watts
power output.

Cabinet or rack mounting. Prompt delivery.

WRITE FOR DETAILS

NO. **3**
OF A SERIES

Carter

rides the **ROCKETS**
in **U. S. ARMY TESTS**
over **100 Miles Up!**

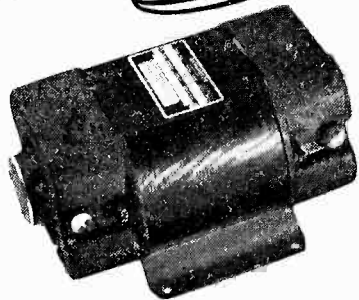

To assure reliable performance, **Carter Genemotors** are specified to power scientific recording instruments in U.S. Army V-2 Rockets, and operate perfectly over 100 miles above the earth. **CARTER**—Unequaled power for Aircraft, Marine, Police and all mobile communications. Full output in 3/10 second, over 100,000 transmissions guaranteed. Write for Catalog.

Carter Motor Co.
Chicago, Illinois

2648 N. MAPLEWOOD AVENUE • CABLE: GENEMOTOR

ROBINSON

Precision
Belt-Driven

Turntables

- ★ Chassis consists of heavy cast aluminum bed plate. Turntable also heavy aluminum casting with deep skirt extending through bed plate as pulley for driving belt.
- ★ Oversized motor and transmission mounted on heavy brass sub-base — "Seismic Mounting"—suspended on anti-resonant springs.
- ★ Two-speed transmission operates from toggle lever. Shifts speed from 78 to 33 $\frac{1}{3}$ in one second! Starts to synchronous 33 $\frac{1}{3}$ speed in $\frac{1}{4}$ revolution. No over-swing!
- ★ Micrometer speed adjustment (patented) insures exact speed. Silent mercury switch built-in. The world's finest turntable.

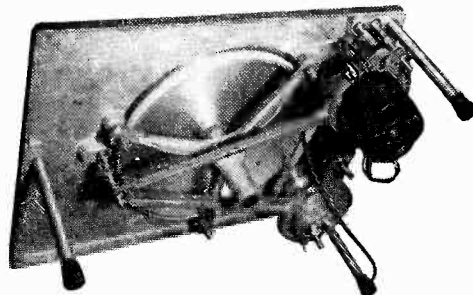
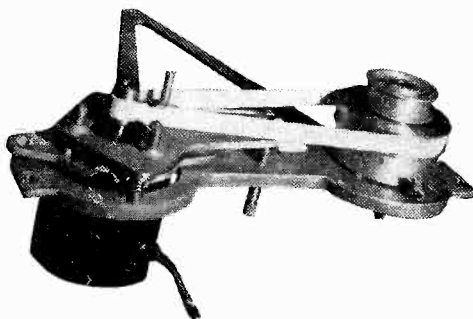

Console \$90 Chassis \$295
Duplex Console \$150
Transcription Tone Arm \$74.50
With G. E. Var. Rel. Cartridge

ROBINSON RECORDING LABORATORIES
35 SO. NINTH ST., PHILADELPHIA 7, PA.

NEWS OF THE INDUSTRY (continued)

14 papers; chairman—H. S. Renne, Room 2114, 185 N. Wabash Ave., Chicago.

APRIL 21-25: SMPE semiannual convention, Drake Hotel, Chicago.

APRIL 28-30: RMA Spring Meeting, Hotel Syracuse, Syracuse, N. Y.; technical sessions.

APRIL 28-MAY 9: International Merchant Marine Radio Aids to Navigation meetings; first week at Hotel Roosevelt, New York City; second week on three ships working out of New London, Conn.

MAY 3: IRE spring technical conference in Cincinnati, featuring television papers and exhibits; information—E. J. H. Bussard, The Crosley Corp., Cincinnati.

MAY 4-8: National Electrical Wholesalers Association meeting, Traymore Hotel, Atlantic City, N. J.

MAY 6-10: National Plastic Exposition, sponsored by The Society of the Plastics Industry, in the Coliseum, Chicago.

MAY 13-16: 1947 Conference and Show by Radio Parts and Electronics Equipment Shows, Inc., Chicago.

MAY 17: New England Radio Engineering Meeting of North Atlantic Region of IRE; six technical papers, luncheon, and banquet at Continental Hotel, Cambridge, Mass.

BUSINESS NEWS

THE HALLICRAFTERS Co., Chicago, has moved into their new plant at 4401 W. Fifth Ave.

AUTOMATIC ELECTRIC Co., Chicago, has acquired rights under Finch patents to manufacture and sell or lease Finch facsimile equipment.

SHAKEPROOF INC., Division of Illinois Tool Works, Chicago, has been licensed by Tinnerman Products, Inc., Cleveland, Ohio, to manufacture and market fasteners on which Tinnerman holds patents.

UNITED AIR LINES has been installing Sperry A-12 electronic autopilots, incorporating automatic approach controls, in all its four-engined Mainliner 230 planes and has ordered similar equipment from Eclipse-Pioneer Division of Bendix

ELECTRONIC ENGINEERS

Seniors and Juniors

Wanted by

The Federal Telephone & Radio Corp.

well versed in all phases of transmitter design; only Graduate Engineers with either engineering degree or equivalent training in this type of work will be considered.

Good Salary—Steady Positions

Excellent opportunities for advancement. Give complete background, experience, education & employment history. Address letter to Personnel Manager.

FEDERAL TELEPHONE & RADIO CORP.
Newark 1, N. J.

NEW SOLDERING GUN

Heats in 5 Seconds



SPECIAL SOLDERING GUN ADVANTAGES

TIP STAYS TINNED
NO BURNING



SEE WHERE
YOU SOLDER

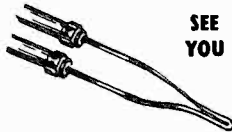

SOLDER AROUND
CORNERS



Service and maintenance men can save time by the fast heating of the Soldering Gun. By use of the new induction principle, 5 second soldering heat is supplied from a light weight built-in transformer.

The loop type tip gives you other advantages that are important in soldering. Good balance with weight close to your hand makes it easier to use. The narrow tip gets in between a lot of wiring with ease. Connections can be made without burning insulation. The tip can be formed readily to work in tight places.

See your radio parts distributor for a demonstration, or write direct for descriptive bulletin.

- ★ 100 Watts 115 Volts 60 Cycles
- ★ Intermittent Operation With Trigger Switch
- ★ Can't Overheat or Burn Out
- ★ Impact Resisting Case
- ★ Handle Stays Cool
- ★ Good Balance—Weight Close To Hand

806 Packer Street

WELLER MFG. CO. • Easton, Pa.

Export Dept.—25 Warren Street, New York 7, N. Y.

In Canada—Atlas Radio Corp., Ltd., 560 King Street N. W., Toronto, Ont.

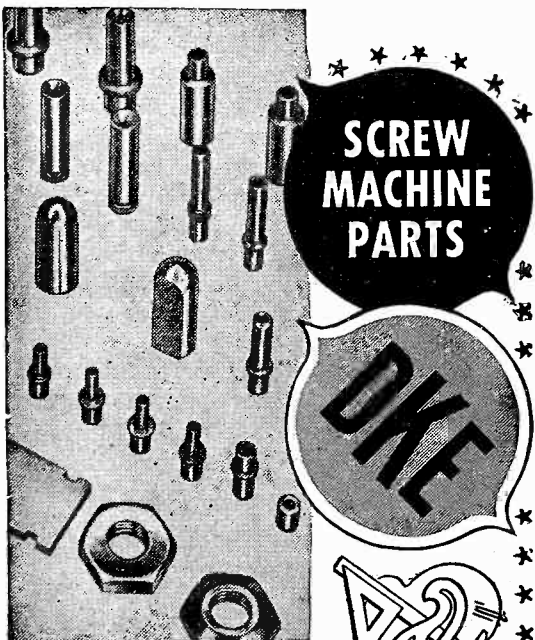

SCREW MACHINE PARTS

DKE

...for exacting needs!

Facilities for rapid production of all screw machine parts. Close tolerance work a specialty. Expanded modern facilities permit fast delivery. All tools, jigs, fixtures produced on premises for precision and economy.

INQUIRIES INVITED

THE ENGINEERING CO.

DANIEL KONDAKJIAN
27 WRIGHT ST., NEWARK, N. J.



Still the Leader

WINCHARGER TOWERS

The surging, booming post-war rush of radio broadcast construction finds Wincharger again supplying the industry with the bulk of its towers. And for the same reasons. Wincharger's guyed tower, with its uniform sections and resulting mass-production economy, continues to be the industry's recognized dollar-and-cents value. The convenience of Wincharger's "packaged-buying" and Wincharger's reliable maintenance and service, continue to be powerful attractions. FM broadcasters are following in the footsteps of the AM industry in likewise choosing Wincharger Antenna Tower Supports.

All Wincharger towers come completely equipped and ready for installation. This includes necessary lighting such as a 300 MM beacon, flasher, obstruction lights, wire, conduit, fuse box. No extras to buy—easy to erect. No wonder Wincharger Towers continue to be the industry's favorite.

FM ANTENNAS

The new, ultra-high-frequencies are an old story to the engineers who developed Wincharger's FM Folded Dipole Antenna. Pre-war FM experts, they set to work during the war to create some of the Armed Forces' finest radar equipment. And now again the Wincharger FM Folded Dipole Antenna has, without a doubt, the finest engineering in the industry.



WINCHARGER Corporation SIOUX CITY, IOWA, U. S. A.



What does it take to WAKE you up?

Present-day expansion of the radio-electronics industry is almost UNBELIEVABLE. The tremendous growth of the art is so rapid and the demand for TECHNICALLY QUALIFIED radiomen so great, that there are MORE GOOD JOBS than there are capable men to fill them.

OPPORTUNITY IS HERE . . . Now! Every page in Electronics could be filled with astounding facts concerning career opportunities available to trained radiomen. The point is what are you going to do about it? Just figure out for yourself how many good jobs are waiting to be filled. You can't say, "I don't need more training." EVERY radioman needs to increase his technical knowledge if he wants to keep ahead of the competition that is bound to come . . . if he wants to go after—and GET—the better jobs that offer good money and personal security.

If you have a commonplace job. If you have the ambition to hold a position of greater responsibility with higher pay . . . then a CREI spare time program for self-improvement will help you accomplish your ambition at this opportune time. It costs you nothing to read the interesting facts. Write today for complete details and the list of CREI radio-engineering courses.

CAPITOL RADIO ENGINEERING INSTITUTE

An Accredited Technical Institute
Dept. E-4, 16th & Park Rd., N. W.
WASHINGTON 10, D. C.

MAIL COUPON FOR FREE BOOKLET

CAPITOL RADIO ENGINEERING INSTITUTE
16th & Park Road, N. W., Dept. E-4, Wash. 10, D. C.
Gentlemen: Please send me your free booklet, "CREI training for your better job in RADIO-ELECTRONICS", together with full details of your home study training. I am attaching a brief resume of my experience, education and present position.

CHECK PRACTICAL RADIO ENGINEERING COURSE PRACTICAL TELEVISION ENGINEERING

NAME

STREET

CITYZONE.....STATE.....

I am entitled to training under the G. I. Bill.

for planes to be delivered in 1947 and 1948. After training of flight personnel with the aid of Link trainers equipped with new Curtiss-Wright devices for simulating automatic airport approach, instrument approach will be adopted as standard procedure.

GENERAL ELECTRIC Co. is constructing a 50-kw f-m transmitter at its

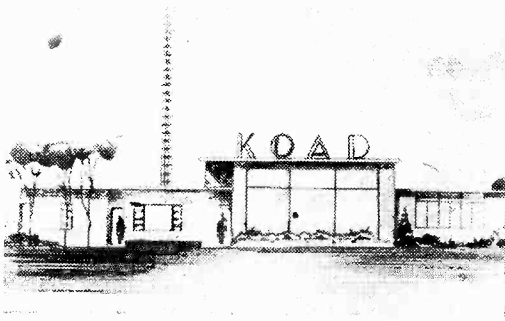

New modern transmitter building that will house the 50-kw f-m transmitter of KOAD, on a 40-acre plot southwest of Omaha Syracuse, N. Y. plant for station KOAD in Omaha, Nebraska.

THE DONALD M. MACMILLAN Co., Bergenfield, N. J. has been newly formed to provide electronic research, development, and design service for industrial clients.

TIMES FACSIMILE CORPORATION is the new name chosen to more adequately describe the activities of Times Telephoto Equipment Inc., New York City. Products now being manufactured by this subsidiary of the New York Times Co. include page-type transmitters, photographic recorders, direct recorders, transceivers for 12 x 18-inch copy, tuning fork-controlled a-f oscillators, and facsimile recording papers.

JEFFERSON ELECTRIC Co. has purchased from WAA a modern plant in Fall River, Mass., used during the war by Submarine Signal Corp. Floor area is approximately 250,000 sq ft and full operation will require over 1,200 workers.

ATLAS SOUND CORP., Brooklyn, N. Y. has purchased a fireproof modern building that will provide additional production space for loudspeakers and associated sound equipment.

KSD-TV, ST. LOUIS, claims to be the first completely postwar television station to go into operation on a regular schedule. Much of the equipment, including supersensitive RCA image orthicon cameras,

BRADLEY

PHOTO ELECTRIC CELLS



Unmounted Cells

The shapes of Luxtron photocells vary from circles to squares, with every in-between shape desired. Their sizes range from very small to the largest required.

In addition to the unmounted cells shown here, Bradley also offers cells in a variety of standard mountings, including plug-in and pigtail types.

For direct conversion of light into electric energy, specify Bradley's photocells. They are rugged, lightweight and true-to-rating.

Illustrated literature, available on request, shows more models of Bradley photocells, plus a line of copper oxide and selenium rectifiers. Write for "The Bradley Line."

BRADLEY LABORATORIES, INC.

82 Meadow St. New Haven 10, Conn.

**THIS SCREW
IS REALLY**

Twins



It may look like just one screw to you — but it's really twins, because it's doing the work of two screws — doing it cheaper and doing it better. A well-known manufacturer of household appliances (name on request) thought his product had too many screws and asked our Engineering Department. We thought so, too, and developed this single screw which works better and costs less. It will take only a three-cent stamp and a minute of your secretary's time to find out what we can do for you.

NEW ENGLAND SCREW CO.

Manufacturers of Special Screws

KEENE, NEW HAMPSHIRE

TERMINALS FOR ELECTRIC WIRES

*Condenser Plates
Small Metal Stampings
in accordance with
Customer's Prints*

- ACCURACY
- PRECISION
- REASONABLE
DIE CHARGES

Modern Equipment
and Factory
NO SCREW MACHINE PARTS

**PATTON-MACGUYER
COMPANY**

17 VIRGINIA AVE.
PROVIDENCE, R. I.

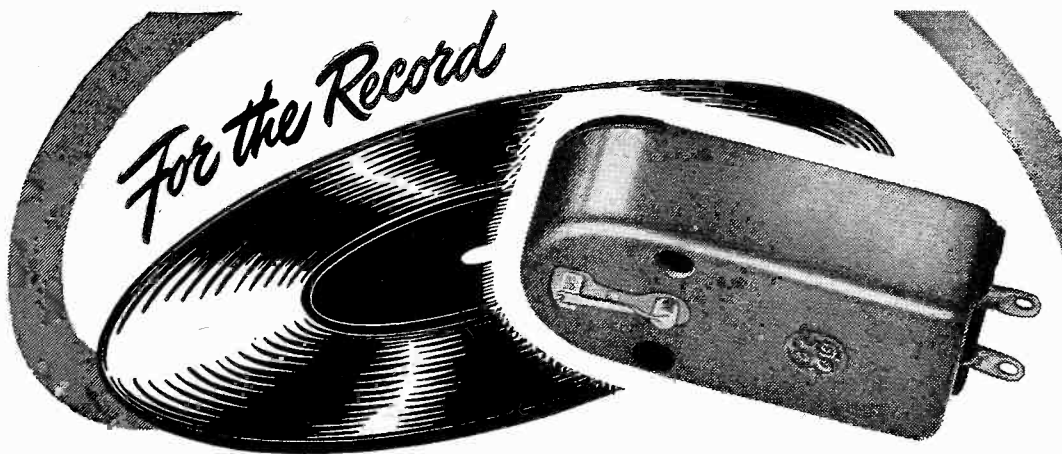

THE GENERAL ELECTRIC VARIABLE RELUCTANCE PICKUP

RECORD enthusiasts are critical customers—whether they be devotees of Bach or boogie-woogie. Better and better reproduction of their favorite recordings is an insistent demand that must be met.

The General Electric Variable Reluctance Pickup can help you to meet that demand. It will appeal immediately to the technical mind due to its simplicity and direct resolution of difficulties often associated with phonograph pickups.

Check this list of major features:

- Low Needle Talk
- Negligible needle scratch
- Low Distortion
- Permanent sapphire stylus
- Minimum record wear
- Frequency response
30-10000 cycles
- Not affected by adverse
climatic conditions

For complete information write to:

General Electric Company, Electronics Department, Syracuse 1, N.Y.

GENERAL  ELECTRIC

168-71

MASSIVE WINDING CORE 25% More Capacity

Another exclusive Hardwick-Hindle advantage is this great ceramic core of unusually large cross section for the wattage rating—more wire, more surface and, less temperature rise.

And between this ceramic winding core and the rugged die cast base there is ample space for full ventilation to insure low operating temperature for the mounting panel.

This is only one of several exclusive features. Let us tell you of other Hardwick-Hindle advantages in this and in other rheostats, as well as in our resistors.

Our engineering service is always available for specific problems. Write us today.

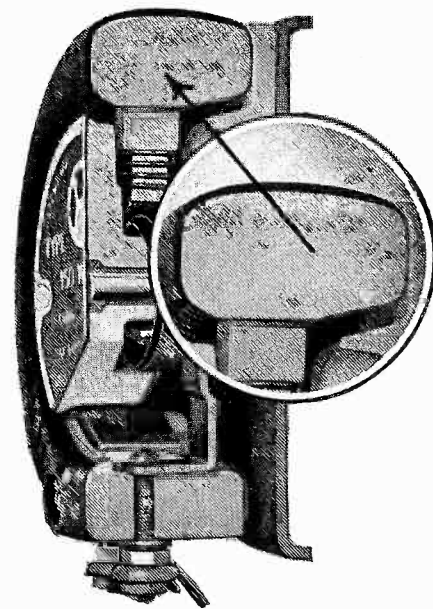

HARDWICK, HINDLE, INC.
RHEOSTATS and RESISTORS

Subsidiary of THE NATIONAL LOCK WASHER COMPANY
NEWARK 5, N. J. ESTABLISHED 1886

U. S. A.

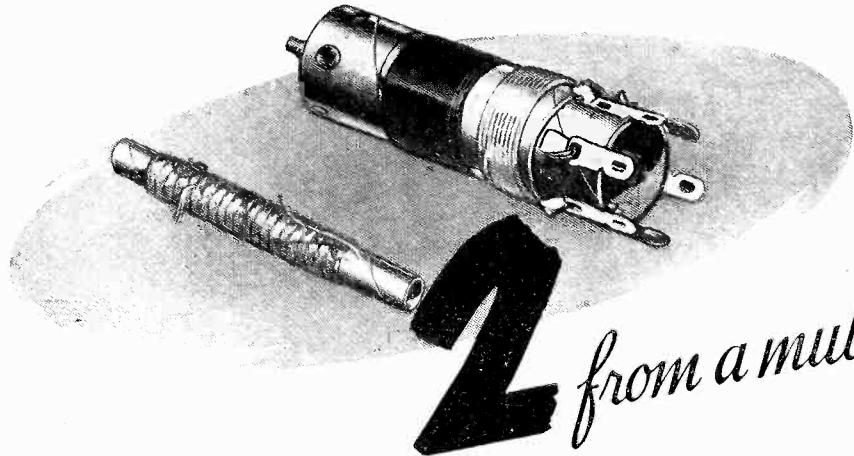

for experienced
cooperation
"call Cleveland"

of applications of

COSMALITE*

a spirally laminated paper base Phenolic Tube

#96 Cosmalite . . . for coil forms in all standard broadcast receiving sets.

SLF Cosmalite for permeability tuners.

Advantages include lower costs and quicker deliveries.

Ask also about our spirally wound kraft and fish paper Coil Forms and Condenser Tubes.

* Trade mark registered.

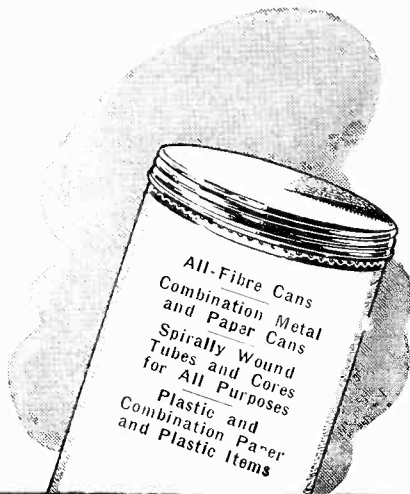

The **CLEVELAND CONTAINER Co.**
6201 BARBERTON AVENUE CLEVELAND 2, OHIO

PRODUCTION PLANTS also at Plymouth, Wisc., Ogdensburg, N. Y., Chicago, Ill., Detroit, Mich., Jamesburg, N. J.
PLASTICS DIVISIONS at Plymouth, Wisc., Ogdensburg, N. Y. • ABRASIVE DIVISION at Cleveland, Ohio
New York Sales Office—1186 Broadway, Room 223
IN CANADA—The Cleveland Container Canada Ltd., Prescott, Ontario

UNIVERSITY REFLEX CONSTRUCTION

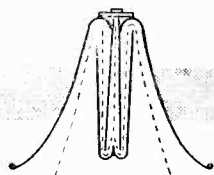

Engineered for
efficiency and quality

University Speakers

The conversion efficiency of UNIVERSITY loudspeakers over the useful speech frequency range is 35 to 50 percent! Parallel to this superior sensitivity, is naturalness of tone and a ruggedness which permits every model to be unconditionally guaranteed for one year. Magnets of higher magnetomotive force, greater rigidity and concentricity of voice coils resulting in smaller air-gap clearances, better heat dissipation in the voice coil, diaphragms with a higher fatigue characteristic, and exclusive "rim centering" construction are a tribute to UNIVERSITY design.



UNIVERSITY
LOUDSPEAKERS • INC

225 VARICK STREET
NEW YORK 14, N. Y.

Look for us at BOOTH NO. 16, RADIO PARTS and ELECTRONIC EQUIPMENT SHOW

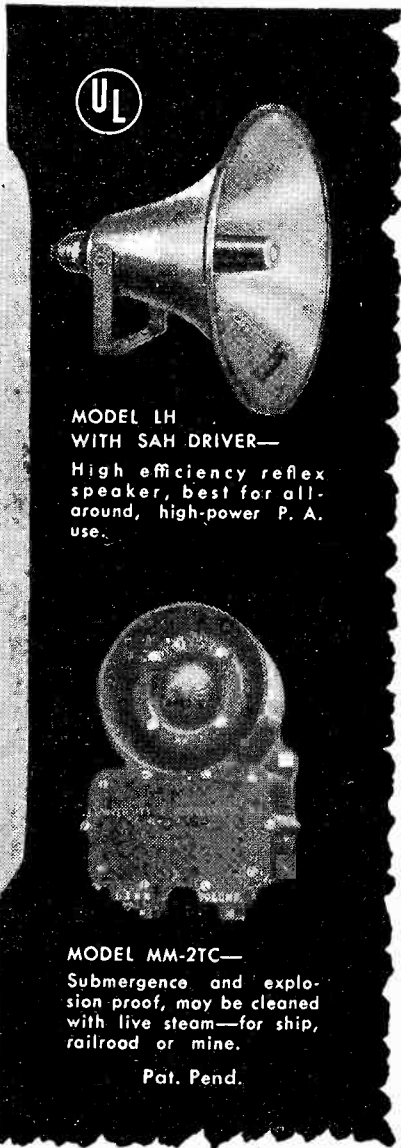

MODEL LH
WITH SAH DRIVER—

High efficiency reflex speaker, best for all-around, high-power P. A. use.

MODEL MM-2TC—

Submergence and explosion proof, may be cleaned with live steam—for ship, railroad or mine.

Pat. Pend.

was flown to St. Louis to make possible a schedule of 21 hours of programs for the first week of operation. Equipment includes an RCA microwave radio relay link and a three-bay turnstile antenna.

STANWYCK-WEBB MAGNETIC CORE CORP., Ossining, N. Y., was formed recently by John C. Webb. Production is under way, and several new iron-core developments for low-frequency applications have been completed.

PERSONNEL

HARRY E. LEROY, in the newly created position of director of manufacturing for the RCA Victor Division, will coordinate and direct manufacturing activities of RCA's ten plants throughout the country.

J. A. WALDSCHMITT has joined the firm of E. C. Page, consulting radio engineers in Washington, D. C. He was formerly assistant technical supervisor in charge of f-m and television for Bamberger Broadcasting System.

JOHN H. MILLER is vice-president and chief engineer of Weston Electrical Instrument Corp., Newark, N. J. He became assistant chief engineer of the company in 1931 and was made chief engineer in 1944.



J. H. Miller



J. J. Glauber

JOHN J. GLAUBER has been appointed chief engineer in charge of engineering and development of radio transmitting tubes at United Electronics Co., Newark, N. J. He was formerly with Federal Telecommunications Laboratories.

CHARLES M. SLACK becomes director of research for the Westinghouse Lamp Division, succeeding Harvey C. Rentschler, director of Westinghouse lamp and electronic tube research for the past 30 years, who will devote himself to complet-



ALLIED DISCS

and RECORDING EQUIPMENT



ALLIED Discs are favored by noted broadcasters and other users, for their high fidelity. Test them on your work. One of the first companies to make instantaneous recording equipment. ALLIED offers you the benefits of its seasoned skill.

Write for our New Descriptive Bulletin.

ALLIED

RECORDING PRODUCTS CO.

21-09 43d Ave., LONG ISLAND CITY 1, N. Y.

MOLDED RESISTORS

S.S. White
The "All-Weather" Resistors



TYPE 65X

Actual Size
Other types available
in the lower values

RESISTOR BULLETIN 4505
GIVES FULL DETAILS . . .

It shows illustrations of the different types of S. S. White Molded Resistors and gives details about construction, dimensions, etc. A copy, with Price List will be mailed on request. Write for it—today.

- Noiseless in operation
- Strong and durable
- Good performance in all climates

STANDARD RANGE
1000 ohms to 10 megohms

- NOISE TESTED •

At slight additional cost, resistors in the Standard Range are supplied with each resistor noise tested to the following standard: "For the complete audio frequency range, resistor shall have less noise than corresponds to a change of resistance of 1 part in 1,000,000."

HIGH VALUES
15 to 1,000,000 megohms

S.S. WHITE INDUSTRIAL

THE S. S. WHITE DENTAL MFG. CO. DIVISION
DEPT. R, 10 EAST 40TH ST., NEW YORK 18, N. Y.



FLEXIBLE SHAFTS • FLEXIBLE SHAFT TOOLS • AIRCRAFT ACCESSORIES
SMALL CUTTING AND GRINDING TOOLS • SPECIAL FORMULA RUBBERS
MOLDED RESISTORS • PLASTIC SPECIALTIES • CONTRACT PLASTICS MOLDING

One of America's AAAA Industrial Enterprises

KIRKLAND PILOT LIGHTS

ARE DISTRIBUTED NATIONALLY BY

GENERAL ELECTRIC
SUPPLY CORPORATION.

Graybar
ELECTRIC COMPANY, INC.

WESTINGHOUSE
ELECTRIC SUPPLY COMPANY

A TELEPHONE CALL TO THE NEAREST OFFICE WILL GIVE YOU PROMPT DATA, OR IF YOU PREFER THE PERSONAL ASSISTANCE OF A SALES ENGINEER. NEW AND INTERESTING VISUAL SIGNAL DEVICES NOW AVAILABLE. INVESTIGATE THE H. R. KIRKLAND CO.—MORRISTOWN, N.J.

FINE INDICATING LIGHTS SINCE 1930 OVER 300 OFFICES... COAST TO COAST

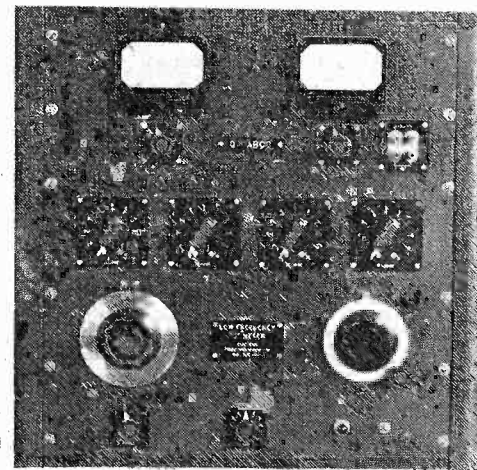

FREED Low Frequency "Q" INDICATOR

Type No. 1030. Frequency range 20 to 200,000 cycles; "Q" range from .5 to 500. "Q" of inductors measured with up to 50 volts across the coil.

INDISPENSABLE INSTRUMENT FOR MEASUREMENT OF:—

- "Q" and inductance of coils
- "Q" and capacitance of capacitors Dielectric losses and power factor of insulating materials

FREED TRANSFORMER CO., INC.
Instruments Division
72 Spring St., New York 12, N. Y.

Your Specifications are our Guide to your washer needs . . .



Design and material in washers for electrical products are important. QUADRIGA washers are made exactly to your specifications in a wide range of materials, shapes and sizes. Prompt delivery.

QUADRIGA WASHERS

All types: flat, special dimension, irregular, contour, finishing, tension, cupped and drawn, friction, dished blanks, etc. Wire Terminals. ALSO SMALL METAL STAMPINGS—ANY DESIGN. WRITE for Quadriga Catalog.

THE QUADRIGA MANUFACTURING CO.

Inc. 1894 "Half a Century"
221A West Grand Ave. Chicago 10, Ill.

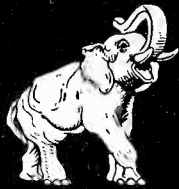

ELEPHANT BRAND PHOSPHOR BRONZE

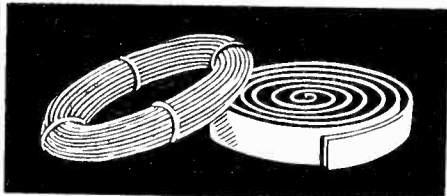

WIRE in coils for spring manufacturers; Flat wire, in coils or lengths; Tinned binding, for armature work; Straightened (round), in lengths. All wire can be supplied bright-annealed.

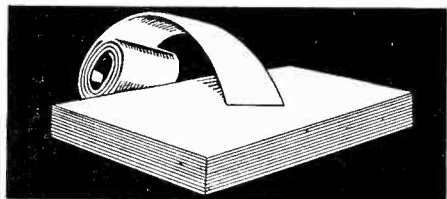

SHEETS in rolls; Slit sheet metal, tinned both sides—in various gauges and tempers covering a broad range of uses.

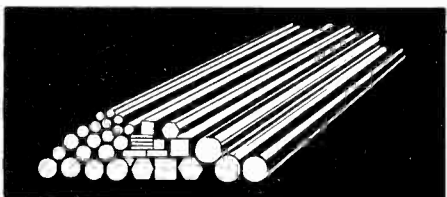

RODS up to 6" diameter, in Round, Square and Hex . . . available now for prompt delivery.

Elephant Brand Phosphor Bronze has been used by thousands of manufacturing firms in all branches of industry for nearly three-quarters of a century—Since 1874 manufacturers of nothing else but Phosphor Bronze.

THE PHOSPHOR BRONZE SMELTING CO.
2200 Washington Ave., Philadelphia 46, Pa.

Please send me a copy of your Technical Data Book

Name Title.....

Firm

Address

ing certain research projects before his approaching retirement.

VICTOR M. HARKAVY is in charge of new product development and design at Insuline Corporation of America, Long Island City, N. Y. He was previously assistant division chief at Crystal Research Laboratories, Hartford, Conn.

B. V. K. FRENCH is now director of field relations for Howard W. Sams & Co., Inc., Indianapolis, Indiana. His previous affiliation, with P. R. Mallory & Co., Inc., began in 1937. Late in 1944 he became supervisor of the Mallory research laboratory established in New York City for further development of mercury dry batteries.



B. V. K. French



L. Brendel

LYNN BRENDEL has been promoted to the post of general service manager of the Hallicrafters Co., Chicago, Ill. During the war he was radio engineer for the Chicago Signal Corps depot.

DORMAN D. ISRAEL, vice-president of Emerson Radio and Phonograph Corp., was awarded a Certificate of Appreciation by the War Department for outstanding contributions to the war effort in the research, development, and production of v-tufuzes.

WALTER A. WEISS becomes supervisor of quality control for the Radio Tube Division of Sylvania Electric Products Inc., Emporium, Pa.

H. I. ROMNES, with the Bell System for the past 18 years, became radio engineer with the American Telephone and Telegraph Co. on Dec. 1. He will head the radio section of the company's engineering division.

JOSEPH L. COLLINS is now chief engineer of Aerovox Corporation,

Passing

Radio Operators License Exams

Made Easy

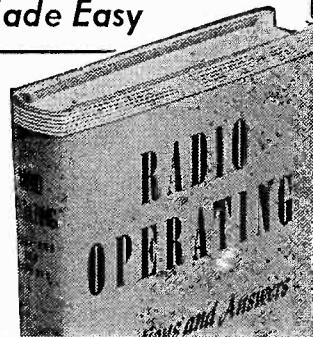

Revised 8th Edition

- Answers 1299
- Questions on radio operating
- theory
- practice
- regulations

Here's the easy way to bring all your radio training, experience and study before you in quick, direct review—make you confidently familiar with the key points of theory and practice as covered in government examinations. Use this book, as thousands of men before you have done, to get right at the facts that help you pass exams. Spend just a few minutes a day at home with this invaluable guide and successfully prepare yourself for any commercial license test.

Just Published

RADIO OPERATING

Questions and Answers

By Arthur R. Nilson, Late Chief Instructor, Nilson Radio School, and J. L. Hornung, Supervisor, Radio Electronics, Walter Hervey Junior College, N. Y.; Formerly Radio Instructor, N. Y. University. 8th Edition. 434 pages, 5x7½, 87 illustrations, \$3.50.

This new edition condenses, in question-and-answer form, theory, apparatus, circuits, operation, laws and regulations, etc.—all the information covered in the latest government exams. It gives the full correct answer to every question appearing in the Federal Communications Commission Publication, **Study Guide and Reference Material for Commercial Radio Operator License Examinations**. The answers emphasize the important key facts of each question and are classified according to the six elements upon which today's new type of professional radio license examinations are based.

This special feature makes book more helpful

To aid you in increasing efficiency, this edition now includes the American Standards Association's approved symbols for radio, telephone, telegraph and electronics circuits.

CONTENTS

- Radio Laws—Theory and Practice—Radiotelephone
- Advanced Radiotelephony — Radiotelegraph
- Advanced Radio Telegraphy — Operating Abbreviations — Rules governing commercial operators — ASA approved symbols.

Take advantage of our **FREE EXAMINATION OFFER** and get your copy today — there is no quicker, easier way to get command of the information you need to pass radio tests.

MAIL COUPON

McGraw-Hill Book Co.,
330 W. 42nd St., New York 18

Send me Nilson and Hornung's Radio Operating—Questions and Answers for 10 days' examination on approval. In 10 days I will send \$3.50 plus few cents postage or return the book postpaid. (Postage paid on cash orders.)

Name

Address

City and State.....

Company

PositionL-4-47

For Canadian price, write: Embassy Book Co.,
12 Richmond Street E., Toronto 1

→ PROBLEM

→ PROBLEM

→ PROBLEM

WHAT'S your problem
MISTER?

• Our business is solving it
—particularly if you are
searching for high grade
electronic components.

• Our story is best told in
person. We'll be glad to con-
fer with you at your conven-
ience.

• NOW IN OUR 23d YEAR

HENRY P. SEGEL
Company

Electronic Manufacturers' Representatives
and Field Engineers

143 Newbury St., Boston 16, Mass.
179 Kenyon St., Hartford 5, Conn.

PERMEABILITY TUNERS

SUPERHETERODYNE TUNERS

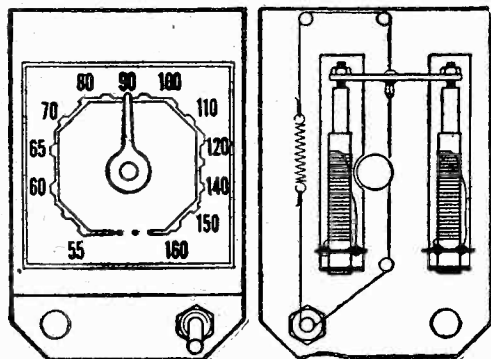

- 535 to 1660 KC Complete
- 3 Color Dial and Drive
- All units Pre-Tracked at Factory

AERMOTIVE EQUIPMENT CORP.

1632 Central St. Kansas City, Mo.
New York Office
H. BRAVERMAN
161 Washington St. N. Y. 6, N. Y.

ALNICO

permanent

MAGNETS

- Specialists in the production of highest grade Alnico Magnets.
- Production and material rigidly inspected to assure highest uniform quality.
- Castings made to order from customer's blueprints or sketches.
- Information and suggestions supplied on request.

Manufacturers of High Coercive Magnetic Alloys

10001 ERWIN AVENUE
DETROIT 5, MICHIGAN

GENERAL



MAGNETIC CORPORATION

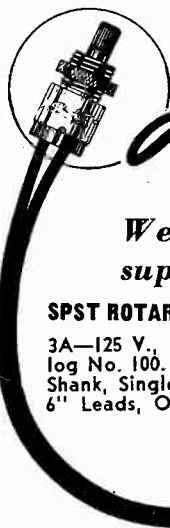

Life-Time Switch

by Slater

We think so—and so do our customers. Proving Slater's superior design and workmanship in scores of applications. They're good!

SPST ROTARY SNAP SWITCH
3A—125 V., 1A—250 V. Cata-
log No. 100. 1/8" IPS x 5/16"
Shank, Single Hole Mounting
6" Leads, One Knurled Nut.

Listed by Underwriters' Laboratories, Inc.

WRITE FOR BULLETIN
Samples Available

Slater

ELECTRIC & MFG. CO., Inc.
34-63 56TH STREET, WOODSIDE, NEW YORK

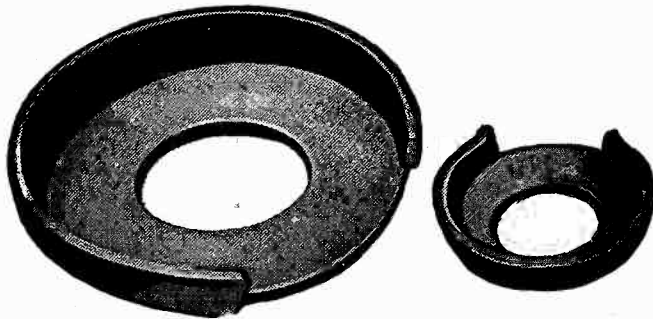

CUP WASHERS
for Binding Screws



WHITEHEAD STAMPING CO.
1691 W. Lafayette Blvd. Detroit 16, Michigan

Preferred

as a source of pre-
cision - made
WASHERS and
STAMPINGS
manufactured to
your specifications

DECADE SCALING UNIT

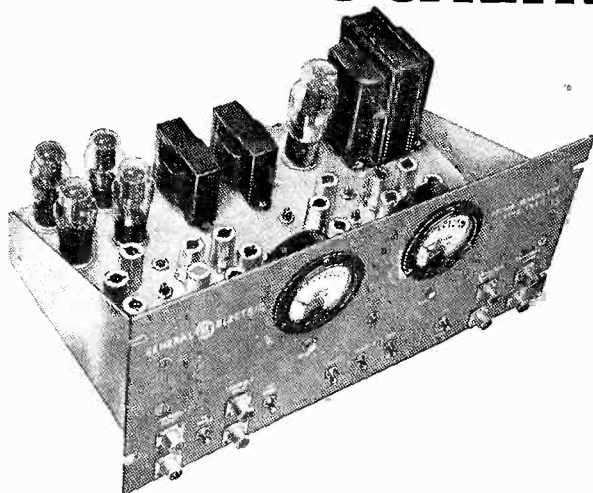

**TYPE
YYZ-1**

THIS unit offers the research laboratory a quick and effective means of counting the number of pulses from any desired source. It will prove invaluable in such studies as:

- Nuclear Research
- Radioactivity
- Mass Spectrography

In addition it will be found extremely useful:

- For Timing Purposes
- For Counting Rapidly Recurring Phenomena
- For Use in Conjunction with Calculating Machines

For additional information, write: General Electric Company, Electronics Department, E-6411, Syracuse 1, N. Y.

GENERAL  ELECTRIC

164-F1

CATHODE FOLLOWER

BASIC PATENTS

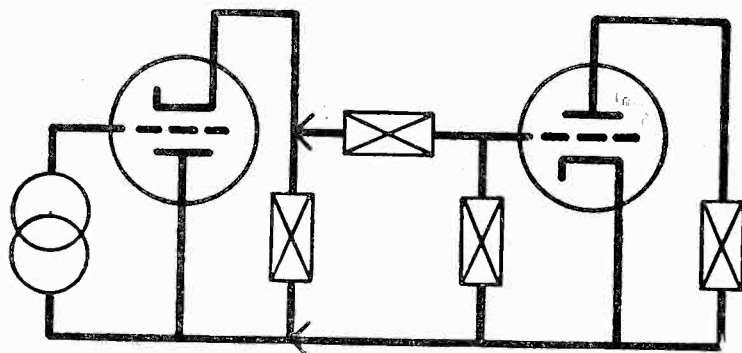

• NOTICE TO MANUFACTURERS

Licenses are now available for the use of cathode follower circuits in all types of electronic and communication apparatus.

•
**Inquiries
Are Invited**
•

REMCO ELECTRONIC, INC.

Formerly Revelation Patents Holding Co.

33 WEST 60th STREET

NEW YORK 23, NEW YORK

NEWS OF THE INDUSTRY (continued)

New Bedford, Mass. He had been head of the electrolytic engineering division since 1938, and before that was in charge of electrolytic engineering at Sprague Electric Co. for nine years.

WELLS L. DAVIS has joined the staff of Battelle Institute, Columbus, Ohio, where he will be engaged in electronic research.

ROBERT W. LARSON is now administrative assistant to the director of General Electric Research Laboratory in Schenectady, N. Y.

JOHN BALLANTYNE, president of Philco Corporation, was awarded a Certificate of Appreciation by the War Department for his wartime services in "directing the research, development, engineering, and production of highly complicated radar and associated equipment for the Signal Corps".

HARRY F. RANDOLPH becomes general plant manager of the RCA tube department, while continuing as acting plant manager of the Harrison, N. J. tube plant.

DANIEL E. NOBLE, general manager of the communications and electronics division of Motorola, has been made vice-president in charge of that division.



D. E. Noble



S. L. Parsons

STUART L. PARSONS was made chief engineer for the Tungsten and Chemicals Division of Sylvania Electric Products Inc. at Towanda, Pa. He will direct engineering and research associated with production of tungsten salts and fluorescent powders for fluorescent lamps and television viewing tubes.

SAMUEL M. THOMAS becomes assistant chief engineer of RCA Communications, Inc., having joined the organization in March 1946 after attaining the rank of Brigadier General during the war. As Chief

**REVERSIBLE
GEARED MOTOR**

3 1/2" x 1 3/8"

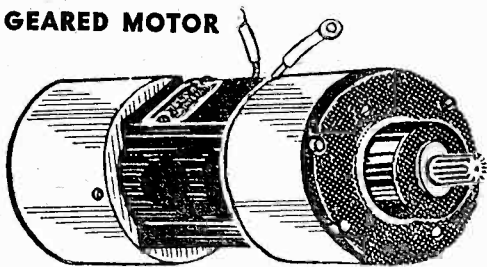

Operates on Flashlight batteries, speed depending on the voltage. Fairly strong on 6 volts, full power and speed on 27 volts. Designed to be used in bombsights, automatic pilots, etc. Two types, 145 to 250 RPM. Either speed a bargain at **\$5.00**

**ALNICO FIELD
MOTOR**

2" x 1" x 1"
with
FLY WHEEL
GOVERNOR
10000 R.P.M.

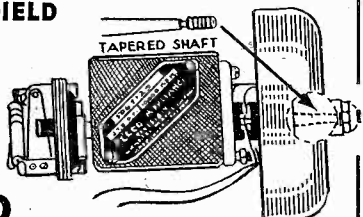

\$3.50

**ALNICO MAGNETS
SMALL HORSESHOES**

5/8 x 5/8 x 3/4



2 for . . . \$1.00

EST
1923

BLAN

EST
1923

Experimenters and Inventors Supplies

64 Dey St., New York 7, N. Y.

**Theory and Application of
RADIO-FREQUENCY
HEATING**

By George H. Brown, Ph.D., E.E. Fellow, I.R.E. Member, A.I.E.E. Research Engineer, RCA Laboratories, Princeton, N. J. Section head in charge of radio-frequency heating and antenna research.

and

Cyril N. Hoyler, M.S. Senior Member, I.R.E. Member technical staff, RCA Laboratories, Princeton, N. J. Formerly Professor and Head of Physics Department, Moravian College.

and

Rudolph A. Bierwirth, M.S. Member, I.R.E. Chief Engineer, Sound Incorporated, Chicago. Formerly Research Engineer, RCA Laboratories.

This important new book clearly describes and fully explains how radio-frequency heating is used in metallurgy, bacteriology, chemistry and electrical engineering—in the processing of plastics, plywood, furniture, textiles, pharmaceutical preparations, food, rubber, etc.—in the case-hardening of steel, the bonding of thermoplastic sheets, the drying of penicillin, the determination of the properties of electrical conductors and chemical compounds—and in a host of other manufacturing operations and scientific investigations.

All the necessary formulas, factors and methods, are presented in convenient graphs, tables and alignment charts—instantly available for direct use in solving actual problems. From basic principles to actual applications, this book is a logically-developed, complete treatise on radio-frequency heating.

EXAMINE THIS GREAT BOOK FREE

MAIL THIS COUPON

D. VAN NOSTRAND COMPANY, INC.
250 Fourth Avenue, New York 3, N.Y.
Please send me a copy of THEORY AND APPLICATION OF RADIO-FREQUENCY HEATING for examination. Within 10 days I will return the book to you or send you \$8.50 plus a few cents postage.

Name
Address
City Zone State
Elec.-April 1947

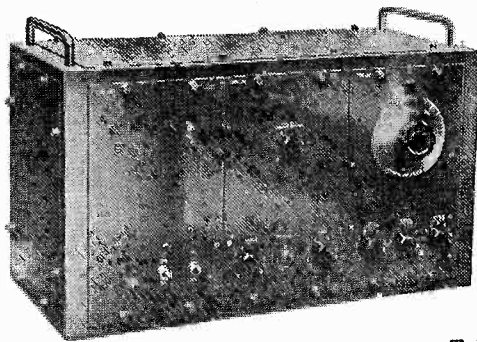

**PUBLIC
ADDRESS**

by

ACOUSTICAL

for the very best in

**REPRODUCTION • DESIGN
WORKMANSHIP • SERVICE**

We will gladly send you full details and specifications of the full range of ACOUSTICAL P. A. Equipment on request.



MANUFACTURING CO., LTD.
HUNTINGDON • ENGLAND
TELEPHONE: HUNTINGDON 361

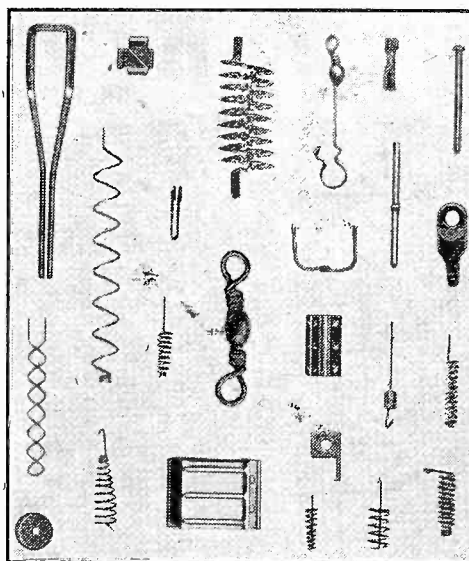

SMALL PARTS

Filaments, anodes, supports, springs, etc. for electronic tubes. Small wire and flat metal formed parts to your prints for your assemblies. Double pointed pins. Wire straightened and cut diameter up to 1/8-inch. Any length up to 12 feet.

LUXON fishing tackle accessories.

Inquiries will receive prompt attention.

**ART WIRE AND
STAMPING CO.**

227 High St.

Newark 2, N. J.

LAMINATED PLASTICS

Phenol Fibre . . .

Water-, oil-, and chemical-resisting sheets of high dielectric strength. Supplied in black and natural color. Standard sheets approximately 49 x 49 inches. Thicknesses from .010 to 9 inches. Rods and tubes.

Vulcanized Fibre

Remarkably uniform, high-grade, hard fibre in sheets 56 x 90 inches to save waste in cutting. Smaller sheets if desired. Also in standard-size rods.

FABRICATED PARTS • TAYLOR INSULATION • SILENT GEAR STOCK

We're ready whenever you are. Send blueprints.

TAYLOR FIBRE COMPANY Norristown, Pennsylvania

Pacific Coast Plant: La Verne, California • Offices in Principal Cities

LOOKING FOR

Information* on

*We mean up-to-the-minute data, with all the necessary mechanical, physical and electrical characteristics. Then send for . . .

ITC BULLETINS on any or all of the three ITC Products listed. They'll give you the type of information you want—concise, engineeringly correct and the necessary data by which you can quickly judge if they fulfill your needs. Send for them today and make them a part of your permanent data files.

**SHOCK PROOF
INSULATION
BREAK DOWN
TEST SETS**

TRANSFORMERS

**INCREMENTAL
INDUCTANCE
BRIDGES**



THE TRADE-MARK THAT

Guarantees Performance

INDUSTRIAL TRANSFORMER

C O R P O R A T I O N

ELECTRONICS DIVISION

2540 Belmont Ave.

New York 58, N. Y.

TWIN POWER SUPPLY

**Electronically
Regulated for
precise
measurements**

Two independent sources of continuously variable D.C. are combined in this one convenient unit. Its double utility makes it a most useful instrument for laboratory and test station work. Three power ranges are instantly selected with a rotary switch:

175-350 V. at 0-60 Ma., terminated and controlled independently, may be used to supply 2 separate requirements.
0-175 V. at 0-60 Ma. for single supply.
175-350 V. at 0-120 Ma. for single supply.

In addition, a convenient 6.3 V.A.C. filament source is provided. The normally floating system is properly terminated for external grounding when desired. Adequately protected against overloads.

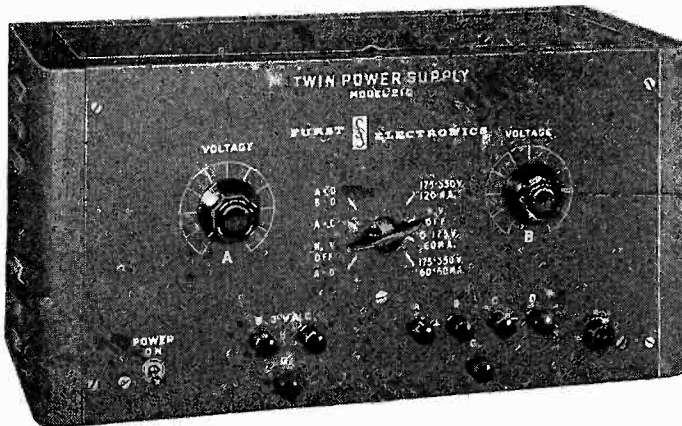

- Output voltage variation less than 1% with change from 0 to full load.
- Output voltage variation less than 1 V. with change from 105 to 125 A.C. Line Voltage.
- Output ripple and noise less than .025 V.

Twin Power Supply Model 210 Complete \$115.00 F.O.B. Chicago
Dimensions: 16" x 8" x 8" Shipping Wt. 35 lbs.
(Other types for your special requirements)

SOME TERRITORIES STILL AVAILABLE FOR REPRESENTATIVES

FURST ELECTRONICS

806 W. NORTH AVENUE, CHICAGO 22, ILLINOIS



NEWS OF THE INDUSTRY

(continued)

of Staff to the Commanding General of the Persian Gulf Command, he developed a communications system that supported movement of military and lend-lease supplies to Russia through the Persian Corridor.

GEORGE H. PHELPS of Westinghouse Electric Corp. is RMA representative in connection with formation of the Radio Technical Commission for Marine, a new government-industry agency.

FRED M. ANDREWS has been named chief engineer of stations WROL and WROL-FM in Knoxville, Tennessee. During the war he headed a Philco group preparing Signal Corps radar equipment training manuals at Fort Monmouth.

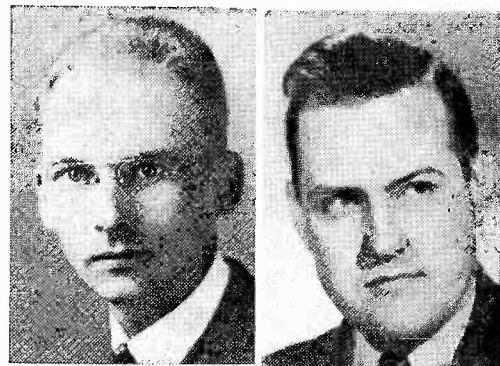

F. M. Andrews L. L. Helterline, Jr.

LEO L. HELTERLINE, Jr. is chief engineer for Sorensen & Co., Inc., Stamford, Conn., supervising design and development of their lines of voltage regulators, transformers, and special electronic equipment.

ALBERT C. GABLE, with General Electric Co. since 1929, becomes assistant engineer of the Tube Division in their Electronics Department at Schenectady, N. Y.

RALPH A. GALBRAITH is now professor of electrical engineering at Syracuse University and chairman of the Department. He comes from Georgia School of Technology, where he held a similar position since March 1946. The previous two years were spent as a staff member of MIT Radar School, where he was contributing author to "Principles of Radar".

LEE DE FOREST received the Edison medal at the annual AIEE winter meeting in New York City for "pioneering achievement in radio and for the invention of the grid-controlled vacuum tube with its profound technical and social consequence".

**MICRODIMENSIONAL
WIRE & RIBBON
FOR VACUUM TUBES**

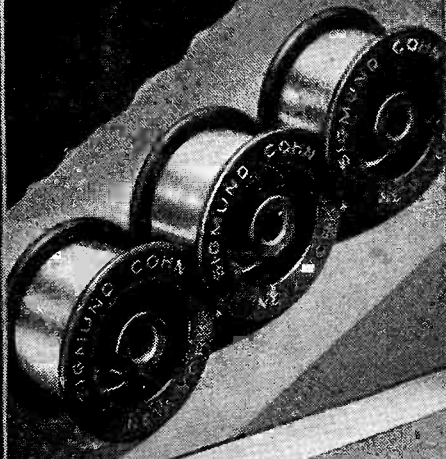

Wires drawn to .0004" diameter.

Ribbon rolled to .0001" thickness.

Special Alloys for individual requirements.

WRITE for list of stock alloys.

SIGMUND COHN & CO.

44 GOLD ST. NEW YORK

SINCE



1901

EAGLE TIMERS

for Controlling
Industrial Processes

REPEAT CYCLE
Use where ON-OFF operation is continuously repeated. The ON time and OFF time are each adjustable on the dial. (FLEX-OPULSE)

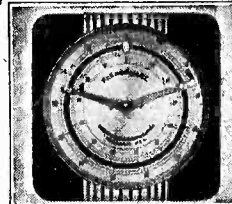

COUNTER

Use for limiting a process to an exact number of operations. The counter contact opens after 1 to 400 electrical impulses as selected on dial. Automatic spring reset. (MICROFLEX COUNTER)

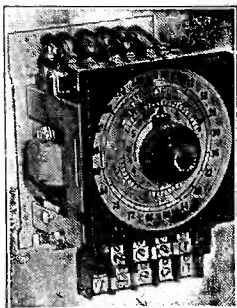

MICROMETER DIAL

Provides exceptional timing accuracy where a circuit is to close or open with a time delay. Timing adjustable over wide range. (MICROFLEX TIMER)

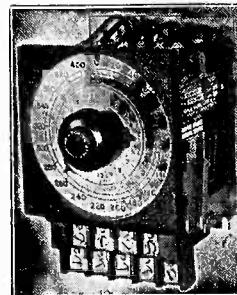

MULTIPLE CIRCUIT —ADJUSTABLE

Use where several circuits are to close in a predetermined sequence. Time of closing and opening each circuit is adjustable. (MULTIFLEX TIMER)

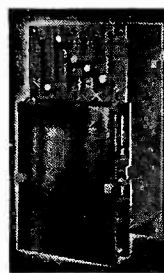

To reduce costs and improve quality of your products by automatic TIME-COUNT control . . .

- ★ Write for catalogue Bul. 291
- ★ Send details of your control problems to Eagle for recommendations
- ★ Consult Eagle representatives in principal cities



EAGLE
Signal Corp.
MOLINE ILLINOIS



A number of attractive positions are open to qualified development and design engineers in many product lines of which a few are:

Theater Sound and Projection Equipment

Broadcast Transmitters

Industrial Electronics

Scientific Instruments

Television Transmitters

Communication Equipment

Commercial Sound Equipment

Test and Measuring Equipment

Government Radiation Equipment

Aviation Communication and Navigation Equipment

Write to

National Recruiting Office

RCA Victor Division

Camden

New Jersey

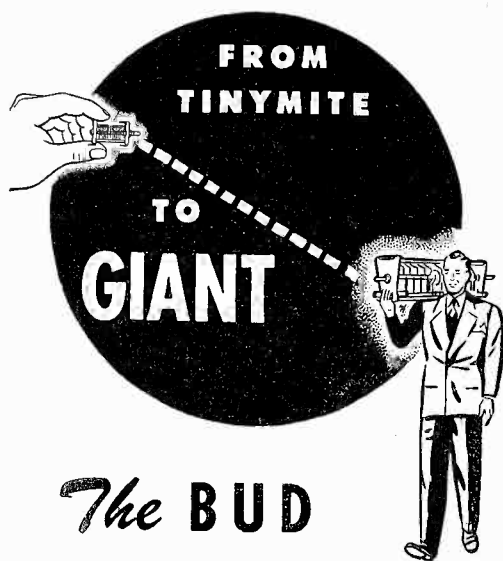

The **BUD**
CONDENSER LINE
covers all your needs
for quality condensers

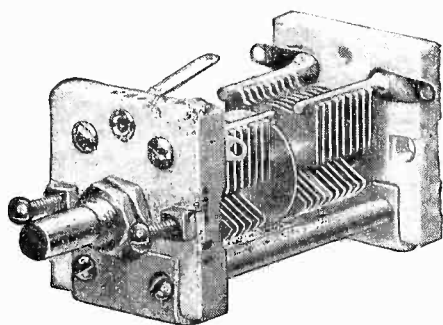

The TINY MITE condensers include a complete line of padders and single and dual section tuning condensers. When space or weight are limiting factors . . . these condensers will "fit the bill".

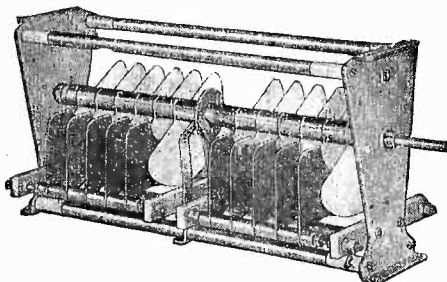

Modern design, plus precision production methods makes BUD GIANT transmitter condensers the choice of critical engineers for use in such applications as broadcast transmitters, high-powered trans-oceanic communication equipment and many other highly specialized electronic devices.

And this isn't all! Have your local distributor show you the complete BUD Condenser Line and see for yourself its many exclusive advantages!

**BUD Can Supply
All Your Needs! . . .**

. . . with the latest types of equipment including: condensers—chokes—coils—insulators—plugs—jacks—switches—dials—test leads—jewel lights and a complete line of ultra-modern cabinets and chassis.



BUD RADIO, INC.
CLEVELAND 3, OHIO

NEW BOOKS

Drafting for Electronics

By L. F. B. CARINI. *McGraw-Hill Book Co., Inc., New York, 1946, 211 pages, \$2.50.*

WRITTEN for the draftsman and for trade-school students specializing in electronics, this book presents mechanical aspects of schematic circuit layout and drawing. It also includes chapters on such general drafting techniques as use of instruments and lettering. The book is significant in that its appearance on the market recognizes the special aspects of drawing electronic circuits and emphasizes need for universal use of ASA standard symbols. As a guide in teaching drafting, a bibliography of visual aids is appended.—F.R.

Cathode Ray Oscillograph in Industrial Electronics

By HAROLD W. RANNEY and MALACHI WHELAN. *Published by New York State Vocational and Practical Arts Association; distributed by Delmar Publ., Inc., 49 Sheridan Ave., Albany 6, N. Y., 96 pages, \$3.00.*

PHOTOGRAPHS of waveshapes obtained across various parts of rectifiers are presented with descriptive text explaining the significance of the waveforms. Here is a comprehensive and utilitarian reference for servicing rectifiers with an oscilloscope—a technique that, as the book makes clear, is very quick and simple.—F.R.

Electrical Transmission in the Steady State

By PAUL J. SELGIN, *McGraw-Hill Book Co., Inc., New York, N. Y., 1946, 427 pages, \$5.00.*

WRITTEN AS A REVIEW for college graduates who find themselves in need of refreshing their appreciation of the underlying concepts of electrical transmission, this mathematical presentation of circuit analysis probes the fundamentals of circuit theory. The idea of an engineering refresher is novel and attracted this reviewer to the book with a predisposition to rate it highly; the book sustained the anticipation.

The presentation serves both to review the electrical concepts of lumped and distributed circuits

(for the most part communication) in the steady state and to review the algebra, calculus, and—to a lesser extent—the vector analysis wherewith these concepts are manipulated. The book will appeal more to the basic engineer than to the application one. Many of the angles of approach to the subject will arouse one from his lethargy of conventional thinking with the result that old accepted ideas will take on new depth and clarity.

—F. R.

Applied Mathematics for Engineers and Physicists

By LOUIS A. PIPES, *Research and Electronics Division, Hughes Aircraft Co. McGraw-Hill Book Co., Inc., New York, 1946, 618 pages, \$5.50.*

IN CONTENT this book is much like the several other excellent texts on applied mathematics. In presentation, however, it stresses application to engineering more than other similar books do, and—of particular interest to this audience—uses electronic problems frequently as illustrative material.—F.R.

Trigonometry Refresher for Technical Men

By A. ALBERT KLAUF, *Civil Engineer, Board of Water Supply, City of New York. McGraw-Hill Book Co., Inc., 1946, 629 pages, \$5.00.*

FOR THOSE who sometimes check fundamental trigonometric functions by recalling that the sine of a is the ratio of opposite to adjacent side, the author's concept of the matter falls unfamiliarly, but pleasantly, on the senses. His angle has three parts; initial line, terminal line and vertex. The hypotenuse is represented by a "distance" laid off on the terminal line, the adjacent side by a "shadow" cast by the assumed distance upon the initial line, while the opposite side is a "perpendicular" from the distance to the shadow. This concept, and the question-answer technique, are a key to the modern and practical tone of the text.

Spherical trigonometry is presented briefly with emphasis on its use in air and sea navigation, carrying through the basic philosophy of the book—trigonometry as an aid to live technology.—A. A. MCK.

CONTACTS

FOR THE FIELD OF ELECTRONICS



FINE RIBBONS OF TUNGSTEN and MOLYBDENUM
Quality and accuracy in our fabrication of Tungsten & Molybdenum Ribbons have characterized our service to the Electronic industry.
A development of
H. CROSS Co.
15 Beekman St., New York 7, N. Y.

RADIO KNOBS **IMMEDIATE DELIVERY**



No. 1100 No. 1105 No. 1109
No. 1110

LARGE QUANTITIES for Manufacturers
Now available—variety of bakelite knobs in large quantities—set screw, knurl, or spring type—write for samples and quotations.
Write today for catalog of 3,000 electronic products.
GENERAL CEMENT MFG. CO.
Rockford, Illinois, U. S. A.

Kahle

ELECTRON TUBE MACHINERY OF ALL TYPES STANDARD AND SPECIAL DESIGN



We specialize in Equipment and Methods for the Manufacture of
RADIO TUBES
CATHODE RAY TUBES
FLUORESCENT LAMPS
INCANDESCENT LAMPS
NEON TUBES
PHOTO CELLS
X-RAY TUBES
GLASS PRODUCTS

Production or Laboratory Basis

Kahle ENGINEERING CO.
1309 SEVENTH STREET
NORTH BERGEN, N. J., U. S. A.

WE manufacture a complete line of equipment



SPOT WELDERS, electric from ¼ to 50 KVA
TRANSFORMERS, special and standard types
INCANDESCENT LAMP manufacturing equipment
FLUORESCENT TUBE MAKING EQUIPMENT
ELECTRONIC EQUIPMENT, vacuum pumps, etc.
WET GLASS SLICING and cutting machines for laboratory use
GENERAL GLASS working machines and burners
COLLEGE GLASS working units for students and laboratory
EISLER ENGINEERING CO.
731 So. 13th St. (near Avon Ave.) Newark, New Jersey

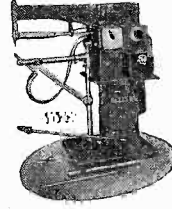

AC ARC WELDERS from 100 to 400 Amps

High Speed Production Of Quality
R. F. Coils and Sub-Assemblies,
For Discriminating Manufacturers



Clippard INSTRUMENT LABORATORY, INC.
1125 Bank Street, Cincinnati 14, Ohio

This
CONTACTS
Section

supplements other advertising in this issue with these additional announcements of products essential to efficient and economical operation and maintenance. Make a habit of checking this page, each issue.

Classified Advertising Division
ELECTRONICS
330 W. 42nd St., New York 18, N. Y.

PRINTED TAPE
— For "Parts" Marking —
TOPFLIGHT TOOL CO.
Huber Bldg., York, Pa.

MICROMETER FREQUENCY METER for Checking Transmitters from 100 Kc to 175 Mc. within 0.01 per cent

LAMPKIN LABORATORIES
Bradenton, Fla. U. S. A.

FILMGRAPH PAT'D
Conference Recorders

UNINTERRUPTED Longtime (up to 12 hours) Conference & Telephone Recordings on Safety Film Models for Dictation "TALKIES"
MILES REPRODUCER CO., INC. 812 BROADWAY, N.Y.3

ECONOMICAL PERMANENT INSTANTANEOUS PLAY-BACK

PRECISION MACHINE ENGRAVING ON METALS & PLASTICS

Speedy Service and Excellent Work on small or Large Orders, on Dials, Name Plates, Panels, Gauges, Instruments, etc.
SEND PRINTS FOR QUOTATIONS TO
ALPHA ENGRAVING COMPANY
87-08 97th St. Woodhaven 21, N. Y.

If this or other advertising does not supply the information concerning products or services wanted, please write:

ELECTRONICS



REX RHEOSTATS

REX RHEOSTAT COMPANY, BALDWIN, L. I., N. Y.

PROTECTED & UNPROTECTED
RHEOSTATS
WITH LUBRICATED CONTACTS
ROTARY DRIVE RHEOSTATS
WITHOUT BACK LASH
PROTECTED & UNPROTECTED
ADJUSTABLE RESISTORS
UP TO 1000 WATT
PROMPT SHIPMENTS

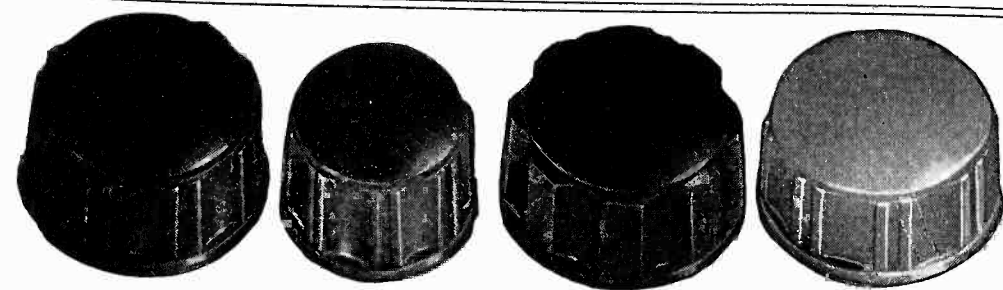

Stock Molded KNOBS

For Every Requirement

ROGAN offers a large selection of plastic Knobs from stock molds. These are supplied without tool charge. Available in various sizes, shapes and colors. Smartly styled, quality made, ideally suited for a wide range of applications. Markings can be branded in "deep relief" on blank parts, as desired. Whatever your knob requirements may be, Rogan is equipped to serve you faster, better, more economically. In addition, Rogan offers a complete source of compression molded parts of all types. Write for complete details NOW!

ROGAN BROTHERS

2003 S. MICHIGAN AVE. CHICAGO 16, ILLINOIS
Compression Molders and Branders of Plastics



Backtalk

This department is operated as an open forum where our readers may discuss problems of the electronics industry or comment upon articles which ELECTRONICS has published.

Ultrasonics

Dear Editor:

I AM glad to applaud ELECTRONICS' decision to use "supersonics" for velocities and "ultrasonics" for high frequencies and will probably not be the first to point out the inconsistencies of usage exhibited in the Beeper paper in the same issue by Walker and Kendig.

I am in a peculiarly vulnerable position to complain about Walker's usage of supersonic to mean ultrasonic since it was only during the completion report sweep-up era of HUSL that we settled down to agree on ultrasonics as a designation for the high-frequency sound field.

F. V. HUNT
Cruft Laboratory
Harvard University
Cambridge, Mass.

R-F Heating Data

Gentlemen:

ON PAGE 126 of January ELECTRONICS, you have published two tables giving electronic heating requirements.

Please accept my thanks for the information which you have given in these tables as it is going to save our staff a great deal of time and energy.

We are using high-frequency current to heat steel of various cross sections and it would be a very great help to us if you could publish a table showing the relationship between efficient frequency and cross section of steel.

G. J. MANSON
Acting Assistant Chief Engineer
Canadian Arsenals Limited
Ottawa, Canada

ACCORDING TO A RECENT RMA definition, a live part involving a potential of more than 1,000 volts is considered to be accessible if it is so located that contact with the part can be made by a ten-inch straight rod $\frac{1}{8}$ inch in diameter, inserted through the opening.

MORE, BETTER JOBS PER DOLLAR.

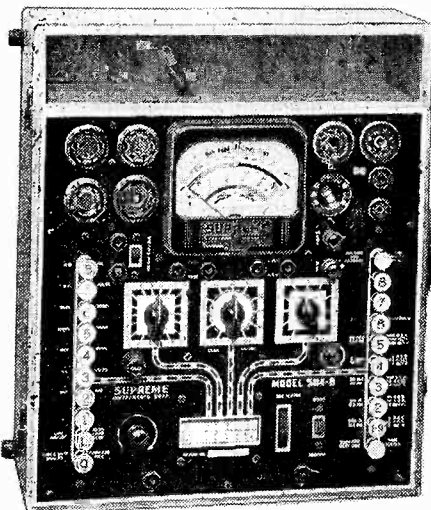

SUPREME 504-B TUBE AND SET TESTER—

the portable lab that gives you everything.

ASK YOUR SUPREME
JOBBER FOR A FREE
DEMONSTRATION

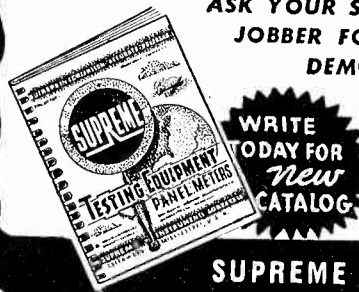

WRITE
TODAY FOR
New
CATALOG

EXPORT DEPT.: The American Steel Export Co., Inc.
347 Madison Ave., New York 17, N. Y., U. S. A.

SUPREME

SUPREME INSTRUMENTS CORP., Greenwood, Miss., U. S. A.

HERE'S WHY AND HOW

- METER—large 4-inch square-face meter, 500 microampere.
- SPEED—push-button operated.
- FLEXIBLE—simple, yet Universal Floating Filaments feature insures against obsolescence.
- SIMPLICITY—roll chart carries full data for tube setting. No roaming test leads when using multi-meter—only push a button.

SPECIFICATIONS

DC VOLTS—1000 Ohms per volt: 0-5-25
100-250-500-1000-2500.
AC VOLTS—0-5-10-50-250-1000.
OUTPUT VOLTS—0-5-10-50-250-1000.
OHMMETER—0-200-2000-20,000 Ohms.
0-2-20 Megohms.

Condenser Check:

Electrolytics checked on English reading scale at rated voltages of 25-50-100-200-250-300-450 volts.

Battery Test:

Check dry portable "A" and "B" batteries under load.

PROFESSIONAL SERVICES

H. RUSSELL BROWNELL

Consulting Engineer

Specializing in Measurements & Testing
Instruments & Techniques - Electrical - Elec-
tronic - Magnetic.

188 West 4th St. New York 14, N. Y.
Chelsea 2-4208

ELM LABORATORIES

ELECTRONIC-MECHANICAL
RESEARCH & DESIGN

Patented ELM Developments include
PREGRAME Automatic Radio Program Tuner,
Famous "Gerty" Direction Finder Loop, Sealed
Xtal Holder, Home Receiver Designs.
20 South Broadway Dobbs Ferry, New York
Phone Dobbs Ferry 4058

JOSEPH RAZEK, Ph.D.

Consulting Physicist

Electric and Mechanical Engineering Problems
Instruments and Control Devices Electronics
Specialists in Colorimetry, Spectrophotometry and
Industrial Color Control

Laboratory and Shop Facilities
202 Darby Road Lanserch, Pa.
Phone Hilltop 6910

EDWARD J. CONTENT

Acoustical Consultant

and

Audie Systems Engineering, FM, Standard Broad-
cast and Television Studio Design.

Roxbury Road Stamford 3-7459
Stamford, Conn.

PAUL E. GERST & CO.

CONSULTING ENGINEER

Specialists in
Electrical Product Design

El. Machinery, Apparatus & Applications
El. Appliances, Hi-Frequencies Apparatus

Electronics, Radio Communications
205 W. Wacker Dr. Chicago 6, Ill.

ARTHUR J. SANIAL

Consulting Engineer

Loudspeakers and Allied Devices

168-14 32 Ave. Flushing, N. Y.

DONALDSON ELECTRONICS LABORATORY

Research and Development

Shoran Radio Survey Consultant
Custom Built 'Scoopes - Trick Circuits
Microsecond Sweeps - Microwave Systems
Industrial Applications

P.O. Box 1486 San Antonio, Texas

C. M. HATHAWAY

Consulting Engineer

Research and Development
Product Designs

Tool & Methods, Engineering
Pilot Manufacturing

1315 S. Clarkson St. Denver 10, Colorado

RAYMOND M. WILMOTTE INC.

A Complete Engineering Service
for the

Application of Electronics to Industry
Consultation Design Construction
236 West 55 Street 1713 Kalorama Road N. W.
New York 19, N. Y. Washington, 5, D. C.

STANLEY D. EILENBERGER

Consulting Engineer

INDUSTRIAL ELECTRONICS

Design—Development—Models
Complete Laboratory and Shop Facilities

6309-13—27th Ave.
Kenosha, Wis. Telephone 2-4213

INDUSTRIAL DEVELOPMENT ENGINEERING ASSOCIATES

Engineering Consultants

Electronic Control, Motion Picture &
Sound Equipment

Development—Design—Models
4125 E. 10th St. Indianapolis, Ind.

YARDENY ENGINEERING CO.

Remote Controls (Wires and Wireless)
Automatic Devices

Electronic • Electrical • Mechanical
Consultation • Designing • Manufacturing
Licensing

105 Chambers Street New York, N. Y.
Worth 2-3534, 3535

ELECTRONEERS

Electronic Consultants

Industrial - Communications - Medical
Write or phone for preliminary survey without
charge.

489 Fifth Ave. New York 17, N. Y.
Murray Hill 2-2492

ALBERT PREISMAN

Consulting Engineer

Television, pulse Techniques, Video
Amplifiers, Phasing Networks,
Industrial Applications

Affiliated with
MANAGEMENT-TRAINING ASSOCIATES
3308-14th St., N.W. Washington 10, D. C.

PAUL D. ZOTTU

Consulting Engineer

INDUSTRIAL ELECTRONICS

High Frequency Dielectric and Induction Heating
Applications, Equipment Selection, Equipment and
component Design, Development, Models.

272 Centre St. Newton, Mass.
BIG-9240

Rate:
UNDISPLAYED

90¢ a line. Minimum 4
lines. To figure advance
payment count 6 average
words as a line. Address
c/o publication is 10 words.
Positions Wanted ads half
rate.

SEARCHLIGHT SECTION

(Classified Advertising)

**EMPLOYMENT : " OPPORTUNITIES " : EQUIPMENT
BUSINESS : USED OR RESALE**

NEW ADVERTISEMENTS received by April 11th will appear in the May issue, subject to space limitations

Rate:
DISPLAYED

\$9.00 per inch per inser-
tion. Contract rates on re-
quest. Individual spaces
with border rules. 30 inches
to a page.

POSITIONS VACANT

SALES ENGINEER—For factory sales office
to work under assistant Sales Manager—In-
dustrial. Handle technical correspondence,
quotations, orders expediting. Needs good
broadcast and industrial electronic engineering
background. B.S. degree desirable but not
mandatory. Must have sales experience. Write
describing experience and salary expected.
E. F. Johnson Co., Waseca, Minnesota, Atten-
tion: Wally B. Swank.

PUBLICITY AND Sales Production Man—
For factory sales office to work under Sales
Manager. Correspond with distributors and
amateurs; work on new applications of com-
pany products; write publicity articles; etc.
Must be licensed, experienced Radio Amateur
with sales experience. Write describing experi-
ence and salary expected. E. F. Johnson Co.,
Waseca, Minnesota, Attention: Wally B.
Swank.

RADIO ENGINEER with experience in design
of microwave components required by Re-
search Department of Galvin Manufacturing
Corporation, 4545 W. Augusta Boulevard, Chi-
cago, Illinois, Write attention of D. E. Noble.

PHYSICIST WITH vacuum tube laboratory
experience on photo surfaces and phosphors.
Important project in small company. Perma-
nent position, state experience. P-320, Elec-
tronics, 330 W. 42nd St., New York 18, N. Y.

(Continued on page 284)

FACTORY ENGINEER

We have an opening in our factory engineering
division for an outstanding man. This position
requires experienced background of at least 5 years
engineering work on factory problems relating to
receiving tubes manufacture. An engineering degree
would be helpful but the primary requirements of
the position are the experience and the ability to
successfully solve every-day problems encountered
in the manufacture of receiving tubes.

Apply by letter to Personnel Dept.

**NATIONAL UNION RADIO
CORPORATION**

Lansdale, Pa.

**Additional
EMPLOYMENT
ADVERTISING
on pages 284 & 285**

MATURE MOTOR DEVELOPMENT ENGINEER

Our medium-sized Company has an
opening for a thoroughly experienced
Design Engineer on sub-fractional A.C.
motors. It is essential that this man
have a minimum of 5 to 8 years ex-
perience directly in this field with well
known large quantity producers and
that he be able to handle both the
mechanical and electrical development
of sub-fractionals.

We are an established manufacturer
in the small motor field and are inter-
ested only in a capable and experi-
enced engineer. If you have the proper
background, write us in confidence.

The arrangements will be attractive
for the man who can meet our require-
ments.

P-300, Electronics
330 West 42 St., New York 18, N. Y.



(Continued from page 283)

SELLING OPPORTUNITIES OFFERED

SALES ENGINEER to sell electronic test equipment. Should have background of electronics plus knowledge of manufacturing methods. Small company with great opportunity for right man. State qualifications. SW-319, Electronics, 330 W. 42nd St., New York 18, N. Y.

WANTED SALES Representative for manufacturer of electronic coils—developed and made to specifications of user. RW-321, Electronics, 330 W. 42nd St., New York 18, N. Y.

EMPLOYMENT SERVICES

SALARIED POSITIONS \$2,500 - \$25,000. This thoroughly organized confidential service of 37 years' recognized standing and reputation carries on preliminary negotiations for supervisory, technical and executive positions of the calibre indicated, through a procedure individualized to each client's requirements. Retaining fee protected by refund provision. Identity covered and present position protected. Send only name and address for details. R. W. Bixby, Inc., 278 Dun Bldg., Buffalo 2, N. Y.

EXECUTIVES \$3,000-\$25,000. This reliable service, established 1927, is geared to needs of high grade men who seek a change of connection under conditions assuring, if employed, full protection to present position. Send name and address only for details. Personal consultation invited. Jira Thayer Jennings, Dept. E, 109 Church Street, New Haven, Conn.

POSITIONS WANTED

ENGINEER presently employed as supervisor of test equipment design section for large manufacturer desires position with smaller progressive organization actively planning production of television receivers. Have successfully organized both prewar and postwar television receiver production test programs. Familiar with preproduction model analysis, test process, establishment and standards, production methods of assembly and test, equipment costs, quality and reject control. Age 35. Position must carry direct responsibility for setting up and initiating production—with commensurate salary. PW-297, Electronics, 330 W. 42nd St., New York 18, N. Y.

GRADUATE ELECTRICAL Engineer desires position as specialist in audio frequency devices and controls. Highly interested in Cinemaphotography and associated sound work. Can offer some valuable ideas and improvements. Willing to travel anywhere in the U. S. or abroad. Position must carry direct responsibility. PW-322, Electronics, 330 W. 42nd St., New York 18, N. Y.

INTERESTED IN Telemetering? Electronics Engineer (with background of seven years experience in design, development, manufacture, and field service of test equipment and special electronic apparatus) is currently conducting advanced development program on telemetering project for aircraft flight research and guided missile work. Desires responsible position, with commensurate salary, with well established concern. PW-323, Electronics, 330 W. 42nd St., New York 18, N. Y.

ELECTRICAL ENGINEER, graduated 1939 from Swiss Fed. Inst. of Technology (equivalent to M.S.) desires position in Electronics or Acoustics. 7 years experience in communication techniques and acoustics. Several publications. First papers. PW-326, Electronics, 330 West 42nd St., New York 18, N. Y.

BUSINESS OPPORTUNITY

Coil Winding Plant, modern machinery, requires capital for expansion or will consider selling outright. Location 30 miles from Philadelphia. BO-324, Electronics, 330 W. 42nd St., New York 18, N. Y.

MR. MANUFACTURER

Can you use a sales engineer with wide acquaintance throughout Midwest industries? Broad acquaintance in radio, electronics, allied fields. Plenty on the ball. Much to offer right company. Married, established but young, adaptable. Available shortly. Minimum \$6,000. Reply in strict confidence.

PW-325, Electronics
520 North Michigan Ave., Chicago 11, Ill.

PRODUCTION COORDINATOR

PRODUCTION MANAGER WITH EXPERIENCE IN ELECTRONIC ENGINEERING, QUALITY CONTROL, SALES, ESTIMATING, AND PROCESS. DESIRES POSITION AS PRODUCTION COORDINATOR OR MANAGER IN PROGRESSIVE COMPANY.

PW-315, Electronics
330 West 42nd St., New York 18, N. Y.

ATTENTION ENGINEERS

Experienced engineers with Bachelor's, Master's, or Doctor's degrees in Electrical Engineering, Communications, Radio, Physics, Mathematics. At least two years experience in design and development of radar and television systems, electronics navigational systems, automatic computers, servomechanisms, etc., required. Specialists in High Frequency transmitters, receivers, antennas, aircraft electronic components particularly desired. Starting salary commensurate with experience. Exceptional opportunity for the right men. Write

McDONNELL AIRCRAFT CORPORATION

Lambert—St. Louis Municipal Airport, Box 516, St. Louis (21) Missouri

Engineers

Broadcast Radio receiver Project Engineers, Television receiver Project Engineers and Mechanical Engineers experienced in broadcast receiver engineering methods. Excellent opportunity for advancement in a growing engineering department.

Reply giving full details to

**Personnel Manager
BENDIX RADIO
Division of Bendix
Aviation Corporation
Baltimore 4, Maryland**

AUTOMATIC CONTROL ENGINEER

Need graduate engineer with experience in automatic controls such as servomechanisms for experimental work covering automatic, hydraulic, and electrical controls and instrumentation used in process industries. Must have creative mind and ability to assimilate and follow thru to completion any new assignments.

P-312, Electronics
520 North Michigan Ave., Chicago 11, Ill.

WANTED

TEST EQUIPMENT ENGINEER

Must be versed in television and F. M. Receiver test practice, and capable of developing such equipment as may be required for factory production test of component parts and completed receivers.

**COLONIAL RADIO CORPORATION
254 Reno St. Buffalo, 7, N. Y.**

WANTED

SALES ENGINEERS

Long established, well-known manufacturer of Electrical Controls, desires to increase strength of sales organization.

Only well established, financially sound sales engineers or firms of highest calibre with electrical engineering background, experienced in electrical circuits will be considered.

State qualifications, sales staff, territory covered, lines representing and other pertinent information.

P-317, Electronics
68 Post Street, San Francisco 4, Cal.

WANTED

Development Engineers

(Project)

Several positions available for graduate engineers experienced in VHF techniques, communication equipment design. Excellent opportunity for right men. Midwest location.

P-313, Electronics
520 North Michigan Ave., Chicago 11, Ill.

RADIO EXECUTIVE

With Established Sales Organization Throughout EUROPE and NEAR EAST
Seeks Representation

Have engineering background: wide experience in managing own business in Europe; seeks connection with responsible manufacturers in electronic and related fields for representation in Europe and Far East. Now in U. S. A. and available for interviews.

Write Box 121, Suite 617, 1457 Broadway, N. Y. City 18

WANTED

REPRESENTATIVES AND EXPORTERS

To distribute Nationally advertised plastic control knobs. Territories open in most of the larger cities. Interested parties please reply, giving full details of your sales organization.

RW-314, Electronics
520 North Michigan Ave., Chicago 11, Ill.

**Additional
Selling opportunity
Advertisements
on page 285**



WANTED:

**SALES REPRESENTATIVES
EXPERIENCED IN ELECTRONIC
RADIO SERVICE EQUIPMENT**

Leading manufacturer of electronic and radio service equipment invites correspondence with fully experienced sales representatives who have a good technical knowledge of radio and electronic service instruments.
In writing, please give full details on experience and territory covered in contacting distributors and dealers. All replies confidential.

RW-327, Electronics
520 North Michigan Ave., Chicago 11, Ill.

ASSOCIATE WANTED

by a well-known, old established and progressive electronic parts manufacturer with national distribution. Must be able to take over complete charge of Sales. Financial participation considered. Location—Los Angeles area.

BO-302, Electronics
621 S. Hope St., Los Angeles 14, Calif.

WANTED

**To purchase or license patents
on patentable ideas on
Transformers.**

Particularly interested in ideas pertaining to Transformers and reactors for use with fluorescent lamps.

Advance Transformer Company
1122 W. Catalpa Avenue
Chicago 40, Illinois

TRANSMITTING TUBES

WL 869B.....\$60.00
Eimac 6C21.....\$ 6.00
8012A\$ 2.50
5CP1\$ 3.00

FS-318, Electronics
330 West 42nd St., New York 18, N. Y.

SELSYN GENERATORS

All sizes \$6 pr. up, frac. hp motors, focus coils, diesels, lighting plants, barometers, polaroid variable density filters, \$1.75, other surplus.

FS-316, Electronics
330 West 42nd St., New York 18, N. Y.

MOTOR GENERATORS

Built by a leading manufacturer to rigid specifications of the U. S. Navy for fire control use.

Input: 115 volts D.C. at 14 amps. 3600 rpm.

Output: 120 volts A.C. 60 cycles at 10.2 amps., single phase or 1000 watts continuous duty.

Splashproof. Fully covered. Centrifugal starter.

Brand new in original boxes including spare parts kit.

Shipping weight 290 lbs. Net weight 260 lbs. Price f.o.b. N. Y. \$87.50.

ELECTRONICRAFT, Inc.
5 Waverly Place Tuckahoe 7, N. Y.

BELGIUM

American Firms desirous to extend their activity to Belgium, are invited to contact with

SOCIETE INDUSTRIELLE ALFA

80, rue de la Senne

BRUSSELS

Oldest importer of American radio, electrical and electronic material.

SHEET METAL MACHINERY

NEW and Used — Brakes — Shears
Forming Rolls — Folders — Punches —
Di-Acro, Pexto, Niagara & Whitney Equip-
ment

B. D. BROOKS CO., INC.
Han. 5226
361 Atlantic Ave., Boston, Mass.

**REMOTE INDICATION
and CONTROLS**

Ample stock of synchronous (Selsyns & Autosyns) and low-inertia servo motors.

Also complete design and fabrication of servo amplifiers and systems.

SERVO-TEK PRODUCTS CO.
247 CROOKS AVE. CLIFTON, N. J.

AVAILABLE IMMEDIATELY

1—20 kw Westinghouse High Frequency Heating Equipment (R. F. Generator). Standard design. Power supply unit identical to that used in Dielectric Heating, Radio Broadcast, Induction Heating. Practically new equipment—used very little. For complete details write—F. V. Drake, Purchasing Agent.

COLUMBIAN ROPE COMPANY
Genesee Street Auburn, New York

FOR SALE

ELECTRONIC HEATER

One G.E. Model 4F1503 Electronic Heater with work table and output transformer complete with tubes. Output is 15 KW and rating is for continuous service. Efficiency 540 KC. Line transformer available. Heater has never been used and is in perfect condition.

**COMMUNICATION PRODUCTS CO.,
INC.**
Keyport, N. J. Tel. Keyport 7-1230

**TRANSFORMER
SPECIALS**

MADE BY N. Y. TRANSFORMER CO.

TP-4 Plate Trans. 220 V. input 50/60 cy—Sec 1220 V.C.T. @ .57 amps..... \$5.95
TF-11 Filament Trans. 220 V. input 50/60 cy—Sec 5.07 V.C.T. @ 13.5 amps..... \$4.25
TF-3 Filament Trans. Pri 220 V. 50/60 cy—Sec #1-6.4 V.C.T. @ 2.7 amps Sec. #2 10.1 V.C.T. @ 6.5 amps \$5.25
TF-10 Filament Trans. Pri 205 V. 50/60 cy. Sec. 6.4 V.C.T. @ .9 amp..... \$3.95
TF-16 Filament Trans. Pri 220 V. 50/60 cy. Sec. #1 10.2 V.C.T. @ 6.5 amp Sec. #2 10.2 V.C.T. @ 3.25 amps Sec. #3 6.4 V.C.T. @ 1.8 amps \$5.50

We also carry a complete line of electronic and communication equipment. Send for latest bulletin 2 B.

Write and Wire to—

NIAGARA RADIO SUPPLY CORP.
160 Greenwich St. New York 6, N. Y.
Bowling Green 9-7993

**BEST QUALITY, USED
ELECTRON TUBE MACHINERY**

Equipment for the manufacture of all kinds of electron tubes, radio tubes, incandescent lamps, neon tubes, photo electric cells, X-ray tubes, etc.

AMERICAN ELECTRICAL SALES CO., Inc.
65-67 East 8th St. New York, N. Y.

TRANSFORMERS

100 SOLA constant voltage transformers; input volts 95-125; output volts 115; rated V.A. 250; single phase. Cat. No. 30807.

POWERSTATS

6 SUPERIOR variable transformer, Type S-669; pri V.115; output volt range 0-135 V. Max. output 2 KVA; Max. output current 15 amps.

BLOWER UNITS

(300) 1/40 H.P. AC motor, 3400 RPM; 1 phase 60 cycle, 115 volt, with American Blower #00 Sirocco-84 CFM, bolted to motor.

Inquiries invited from
Mfrs. and Exporters

Wholesale Only

Clark-Reiss Distributors, Inc.
55 Walker St., New York 13, N. Y.
Telephone CAnal 6-7485

"Communications" HOUSE OF MICROWAVES.

A warehouse full from waveguide section to complete radar setup. Here are some sample buys.

SO RADAR TRANSMITTER UNIT 10 CM

Includes 2J26 Magnetron, TR and ATR sections. Output section, pulse transformer, McNally Klystron, IF strip, all tubes, blower motor. Completely assembled as operated by the U. S. Navy. Used, but in good condition \$150

SO RADAR ANTENNA ASSEMBLY

10 cm dipole, parabolic reflectors 24" diameter, drive and selsyn motors, wave guide couplings, rotary joint. Even the collar for mounting. Masking dome 30x30x40". Used and in good condition. \$45

New \$90
SO Radar 10 cm. echo boxes \$15

SO Radar Indicator unit, with CR tube, focusing and deflection coils, azimuth scale, all controls, tubes and components. Used and in good condition \$100

SO Radar accessory range unit, with AC Voltmeter on front of cabinet. Complete. \$35
5 ft section of 10 cm waveguide with flanges on each end \$15

In fact we ALSO HAVE complete SO Radars. Write us for quotations.

MAGNETRONS

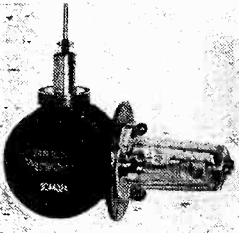

2J32 is designed for 10 cm. operation. Rated at 300 kw peak pulse power. Complete information supplied. Brand new. The 2J32 is listed at \$200. OUR PRICE \$25.00.

3J31's just received. One cm. magnetron listed at \$95.00. OUR PRICE \$20.00

Magnets for magnetrons \$12.00

720 Magnetron Value \$200. Special \$20.00

2J38 (3245-3263 Mcs) Complete with magnet 37.50

2J42 (3 cm) Complete with magnet 37.50

2J26 (10 cm) 25.00

Magnet for 2J26 12.00

KLYSTRON oscillator tubes 2K25/723ab designed for 3 cm. operation. New. With complete data. Listed at \$38.00. 7.75

McNally Klystron 707B. Limited quantity. 15.00

Tunable external cavity for 707B. 3.50

715B Pulse Power Tube. 9.50

Duplexer using 1B24 10.00

30 mc. oscillator-amplifier with 2 6AC7's. Uses 723ab, Waveguide input, xtal detector. 10.00

With 6AC7's 16.50

Thermistor Beads (D-170396), for use with UHF and Micro-Wave Equipment (List \$3.00). In separate sealed containers.95

Microwave Signal Generator. 2700 to 3000 MC. Regulated power supply 115V/60c. contains output meter. Made by Western Electric. Value \$400. Our price. \$75.00

Converter W.E. BC 437A 19.00

Pulse Transformer. High Voltage. Western Electric D 169 271. Special. 9.95

We have unbelievable bargains in 400 cycle transformers. At this price you can figure out your uses for them. Most sizes at 50 cents each—send us your voltage requirements.

Silver Plated Directional Couplers with a 20 DB drop with:

A. With 90° bend. 15" long. \$4.00

B. 15° bend in wave guide 15" long. 4.40

C. 30° bend in wave guide 10" long. 3.95

D. 90° bend in wave guide 15" long also 90° bend in coupler. 5.00

SECTIONS

E. 2½ foot silver plated with 180° bend (2" radius) 5.50

F. 150° bend with 90° twist 3" radius with pressurizing nipple and coax coupler. 3.95

G. 2½ foot 3 cm wave guides choke to cover fittings 4.95

H. 5 foot 3 cm wave guide section per foot. 1.95

J. Slotted dipole antenna 3 cm. 4.00

K. 10 foot 10 cm wave guides, per foot. 2.00

L. Brass choke flanges—opening ½"x1", 7/16" thick60

All merchandise guaranteed. Mail orders promptly filled. All prices F.O.B. New York City. Send Money Order or Check. Shipping charges sent C. O. D. Send for our latest Microwave Flyer also our complete parts catalog.

COMMUNICATIONS EQUIPMENT CO.

131-E Liberty St. New York City 7, N. Y.

Telephone WH 4-7658

NEW C. R. TUBES



Tube Type	Approx. List	Your Cost
3BP1	15.00	3.95
3FP7	27.00	2.98
5BP1	20.00	4.95
5BP4	27.00	7.95
5CPI	45.00	4.95
5CP7	48.00	6.00
5FP4	35.00	4.95
5FP7	32.00	4.95
5JP2	48.00	8.95

837	2.80	1.50
872A	7.50	2.45
705A	22.50	6.75
241B-WE	85.00	40.00
861	155.00	50.00
3B24L	12.00	3.95
3C45	5.95

Sockets for 5CPI; 3BP1, & 5BP1 and similar types of tubes \$.95

OIL FILLED CONDENSERS

G.E., C-D, W.E., and other well known brands	
1 mf 300 vdc.25	4 mf 600 vdc pyr .70
2 mf 300 vdc.30	6 mf 600 vdc pyr .95
4 mf 300 vdc.35	8-8 mf 600 vdc. . . 1.49
4 mf 400 vdc.55	15 mf 220 ac/600 dc1.50
5-5 mf 400 vdc.1.15	1 mf 1000 vdc. . . .90
2 mf 550 vdc.30	2 mf 1000 vdc. . . .1.10
.25 mf 600 vdc.25	1 mf 1500 vdc. . . .1.20
.85 mf 600 vdc.30	1 mf 1500 vdc. . . .20
1 mf 600 vdc.35	4 mf 2000 vdc. . . .1.10
2 mf 600 vdc.40	2 mf 660 ac/000 pyr. .65
3 mf 600 vdc pyr. .65	1 mf 2500 vdc. . . .1.75
10-10-10 mfd synchro capacitor	.1-1 mfd 7000 vdc G-E pyr. 2.00
90v 60 c.2.50	

HI-VOLT CONDENSERS

2 mf 4000 vdc 23F47 \$5.75
G.E. Pyranol 23F49 1 mf-5000v list \$27. 5.95
C-D TC-50010 1 mf 5000v (list \$30) 4.50
G.E. 14F191 .1 mf 10,000v (list \$37) 6.75
.06 mf 15,000 vdc GE pyranol 26F585-G2 \$5.95
.75 ml. 20,000 vdc GE pyranol 14F136 \$22.00

HI-VOLT TRANSFORMERS

AMERTRAN PLATE TRANSFORMER, 115v-60-cycle primary, 6200 volt-ct-700 mill secondary. Size 11"x14"x10". \$39.95
Same transformer without center tap \$34.95
2.6 Hy 800 Ma Choke. Stud Terminals \$5.95

Power Supply for LM-18 freq. meter

Output: 290v @ 20 ma; 13v @ 600 ma.
Input: 105-125v @ 60 cps; 260 ma; 27.6 W. with type 84 rectifier tube; shock mounted. Complete with input and output plugs. \$14.75

HI-VOLTAGE POWER SUPPLY

POWER UNIT RA58-A \$116

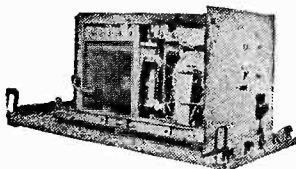

Ideal for breakdown insulation testing, or as a source of power for a pulse transmitter. This unit supplies continuously variable voltages between 500 and 15,000 volts, DC at 34 ma. A voltage doubler circuit using two 705a rectifiers and two 1 mf condensers is employed. BMS ripple voltage at maximum power is 6%. THIS UNIT OPERATES FROM 115 v/60c. Variable voltage is obtained by means of a Variac in the primary circuit of the high voltage transformer. Size is 21"x17½"x29" deep. Net weight 314 lbs.

APS-10 MODULATOR ASSEMBLY

Includes 2J42 magnetron, magnet, output wave guide, 2-3B24's-3C45 relays, blower motor, relays, other parts together with low voltage power supply assembly, chokes, condenser, transformer, both a buy for \$50

Choke 2 hy 200 ma tested at 2500v.60
Choke 5 hy 400 ma tested at 2000v.98
Choke 10 hy 200 ma. 2.00

PORTABLE METERS

Surplus—New—Guaranteed
GOV'T INSPECTED

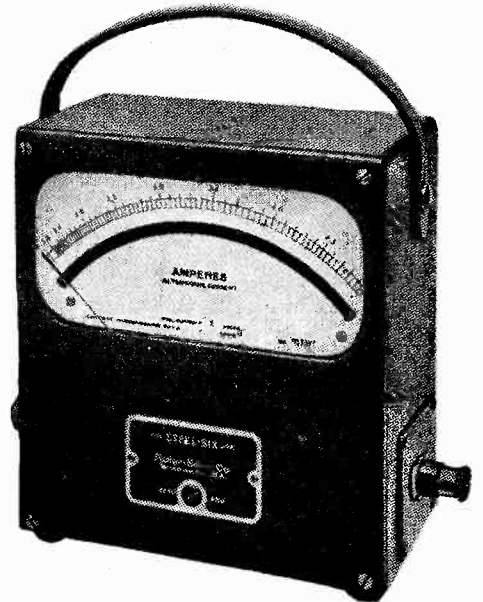

PORTABLE A. C. AMMETER

ROLLER SMITH MODEL "STEEL SIX" (see illustration) 0-5 Amperes, accuracy within ½ of 1%; Hand Calibrated Mirror Scale 5 3/16" long with 100 scale divisions; Knife edge pointer; Moving Iron Vane type completely shielded from external magnetic fields. Dimensions 6"x6"x4".

ONLY \$19.50

PORTABLE A.C. VOLTMETER

WESTON MODEL 433 0-600 volt A.C., accuracy within ¾ of 1% from 25 to 125 cycles. Hand Calibrated Mirror Scale 4.04" long with 150 Scale divisions. Knife edge pointer, Moving Iron Vane type, magnetically shielded. Dimensions 5"x6"x3½". List Price \$59.50. **ONLY \$27.50**

PORTABLE D.C. VOLTMETER

ROLLER SMITH "STEEL SIX" (similar to above illustration) DUAL RANGE 0-15 and 0-150 volt D.C. Accuracy within ½ of 1%; Hand Calibrated Mirror scale 5.18" long with 150 scale divisions; Knife edge pointer; magnetically shielded; 100 ohms per volt movement; Dimensions 6"x6"x4". List Price \$48.00. **ONLY \$21.00**

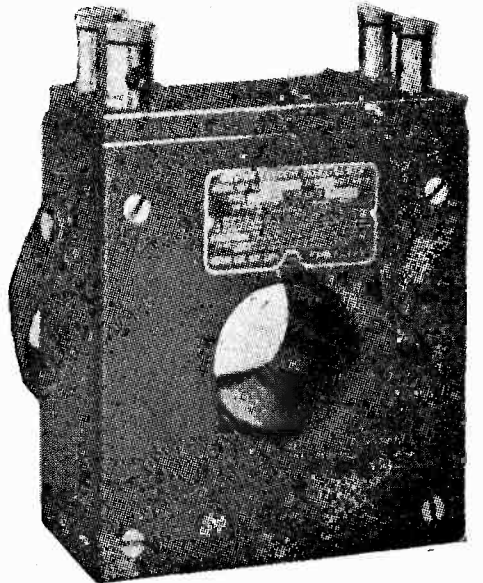

PORTABLE CURRENT TRANSFORMER

WESTON MODEL 461 TYPE 4 (see illustration). This unit can be used with any precision 5 Amperes A.C. Meter to extend the ranges of the meter to 50, 100, 200, 250, 500, or 1000 Amperes A.C. Accuracy within ¼ of 1%; Normal Secondary Capacity = 15 VA; Binding Posts for 50 Ampere tap; Inserted primary for 100, 200, 250, 500, and 1000 Amperes; Insulated for use up to 2500 volts. List Price \$98.00.

ONLY \$35.00

ALL PRICES F. O. B. N. Y. C. MARITIME SWITCHBOARD

338 Canal Street New York 13, N. Y. Worth 4-8217

SURPLUS METERS

MICROAMMETERS, GALVONOMETERS

Triplett, 3 1/2" square, 100 microampere movement. 950 ohms resistance, made for 666-SC Analyzer; Scale marked in volts and ohms\$6.95
 Marion, 2 1/2", 200 microamp undamped mvt., spec. sc.....\$3.50



G. E., DO-41, 3 1/2", 200 MICROAMP Mvt., SPEC. SC. KNIFE EDGE POINTER, COMP. WITH PAPER V-O-M.A. SCALE\$6.00

W.E., 3 1/2", concentric style, 0-200 microamp\$4.00
 G.E., DO-41, 3 1/2", 0-50 microamp mvt. scale 20 K.V., comp with paper V-O-M-A. scale.....\$4.95

G.E., DO-53, 3 1/2", square, 500 microampere movement; 15 K.V. scale; Complete with paper Volt Ohm Milliammeter Scale.....\$4.50

D. C. MILLIAMMETERS

W.H., RX-35, 3 1/2" square, 0-1 M.A., 55 ohms, internal resistance, complete with paper V-O-M-A. scale.\$4.95
 G.E., DW-41, 2 1/2", 1 M.A.....\$3.95
 Gruen, 2 1/2", 3 M.A. movement scale 0-30, 450 & 300 volts M.A.....\$2.00
 Simpson 26, 3 1/2", 0-15 M.A.....\$4.50
 G.E., DO-53, 3 1/2" square, 20 M.A.\$3.25
 G.E., DO-41, 3 1/2", 50 M.A. Black scale\$3.25
 W.H., NX-35, 3 1/2" 200 M.A.....\$4.00
 Simpson 3 1/2", 0-200 M.A.....\$4.50
 Burlington, 3 1/2", 0-200 M.A.....\$2.75
 DeJur Amsco, 3 1/2", 0-1000 M.A...\$3.00

D.C. VOLTMETERS & KILOVOLT METERS



G.E., DW-41, 2 1/2", 15 VOLT BLACKSCALE, 15 MARKINGS, NO CAPTION..\$2.50

Western Electric, 3 1/2", Concentric Style, 0-75 volt D.C., 1000r/.....\$3.00
 W.E., 3 1/2", 500 volt, 1000 r/v Concentric Style\$5.00
 W.H., NX-35, 3 1/2", 1.5 K.V. comp. with 1000 r/v ext prec resist...\$6.95
 W.H., NX-35, 3 1/2", 20 K.V. com with 1000 r/v ext prec resist L.P.\$210.00
 Your cost\$21.00

D.C. AMMETERS

Triplett, 3 1/2", 0-15 amp.....\$4.00
 Weston 506, 2 1/2", 200 amp. with ext shunt\$7.50
 G.E., WD-41, 3 1/2", 200 amp. with ext shunt\$12.50

RADIO FREQUENCY AMMETERS

Weston 425, 3 1/2", 120 M.A., F.F..\$8.50
 G.E., DW-44, 2 1/2", 0-1 A.R.F., Black scale\$3.50
 G.E., DO-40, 3 1/2", 1.5 Amp.....\$6.50
 Weston 507, 2 1/2", 0-1.5 A.R.F. Black scale, Metal case.....\$2.95
 Westinghouse, NT-35, 3 1/2", 3 A.R.F.\$5.50
 Weston 507, 2 1/2", 3 Amp bk sc....\$3.50
 G.E., DW-52, 2 1/2", 3 A.R.F., Bl. scale\$2.95
 Simpson 2 1/2", 3 Amp, expanded at lower part of scale.....\$3.50

A.C. VOLTMETERS

G.E., AW-42, 2 1/2", 0-10 V.A.C....\$3.95
 G.E., AO-22, 3 1/2", 150 Volt.....\$5.50
 W.H., NA-35, 3 1/2", 15 Volt.....\$3.95
 W.H., NA-35, 3 1/2", 150 volt.....\$5.50
 Triplett, 331-J.P., 3 1/2", 150 Volt..\$4.50
 Weston, 476, 3 1/2", 300 Volt.....\$8.00
 Weston, 517, 2 1/2", 300 Volt.....\$6.00
 Triplett 232 C, 2 1/2", 300 Volt, metal case\$4.00
 G.E., AO-22, 3 1/2", 500 Volt.....\$12.00

A.C. AMMETERS

Triplett, 331-J.P., 3 1/2", 30 Amp...\$4.00
 Simpson, 1/2" square case 60 amp S.C.\$3.50
 Triplett, 3 1/2", 0-75 Amps A.C.....\$3.50
 G.E., AO-22, 3 1/2", 80 Amp S.C....\$3.50

SPECIAL METERS

Weston, 301, Type 61 Decibel Meter, 3 1/2", -10 to +6, 6 M.W. 600 Ohms; High speed type .29 - .35 Sec. to final reading. Complete with external wire wound precision resistors to extend the range to any or all of the following ranges:
 - 20 to + 16 DB — 50 to + 46 DB
 - 30 to + 26 DB — 60 to + 56 DB
 - 40 to + 36 DB — 70 to + 66 DB
 List Price = \$31.10....Your cost \$9.50
 Marion, 2 1/2", ring mtd "S" meter made for National Co. 1 M.A. mvt scale "1-9 S units 0-40 D.B. above S 9"\$3.50
 Roller Smith, miniature, 1 1/2" sq 1.37 M.A. mvt, spec bk sc.....\$2.50
 Roller Smith, miniature, 1 1/2" sq 2 M.A. mvt, with 2' lead & plug jack 0-10 div sc.....\$2.50

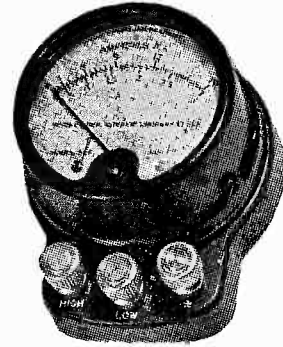

PORTABLE A.C. AMMETERS Surplus New WESTON MODEL 528

DUAL RANGE 0-3 Amp. and 0-15K Amp. full scale for use on any frequency from 25 to 500 cycles. The ideal instrument for all commercial, industrial, experimental, home, radio, motor and general repair shop testing. Comes complete with a genuine leather, plushlined carrying case and a pair of test leads. A very convenient pocket sized test meter priced at less than 50% of manufacturers list. Your cost ONLY.\$12.50

Portable A.C. Voltmeters

(See illustration of Ammeters)
SURPLUS NEW WESTON MODEL 528

DUAL RANGE 0-15 and 0-150 Volts for use on any frequency from 25 to 125 cycles. Complete with plushlined leather carrying case and a pair of test leads. This Voltmeter, with the matching model Ammeter as illustrated above, makes an ideal pair of test meters for any mechanic to carry around in his tool box....Only \$9.50 Combination Offer; 528 Voltmeter 528 Ammeter
 BOTH For\$21.00

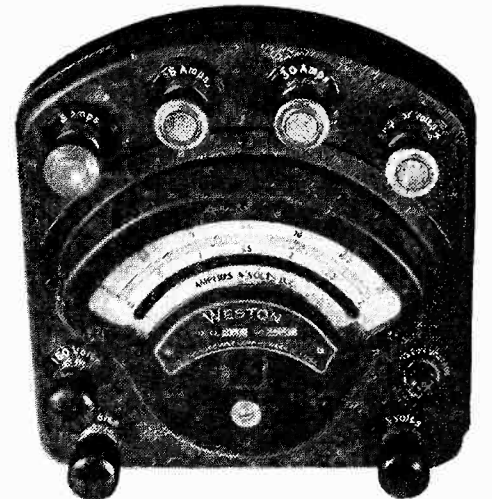

PORTABLE D.C. VOLT-AMMETER WESTON MODEL 280, 0-3, 0-15 and 0-150 volts; 0-3, 0-15 and 0-130 Amps D.C. SIX RANGES IN ONE INSTRUMENT, Accuracy within 1%; Hand Calibrated Mirror scale 2.76" long with 60 Scale divisions; Knife edge pointer, magnetically shielded. Condition — Only very slightly used — like new. List Price\$43.00
 Surplus Price\$15.00

MARITIME SWITCHBOARD

Worth. 4-8217. 338 Canal St., N. Y. 13, N. Y.

All meters are white scale in round, flush, bakelite cases, unless specified otherwise.
 Add sufficient money on parcel post orders, excess will be refunded.

ALL SHIPMENTS F.O.B. N.Y.C.



HERE'S YOUR OPPORTUNITY to make a real saving on a *Complete Radio Station*

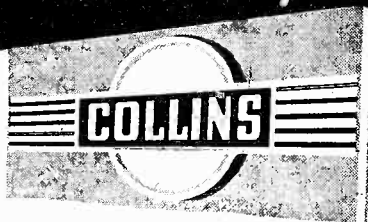

FOR REGULAR OR EMERGENCY SERVICE

- ★ FIXED STATION
- ★ PORTABLE
- ★ MOBILE
- ★ MARINE

\$350

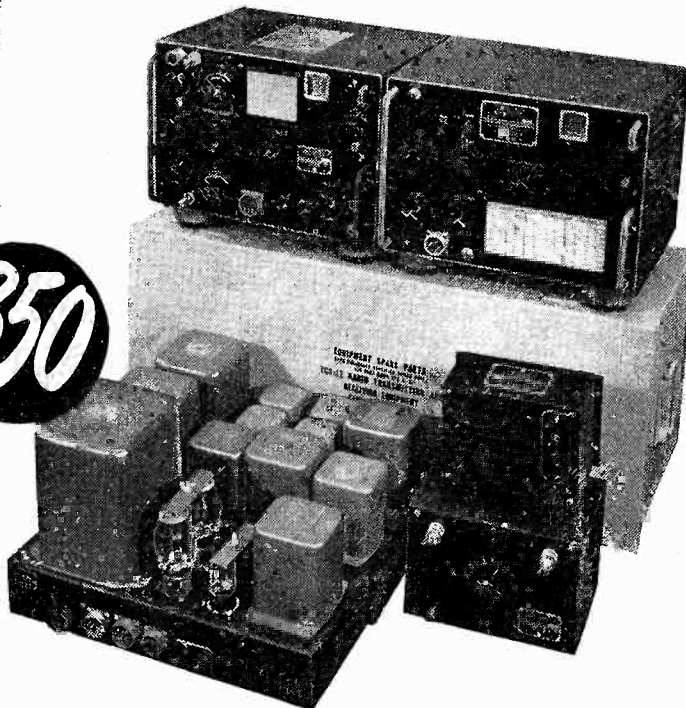
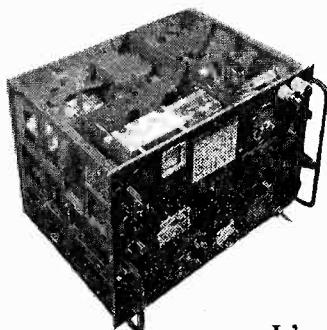

It's the U.S. Navy Model TCS-12 Radio Telephone and Telegraph Transmitting and Receiving Equipment—built by COLLINS and now offered—brand new—in its original, unopened, export packing—at an astoundingly low price.

This is an ideal communications equipment for municipalities, utilities, airports, and commercial users—it's complete and finished with enough spare parts for a lifetime of normal maintenance; 203-page manual gives detailed data, photographs, diagrams, and instructions for operation and service.

The Complete Equipment Includes #52245 7-tube Radio Transmitter —

25 watt telegraph; 10 watt phone; band switching 1.5—3—6—12 mc; provision for 4, crystal-controlled frequencies or continuous coverage with VFO; very stable and easy handling.

#46159 7-tube Radio Receiver

3-band superheterodyne using either crystal or master oscillator control; 6 milliwatts output at 15 microvolts input; ample selectivity and low distortion.

#20218 115-volt 60 cycle Power Unit

with two, full-wave vacuum tube rectifiers for plate supply and a dry-disc rectifier for filament supply in transmitter and receiver.

#23270 Remote Control Unit

for both transmitter and receiver; includes loud-speaker, phone jack, and output selector switch.

Accessories

Antenna loading coil; telegraph key; microphones; and all necessary cables and plugs for interconnecting the various units.

Spare Parts

The spare parts chest includes over 200 items of transformers, capacitors, relays, resistors, switches, cables, plugs, insulators, etc.

Every part of this equipment is painstakingly and sturdily built to withstand the severest possible service. It's a heavy-duty, professional equipment of the highest quality. Price — as described \$350.

ALSO AVAILABLE

these useful pieces of radio receiving, transmitting, and measurement apparatus—

BC-348 RECEIVER - \$49.50
6-band switching 200 kc to 18 mc (less BC band). Dynamotor for 28-volt d-c use; detailed instructions for converting to 110-volt a-c.

SCR-522 VHF-XMTR RECEIVER \$39.50

push-button operation on 4 crystal-controlled channels. 28-volt d-c dynamotor powers entire apparatus.

FREQUENCY STANDARD

BC-221 \$39.50
fundamental ranges 125-250 & 2000-4000 kc with stability better than .005%. 110-volt a-c, vibrator, or battery operation.

BC-375 XMTR \$35.00
covering 200 kc to 12 mc (less BC band) with 7 tuning units. With BC-306-A antenna tuning unit and PE-73-C dynamotor unit.

All of the above equipment is used, but in excellent physical and electrical condition.

The RADIO SHACK Corp.

CABLE ADDRESS · RADIOSHACK
167 E WASHINGTON ST., BOSTON, MASS., U.S.A.

IN STOCK

- 2000 Dynamotors GE input 27V at 1.75A, output 285V at .075A and Black & Decker input 28V at 1.4A, output 260V at .07A, \$1.35 each
- 500 New Steel Junction Boxes 14 ga. 17" x 25" x 6 1/2" with screw type. Brass hinges on lid. Two access panels. Watertight, \$2.75 each.
- 65,000 Extension Cords over 8 ft. long male plug on one end. Rubber covered wire. U. L. Inspected. \$12.50 per 100.
- 3500 Selsyn Differential Motors 115 V. A. C., 60 Cy. Packed for overseas, \$1.75 each.
- 500 Relays Struthers-Dunn 115V. A.C. 6A contacts, 4 pole double throw. \$2.65 each.
- 100 Motors G.E. Explosion Proof 250 V.D.C. 1/6 H.P. Brand New. \$16.00 each.
- Brass Machine Screws 2-56, 4-40-632, 8-32 Washers, Allen Head Set Screws.
- 6,000 Shock Mounts in 9 different types and sizes.
- 800 Selenium Rectifier 18V input 12V output at .6 amps., \$1.00 each.
- And over \$300,000 worth of Radio Parts, Mica Condensers, Resistors, Aluminum Tubing Coax Cable, Small Gears and Tube Sockets.

Mail us your inquiries

Reliance Merchandising Co.
Arch corner of Croskey St.
Rittenhouse 6-4927 Phila. 3, Pa.

ROTATORS

Plenty husky for any beam a Ham can dream up! Navy SO-1 Radar type. Beautifully built. Automatic lock-in. Instantaneous reversing. No over-swing. Demountable reflector, wave-guide nozzle. \$59.50 fob. N.Y. new in original heavy crates. Shipping weight 490 lbs. (stripped for Ham use 150).

110v 60 cycle operation using your parts, or our kit with tapped transformer (permitting 1-2 rpm.), seleniums, condensers, instructions \$19.50. Further details, photograph, 25 cents.

ELECTRONICRAFT, Inc.

5 Waverly Place Tuckahoe 7, N. Y.

Special Values

Panel & Portable Meters

D. C. Microammeters:
50-100-200-500 microamps. High Resistance Voltmeters Vacuum Thermo-Couple Meters 3 1/2" & 4 1/2" Round & Rectangular

Multirange Portables:
readings from 10 microamps. full scale

Precision Electrical Instrument Co.

146 Grand Street New York 13, N. Y.

METERS AND INSTRUMENTS

- | | |
|--------------|----------------------|
| VOLTMETERS | BRIDGES (Wheatstone) |
| AMMETERS | MEGOhmmeters |
| MICRO | RHEOSTATS |
| Ohmmeters | VARIABLE |
| Ohmmeters | TRANSFORMERS |
| FREQ. METERS | RELAYS |

ELECTRO-TECH Equipment Co.

119 Lafayette St. New York 13, N. Y.

"TAB"

That's A Buy

NEW GUARANTEED

ELECTRONIC PARTS



VACUUM CONDENSER
100 mmf/7500 V.
24Amp/28mc's, List price...\$12
Dimensions 4-9/16"x1-5/8" Dia-
9/16"D Terminals. "TAB" special
.....\$4.95
Two for 8.95

VACUUM CONDENSER
50mmf/7500 V.
20Amp/32mc's, List price...\$10
Dimensions 3-5/16"x1-5/8" Dia-
9/16"D Terminals. "TAB" special
.....\$4.50
Two for 8.40
MFG'ED by G.E. or equiv.

OIL CONDENSERS

4mf/50WVDC, Ten for \$2.00
10mf/600WVDC, Two for 2.50
20mf/600WVDC, Two for 4.95
4mf/600WVDC, TLA, 2 for 1.25
Tubular 0.1mf/600WVDC, Ten for 1.90
Tubular 0.1mf/800WVDC, Ten for 2.20
Tubular .01mf/1500WVDC, Ten for 1.50
3mf/330VAC/1000WVDC, GE Pyranol 1.25
4mf/330VAC/1000WVDC, CD Dykanol, 2 for 2.98
15mf/330VAC/1000WVDC, GE Pyranol 2.95
2mf/2000WVDC, Avx&Wst, Two for 4.25
3mf/2000WVDC, Avx&Wst, Two for 5.00
2mf/5000WVDC, CD, Two for 14.50

2mf/5500WVDC, WST INERTEEN \$7.95
2mf/12500WVDC WST 25.00
1mf/2500WVDC WST INERTEEN 75.00
0.5mf/600WVDC Bathtub, Five for95
2mf/600WVDC, TLA, Two for79
0.5&0.5mf/600WVDC, Bathtub, 5 for95
0.1&0.1mf/600WVDC, Bathtub, 5 for95
0.25&0.25&0.25mf/600WVDC, Bathtub, 4 for 1.00
0.3mf/600WVDC Tubular, 5 for95
0.1molded/600WVDC paper, Ten for90
0.05molded/600WVDC paper, Ten for 1.15
0.5&.05mf/300WVDC oil, 15 for 1.00
0.1mf/300WVDC molded paper, 14 for98
0.25mf/200WVDC molded paper, 14 for98
0.1mf/400WVDC molded paper, 10 for75
0.25&.25&.25mf/400WVDC Bathtub, 5 for 1.00
0.25mf/1000WVDC, Four for 1.00
0.25mf/1500WVDC, Three for 1.00

GR VARIAC 200CU/860Watt New \$14.95
TRANSTAT 88to132V/18.2A-110V New .. 29.50
Blowers *L.N. 115V/60cy Dual 200 CUFTM 13.95
DYNAMOTOR 12&24Vinpt, 275V/110ma &
12V/3A New Navy PMfield 1.95
Dynamotor 12&24Vinpt, 500V/50ma 1.95
RELAY TIME DELAY 115V/10Amp 1.49
NEON SIGLITE V4/GT Dual Tel plug
3 for 1.00
PRECISION 1% Onemeg resistors 3 for 2.45
SHALLCROSS TEN POINT DECADE
SWITCH @97

0.5mf/1500 TLA, Two for \$1.49
0.02mf/600WVDC Tubular, 10 for98
0.1mf/1000WVDC, Five for 1.00
0.03mf/400WVDC, 15 for 1.00
0.1 & 0.1 & 0.1mf/400WVDC, 5 for 1.00
.001&.006mf/1000V/600WVDC, 20 for 1.00
2mf/600WVDC TLA OIL, 2 for79
25mf/1000V Wkg New, 3 for75
6mf/1500WVDC OIL, 2 for 4.50
.01mf/2500V Mica (\$3.40), Two for 1.00
.01mf/5000V Mica (\$5), Two for 1.80
.0042mf/8000V Mica (\$36) 4.50
.0003mf/10000V Mica (\$42) SANGAMO G2.. 4.95
00015mf/20000V EFF AVX1970-404 Mica.. 7.50
00015mf/5000V AVX Mica 3.49
00009mf/5000V AVX Mica 3.50
CONDENSER KIT Silver&Mica, 50 for 2.00
CONTROL KIT ABJ 50to2meg Pots, 10 for 2.50

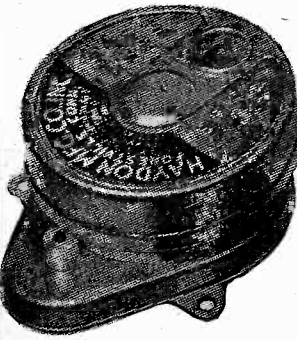

SYNCHRONOUS HAYDON CLOCK-MOTOR 60cy/10V 24 RPM S.P. SWITCH EXCELLENT FOR AUTOMATIC KEY-ER, EXPERIMENTAL WORK, TIME DELAY, FLASHER, PRODUCTION TESTING, CLOCK 100's of uses, GOVT Cost (\$7) "TAB" EXTRA SPECIAL \$1, Two for \$1.69.

ANTENNA SECTIONS SCM50; 39 1/2" long, Twelve for \$1.00

COLLAPSIBLE TELESCOPIC ANT., AN30 12" to 9 feet \$1.49
WE Dynamlo mike 9.95
EDISON TIME DELAY RELAY 115V/10Amp 1.49
RF Choke 2.5MH/500ma HAMLUND CH500.. .69
RF Choke 88MH/HAMLUND (\$3)97
RF Choke 250MH/HAMLUND (\$4)97
RF Choke 1MH/300ma NATIONAL, 3 for89
RF Choke 20MH/500ma HAMLUND 1.10

Television Pulse Transfer for BTO \$1.49
Navy Sea Trunks *L.N. 22"x16"x12" Fibre 3.00
Power Rheostats Assmnt 25&50W, 6 for 4.95
Weston 796 Oak Case 8 1/2" Sq-2Compant&Locks
Rotary Beam Coupler Const. Impedance 3.95
Trans 1100VCT 212ma Collins 6.50

RADIO EQUIPMENT RC-148-C—2 Units Power Supply Furnishes all voltages For Equipment Inpt 343Watts 117.5V 60cy Contains 4FII&Plate Trans Chokes, etc. Trans-Receiver Ant. Match Section Pulse Shaper, Mod, RF Oscillator Range 154-186 Mc Superhet RF&IF Stages Video Amp Tuning Eye, etc. Freq can be lowered to 114-148Mc. "TAB" PRICE \$49.95

Resistor Kit BT 1/2 & 1 Watt 50to2meg, 100 for... \$2.50
W.W. Resistor Kit, 20 for 1.00
Knob Kit Asst With Bushings, 25 for 1.25
Rotary Switch Kit, Six for 1.75
Socket Kit 25 Asst Ceramic, Mica, B, etc 2.35
RM-53 Remote Control for Transmitter Also
TL 3.49
Transf line to line 500, 333, 250, 200, 125, 50 ohms — IDB Cased THERMADOR Mfg 1.95
Micro Switch-MU Leaf SPDT 15A/125V, 2 for 1.08
Bias Trans 90, 80, 70V 1 Amp Cased GE 2.95

VIBRAPACK & STORAGE BATTERY NEW 4V/40AH-50V Output 156V/30ma, 3V/375ma/1.5V/200ma 7.5V/20ma, NAVYMANUAL NEW COMPLETE TBY \$9.95
OSCILLOSCOPE 3" KIT 3BPI Includes Transf 115V/60cyPri 375VCT/110ma, 1320V, 5V/3A, 2.5V 3.25A, 6.3V/2.75A, New Tubes 3BPIC/Ray, 5Y3GT Rect, 2V3G Rect, Condrs, Choke, Low&HV supply. Complete "TAB" PRICE 16.95
FOXBORO MECHANICAL RECORDER with 110V/60cy Motor-Mech & Elect Recording (\$200) 69.95

RCA 808 JAN-CRC New Gtd Fil 7.5V/4A Plate 1500V/200Watts Rated 140Watts Output each UHF (List \$7.75) "TAB" PRICE \$2.70. Two for \$5.00
1625 (S'807) Boxed New, 2 for 1.30
446A/2C40 Lighthouse Tubes 2.85
807 JAN GTD New, Two for 2.00
304TL GTD New, Two for 7.81
955 JAN GTD, Two for 1.45
956, 957, 958A, 959 & socket, Each90
872A New & Sockets, Two for 5.75
866A New & Sockets, Two for 2.00
3B24 HV Rectifier 20000V/60ma 4.95
2V3G JAN HVRECT 16500V (\$3.40), 2 for 1.50
829B/3E29 Boxed Gtd New 2.90
3BPI Boxed JAN New Gtd & Socket 2.99
5BPI or 5CPI New Gtd 3.95
2C26 Boxed New 10Watts UHF, 2 for 1.50

TRANSFORMER Cased LANGEVIN Pri 105to250V 50/60cy Sec2240VCT/500ma 12V/4.5A, 19V/2.5A, 2.5V/10A, HV Insl \$11.50, Two for \$19.95
KENYON T-216, 115V/60cy 1040VCT&80V 250ma 5V/3A, 2.5VCT/3, Two*6.3VCT/3A Csd 7.00
TRANS 840VCT/110ma, 530VCT/31ma 5V/3A, 5V/3A, 6.3/1MA, 6.4/.6A, 115V/60cy Pri&Two10hy/110maChokes & 2/2.5 mfd&5mf 600WVDC Cond w/Chassis.. 6.95

954 Boxed New Gtd @50¢, Five for \$2.00
6AK5 Boxed New Gtd @ \$1, Ten for 8.90
6AG5 Boxed New JAN @81¢, Ten for 7.49
2050, 2x2, RK60/1641, 6SL7, 1E7G @ 1.25
35L6, 50L6, 35Z5, 12SQ7, 12SH7, Two 1.80
WE 717A Door Knob Tube New, Two for 3.85
WE 703A UHF Door Knob Tube New 5.95
6V6 JAN Gtd, Two for 1.80
805 or 845 JAN & Sockets, Two for 8.95
5BP4 JAN & SOCKET 4.90
NE 15&51 Neon Glamp 1/25 Watt, 10 for80
MAZDA #44 Minbay 6.3V/250ma, 10 for75
WESTON 15VAC Meter 3" Sq 476 Model 4.25
GE 2.5&25ma Zero Ctr Galvo 3 1/2" B'C 3.95
SOCKET Octal AMPH 78ST, 25 for 1.50

F3 RECEIVER RELAYRACKMTG 3 1/2"x19" Fixed Tuned XTALSUPERHET USES 6K7 RF&IF 6K8 MIXER 6C8 DET&BFO 6F7DET AVC 6C8 AUDIO & NOISE LIMIT 80RECT, 115V/60cy Pwr Supply Case Coils Tubes, No Xtal Use as Converted V.F.O. Complete with Instrument Book & Tubes \$13.45
THERMADOR SC RATED 3800VCT/6KW 2.7Amp PRI 200, 210, 220, 230, 240/50-60cy Cased Oil Filled 45.00

\$2 Min. order FOB N.Y.C. Add Postage all orders and 25% deposit. Worth 2-7230. Send for catalog 99. Specialists in International Export, School, College & Industrial trade. Money-back "TAB" Guarantee.

RCA 808 JAN-CRC New Gtd fil. 7.5V/4amp. plate 1500V/200 watts Rated 140watts output each "UHF" (List \$7.75) "TAB" price \$2.75@. Two for \$5, with sockets & caps \$5.40
VT/27A Tube New & Connectors, Two for \$5.98
SELEN IT&T 6B8VI F.W. 85V/2.4A RECT 6.95
COPPER OXIDE WST RECTOX F.W 12V/1.25Amp 3.40
MAZDA #323/3V/190ma (LP \$1.85), Four for 1.00
MAZDA #49 Minbay 2V/60ma (15¢), 10 for 1.00
SOCKET MAGINAL CERAMIC 49-SS11L49
GE 3" B'C 150VAC Meter Rd New 4.95
CRYSTALS AMATEUR FREQ, Four for 3.00
CONTRACTORS 4PST-N.O/30Amp/110V Inpt CH 4.95
TBY COMPLETE WITH VIBRAPACK 39.95
TRANSFORMER Output PP6V6/10Watt Cased 1.49
TRANSF Cased Tapped Line to V. C. 1.20
FUSE ASSMNT 250ma, 4Amp, 200ma, 300 for TRANSFORMER GE HVInsl 115V/60cy Output, Two 5V/8A 4.50
TRANSF HV Insl 220V/60cy Output 5V/20 Amp 4.50
TRANSF HV Insl 115V/60cy Output 5V/125 Amp 7.95
NATIONAL XC-5 Ceramic 5P Socket, 4 for 1.00
Hmtlly cased Chokes 10Hy/125ma/185ohms, Two for 2.50



WE Ouncer Min PP/P to PP/G HIFI (\$21)... \$1.49
Hilmp SC Headsets with 8" Cord & Plug 3.25
S.C. Key with 6ft. Rubber Cd&PL55 Plug75
Choke GE 5Hy/1Amp, Four for 1.98
TBY VIBRATOR & CK1005 Rect Tube New.. 2.50
Combination PP Output & Line Trans 1 ea (2) 2.49
LS3 HVI-DUTY PM SPKR & Case & Transf.. 4.95
Pulse Trans 0.4MU Sec Horiz BTO Telev 1.49
Pulse Transf 5MU Sec BTO Tel 1.95
TRANSF 6.8V-4V/10A, 6.5V/6A, 5V/6A, 5V/3A, 5V/3A 3.95
UTC 6L6 PP 3800ohm CT 18to45Watt.Sec 2.5, 6.5, 15.5, 62, 250ohms HIFI 3.95
UTC LINE AUTOFORMER LVM-11/30watt up to 10/500, 250, 167, 125, 100, 83, 71, 62, 50ohmL 3.95
CHOK 8 Hy/100ma Hmtlly sealed 1.10
COLLINS TRANS/Mfgd CHT Pri 115/50-60 cy Sec 1100VCT/212ma & 2 10hy/125ma Chokes 7.75

TRANSF & CHOKES UTC-115V/60cy 3200 VCT & Tap 1560VCT/200ma&Two Chokes & 2/2mf/2000WVDC Condrs&866A's & Trans \$28.95
TRANSF 1200VCT/350ma PRI 105-120V/50cy 6.95
TRANSF 10VCT/8Amp 115V60cy Inpt. 3.50
IFS 7 1/2mes STAGGER TUNED 3mes Band width Video Telev IFS 7 Units 6.95
WE KS5825 SELENIUM RECT SUPPLY VARIABLE INPT 115/230V-50/60cyOut pt.4Amp115VDCRipple 0.5%RMSOutps up to 1.5ADCRelayRackMtg TeleSys 25.00

NAVY SP3" SYNCHROSCOPE NEW \$59.50
Ext Cord Hvy Duty SJ16" & Male & Fem Plug 1.00
WE Crystals boxed New IN21-22-23 3 for 1.25
WESTGHEAL Dual AN Ind 200microamp 4.50
GE METER 2 1/2" B'C OneMilliamp 2.95
GE METER 2 1/2" B'C Five Amp RF 3.50
GE METER 2 1/2" B'C One Amp RF 3.95
GE DNI 1 1/2" MTR OneMa/100ohms 2.95
MICROPHONE T17 (LN) PB CARBON & CD DAVEN ATTNTR "T" 600/600ohm 30DB/10 Pas 1.69
DAVEN ATTNTR "L" 5000ohm 60DB/10Pas 4.95
DAVEN ATTNTR "POT" 5000ohm 60DB/30Pos 1.45
DAVEN 13CKT Sw 2SPDT/3SPDT/SP3P HV VOM ELECTRONIC SC I-107-F COMP 24.60
WE MIKE DYNAMIC 20" CABLE & STD 9.95

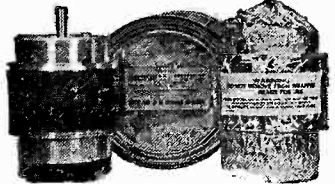

Autosyns Bendix

Brand new gov't sealed and inspected packed in overseas cans, synchro-transmitters AC, 115v. 60 cy. operation. Continuous heavy duty. Precision accuracy made for gun-fire control. Cost gov't \$90 each. 5 lbs. each "TAB" special two for \$18.

S.C. TUNING UNIT BC-746A&2XTALS FT243 \$1.00
FRIEZ BAROMETRIC VARIABLE 14000ohm97
SPRAGUE 10Meg TenKV MEGOMAX MFAI. 1.75
SPRAGUE 12Meg 12KV MEGOMAX MFAI. 1.95
IRC WW1/2of1% H'mtly Sealed Navy Resis (\$24) 1.69
WRITE FOR OTHER SIZES FROM STOCK

"TAB" • Dept. 4E, Six Church Street, New York 6, N. Y., U.S.A. • "TAB"
THAT'S A BUY • CORNER CHURCH & LIBERTY STS., ROOM 200 • THAT'S A BUY

USE STANDARD PARTS — SAVE TIME AND MONEY



K-TRANS

will duplicate the performance of any I. F. Transformer you are using and

COST LESS

Both to buy and to handle in your lines

AUTOMATIC MICA TRIMMERS

are the standard trimmers of the industry



MASS PRODUCTION COILS & MICA TRIMMER CONDENSERS

900 PASSAIC AVE.

EAST NEWARK, N. J.

INDEX TO ADVERTISERS

Acheson Colloids Corporation.....	39	Dazor Mfg. Corp.....	195
Acoustical Mfg. Co., Ltd.....	277	De Mornay Budd, Inc.....	159
Acro Electric Co.....	261	Deutschmann Corporation, Tobe.....	2
Adams & Westlake Company.....	184	Dinion Coil Company, Inc.....	258
Advance Electric & Relay Co.....	240	Drake Electric Works, Inc.....	258
Aermotive Equipment Corp.....	275	Drake Mfg. Co.....	238
Aircraft Radio Corporation.....	66	Driver-Harris Company.....	43
Alden Products Co.....	246	Dumont Electric Corporation.....	12
Allen Mfg. Co.....	238	Dumont Laboratories, Inc., Allen B.....	22, 76
Alliance Manufacturing Co.....	65	du Pont de Nemours and Co. (Inc.) E. I., Plastics Dept.....	73
Allied Radio Corporation.....	261	Eagle Signal Corp.....	279
Allied Recording Products Co.....	273	Eastern Air Devices, Inc.....	23
Alpha Engraving Co.....	281	Eastman Kodak Co., Industrial Photo- graphic Div.....	151
American Brass Co., Waterbury Brass Goods Branch.....	174	Eisler Engineering Co., Inc.....	263, 281
American Electrical Heater Co.....	252	Eitel-McCullough, Inc.....	83
American Lava Corporation.....	35	Electrical Insulation Co., Inc.....	228
American Phenolic Corp.....	8	Electronics Research Publishing Co.....	263
American Precision Dial Co.....	218	Electrons, Inc.....	183
American Rolling Mill Co.....	211	Engineering Co.....	269
American Screw Company.....	32	Erie Resistor Corporation.....	52
American Television & Radio Co.....	262	Essex Electronics.....	292
American Time Products, Inc.....	245	Federal Tel. & Radio Corp.....	54, 153, 269
Amperex Electronic Corporation		Fenwal, Inc.....	197
Inside Front Cover		Formica Insulation Co.....	167
Amperite Company.....	265	Franklin Airloop Corporation.....	49
Anaconda Wire and Cable Co.....	181	Franklin Mfg. Corp., A. W.....	171
Andrew Co.....	210	Freed Transformer Co., Inc.....	273
Ansonia Electrical Div. of Noma Electric Corp.....	14	Fuist Electronics.....	278
Arkwright Finishing Co.....	182	Garrett Co., Inc., George K.....	161
Arnold Engineering Co.....	56	Gear Specialties.....	77
Art Wire & Stamping Co.....	277	General Cement Mfg. Co.....	281
Astatic Corporation.....	172	General Ceramics and Steatite Corp.....	67
Audak Company.....	291	General Electric Co.	
Automatic Mfg. Corporation.....	290	Apparatus Dept.....	7
Avimo, Ltd.....	258	Appliance & Merchandise Dept.....	243
Baer Co., N. S.....	252	Chemical Dept.....	199
Ballantine Laboratories, Inc.....	170	Electronics Department.....	62, 63, 230, 271, 276
Barker & Williamson.....	240	Ken-Rad Div.....	36, 37
Belden Manufacturing Co.....	44	Lamp Dept.....	225
Bell Telephone Laboratories.....	4, 5	General Industries Co.....	234
Bentley, Harris Mfg. Co.....	24	General Magnetic Corporation.....	275
Blan.....	277	General Plate Div. of Metals & Controls Corp.....	221
Blaw-Knox Co.....	219	General Radio Company.....	215
Boonton Radio Corporation.....	11	Goat Co., Inc., Fred, Metal Stampings Div.....	260
Brach Mfg. Co., L. S.....	236	Gramer Co.....	254
Bradley Laboratories, Inc.....	82, 270	Graphite Metallizing Corp.....	230
Brook Electronics, Inc.....	267	Graybar Electric Co.....	228
Brush Development Co.....	64, 208	Guardian Electric Mfg. Co.....	147
Bud Radio, Inc.....	280	Hallicrafters Company.....	71
Burke Electric Co.....	232	Hammarlund Mfg. Co., Inc.....	6
Burlington Instrument Co.....	267	Hardwick, Hindle, Inc.....	271
Burndy Engineering Co., Inc.....	248	Harvey Radio Company.....	234
Burnell & Company.....	263	Harvey Radio Labs., Inc.....	157
Callite Tungsten Corporation.....	68	Hathaway Instrument Co.....	244
Cannon Electric Development Co.....	85	Haydon Manufacturing Co., Inc.....	176
Capitol Radio Engineering Institute.....	270	Heinemann Electric Co.....	177
Carter Motor Co.....	268	Helipot Corporation.....	247
Centralab, Div. of Globe-Union, Inc.....	15, 20, 21	Hewlett-Packard Company.....	81
Chatham Electronics.....	19	Hexacon Electric Co.....	232
Cherry Rivet Co.....	213	Hudson Wire Co.....	261
Chicago Transformer Co.....	69	Hunter Pressed Steel Co.....	41
Cinch Manufacturing Corporation.....	143	Hytron Radio & Electronics Corp.....	51
Clarostat Mfg. Co., Inc.....	266	Imperial Tracing Cloth.....	224
Cleveland Container Co.....	272	Indiana Steel Products Co.....	18
Clippard Instrument Laboratory, Inc.....	281	Industrial Transformer Corp.....	278
Cohn & Co., Sigmund.....	279	Insulation Manufacturers Corp.....	80
Colgate Mfg. Corp.....	185	International Nickel Co., Inc.....	201
Collins Radio Company.....	13	International Resistance Co.....	46, 47
Columbia Wire & Supply Co.....	267	Irvington Varnish & Insulator Co.....	203
Communication Measurements Laboratory.....	198	Jensen Manufacturing Co.....	55
Conant Electrical Labs.....	202	Johnson Co., E. F.....	250
Concord Radio Corporation.....	253	Jones Div., Howard B., Cinch Mfg. Co.....	265
Condenser Products Co.....	223	Kahle Engineering Co.....	281
Continental-Diamond Fibre Co.....	50	Karp Metal Products Co., Inc.....	25
Cornell-Dubilier Electric Corp.....	57	Kenyon Transformer Co., Inc.....	261
Cornish Wire Company, Inc.....	196		
Coto-Coil Co., Inc.....	206		
Cross Co., H.....	281		

*"The Standard
by Which
Others
Are Judged
and Valued"*

AUDAX has mastered wide-range so thoroughly that, today, even the lowest priced MICRODYNE has a range to 7000 cycles—(other models over 10,000 cycles). True, — wide-range makes for naturalness but, —it is highly objectionable if without quality. For example, of two singers, each capable of reaching high C, one may have a pleasing voice—the other, not at all. It is the same with pickups. To achieve EAR-ACCEPTABILITY, all other factors must be satisfied. Of these, VIBRATORY-MOMENTUM is most important. The only way to test EAR-ACCEPTABILITY of a pickup is to put it to the EAR-TEST. The sharp, clean-cut *facsimile* performance of MICRODYNE — regardless of climatic conditions—is a marvel to all who know that EAR-ACCEPTABILITY is the final criterion.

Audax
RELAYED-FLUX
Microdyne
TRADEMARK

Send for complimentary copy of
**"PICK-UP
FACTS"**



AUDAX COMPANY
500 Fifth Avenue,
New York 18

**"Creators of Fine Electronic-Acoustical
Apparatus since 1915"**

ESSEX

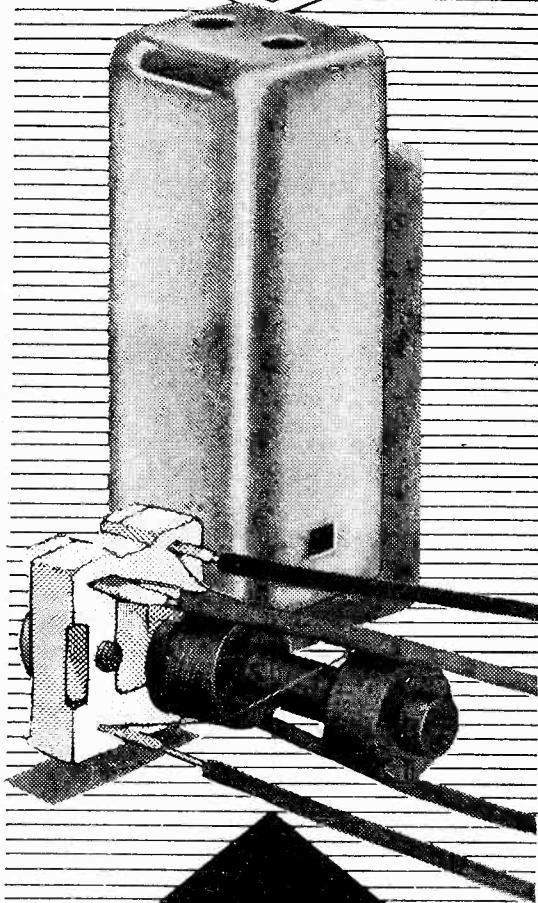

**MIDGET
I.F.
TRANSFORMERS**

for all types of
RADIOS

Performance equivalent
to larger I.F.'s.

$\frac{3}{4}$ " x $\frac{3}{4}$ " x 2" high

We are in full production on
this item. When inquiring,
please designate type of
radio considered.

Orders accepted for
PROMPT DELIVERY

Precision manufacturers of all
types of IF and RF coils,
chokes, and transformers.

**ESSEX
ELECTRONICS**
Berkeley Heights, New Jersey

INDEX TO ADVERTISERS

Kester Solder Co.....	84	Simpson Electric Co.....	227
Keuffel & Esser Co.....	3	Slater Electric and Mfg. Co., Inc.....	275
Kirkland Co., H. R.....	273	Sola Electric Company.....	155
Kurz-Kasch, Inc.....	217	Sorensen & Company, Inc.....	216
Kwikheat Div., Sound Equipment Corp.....	265	Sound Apparatus Co.....	255
Lampkin Laboratories	281	Speer Carbon Co.....	239
Lapp Insulator Co., Inc.....	53	Sprague Electric Co.....	72
Lavoie Laboratories	163	Stackpole Carbon Company.....	179
Macallen Company	214	Standard Pressed Steel Co.....	262
Machlett Laboratories, Inc.....	59	Standard Telephones & Cables, Ltd.....	251
Magnavox Co.	233	Star Expansion Products Co., Inc.....	256
Maguire Industries, Inc.....	27	Stevens-Walden, Inc.....	246
Makepeace Company, D. E.....	235	Steward Mfg. Co., D. M.....	263
Mallory & Co., Inc., P. R.....	86, 145	Struthers-Dunn, Inc.	48
Martin Co., Glenn L.....	222	Stupakoff Ceramic & Mfg. Co.....	74
McGraw-Hill Book Co.....	254, 274	Superior Electric Co.....	209
Measurements Corporation	260	Superior Tube Company.....	237
Mica Insulator Co.....	16, 17	Supreme Instruments Corp.....	282
Miles Reproducer Co., Inc.....	281	Sylvania Electric Products, Inc. Radio Tube Div.	193
Milford River & Machine Co.....	244	Taylor Fibre Co.	277
Millen Mfg. Co., Inc., James.....	224	Tech Laboratories	212
Mitchell-Rand Insulation Co., Inc.....	10	Thomas & Skinner Steel Products Co.....	180
Multi-Products Tool Company.....	40	Tinnerman Products, Inc.....	169
National Carbon Co., Inc.....	191	Topflight Tool Co.....	281
National Company, Inc.....	38	Triplett Electrical Instrument Co.....	242
National Radio Service Co.....	259	Turner Co.	188
National Varnished Products Corporation	231	Union Carbide & Carbon Corp.....	191
New England Screw Co.....	271	United Transformer Corp... Inside Back Cover	
Ohio Electric Mfg. Co.....	186	Universal Winding Co.....	226
Ohmite Mfg. Co.....	32A, 32B	University Loudspeakers, Inc.....	272
Onan & Sons, D. W.....	264	Van Nostrand Co., Inc., D.....	277
O'Neil-Irwin Mfg. Co.....	236	Varflex Corp.	189
Paramount Paper Tube Corp.....	264	Victoreen Instrument Co.....	257
Patton-MacGuyver Co.....	271	Vulcan Electric Co.....	256
Phillips Screw Manufacturers.....	70	Waldes Kohinoor, Inc.....	173
Phosphor Bronze Smelting Co.....	274	Walter Co., S.....	242
Plastic Wire and Cable Corp.....	60, 61	War Assets Administration.....	164, 165
Portable Products Corp., Paul and Beek- man Div.	58	Ward Leonard Electric Co.....	28, 29
Potter Instrument Co.....	33	Weller Mfg. Co.....	269
Premax Products	256	Western Electric Co.....	4, 5, 42, 75, 149, 228
Presto Recording Corp.....	9	Weston Electrical Instrument Corp.....	249
Progressive Mfg. Co.....	265	Whistler & Son, Inc., S. B.....	207
Pyroferric Company	256	White Dental Mfg. Co., S. S.....	220, 273
Quadruga Manufacturing Co.....	273	Whitehead Stamping Co.....	275
Quaker City Gear Works, Inc.....	178	Wiley & Sons, Inc., John.....	266
Radio Corp. of America, Victor Div. 30, 31, 279, Back Cover		Wilson Co., H. A.....	241
Radio Wire Television, Inc.....	258	Wincharger Corp.	269
Railway Express Agency, Air Express Div.	194	Wright and Weaire Ltd.....	200
Rauland Corporation	175	Zophar Mills, Inc.....	254
Raytheon Mfg. Co.....	45		
R. B. M. Div., Essex Wire Corp.....	34	PROFESSIONAL SERVICES	283
Reeves-Hoffman Corp.....	252		
Reeves Soundcraft Corp.....	250	SEARCHLIGHT SECTION	
Remco Electronic, Inc.....	276	<i>(Classified Advertising)</i>	
Revere Copper & Brass, Inc.....	26	BUSINESS OPPORTUNITIES	284, 285
Rex Rheostat Co.....	281	EMPLOYMENT	283, 284, 285
Richardson Company	79	WANTED TO PURCHASE.....	285
Robinson Recording Laboratories.....	268	USED EQUIPMENT	285, 289
Rockbestos Products Corp.....	229	Advance Transformer Co.....	285
Rogan Bros.	282	American Electric Sales Co., Inc.....	285
Rollin Co.	204	Brooks Inc., B. D.....	285
Ruby Chemical Co.....	267	Clark-Reiss Distributors	285
Scientific Electric Div. of "S" Corrugated Quenched Gap Co.....	190	Columbian Rope Co.	285
Scovill Mfg. Co., Waterville Screw Products Div.	166	Communications Equip. Co.	286
Seeburg Corporation, J. P.....	78	Communications Products Co.	285
Segel Co., Henry P.....	275	Electro-Tech. Equip. Co.	288
Selenium Corp. of America.....	187	Electroncraft Inc.	285, 288
Shallcross Mfg. Co.....	192	Maritime Switchboard	286, 287
Sherron Electronics Co.....	205	Niagara Radio Supply Corp.....	285
Shure Brothers, Inc.....	168	Precision Electrical Instrument Co.....	288
Sigma Instruments Inc.	248	Radio Shack Corp., The.....	288
Sillcocks-Miller Co.....	226	Reliance Merchandising Co.	288
		Servo-Tek Products Co.	285
		Tab.	289



LS SERIES

The Ultimate in Quality

UTC Linear Standard Audio Transformers represent the closest approach to the ideal component from the standpoint of uniform frequency response, low wave form distortion, high efficiency, thorough shielding and utmost dependability. Wartime restrictions having been lifted, and UTC production running at full capacity, we now offer these transformers for immediate delivery.



UTC Linear Standard Transformers feature...

- **True Hum Balancing Coil Structure** . . . maximum neutralization of stray fields.
- **Balanced Variable Impedance Line** . . . permits highest fidelity on every tap of a universal unit . . . no line reflections or transverse couplings.
- **Reversible Mounting** . . . permits above chassis or sub-chassis wiring.
- **Alloy Shields** . . . maximum shielding from induction pickup.
- **Multiple Coil, Semi-Toroidal Coil Structure** . . . minimum distributed capacity and leakage reactance.
- **Precision Winding** . . . accuracy of winding .1%, perfect balance of inductance and capacity; exact impedance reflection.
- **Hiper Alloy** . . . a stable, high permeability nickel-iron core material.
- **High Fidelity** . . . UTC Linear Standard Transformers are the only audio units with a guaranteed uniform response of ± 1.5 DB from 20-20,000 cycles.

For Immediate Delivery

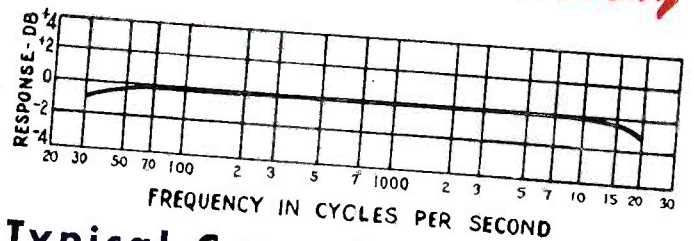

Typical Curve for LS Series

Type No.	Application	Primary Impedance	Secondary Impedance	Max. Level	Relative hum-pickup reduction	Max. unbalanced DC in primary	List Price
LS-10	Low impedance mike, pick-up, or multiple line to grid.	50, 125, 200, 250 333,500 ohms	60,000 ohms in two sections	+15 DB	-74 DB	5 MA	\$25.00
LS-10X	As above	As above	50,000 ohms	+14 DB	-92 DB	5 MA	\$32.00
LS-21	Single plate to push pull grid:	8,000 to 15,000 ohms	135,000 ohms; turn ratio 1.5:1 each side. Split Pri. and Sec.	+14 DB	-74 DB	0 MA	\$24.00
LS-30	Mixing, low impedance mike, pickup, or multiple line to multiple line	50, 125, 200, 250 333, 500 ohms	50, 125, 200, 250, 333, 500 ohms	+17 DB	-74 DB	5 MA	\$25.00
LS-30X	As above	As above	As above	+15 DB	-92 DB	3 MA	\$32.00
LS-50	Single plate to multiple line	8,000 to 15,000 ohms	50, 125, 200, 250, 333, 500 ohms	+17 DB	-74 DB	1 MA	\$24.00
LS-55	Push pull 2A3's, 6A5G's, 300A's, 275A's, 6A3's	5,000 ohms plate to plate and 3,000 ohms plate to plate	500, 333, 250, 200, 125, 50, 30, 20, 15, 10, 7.5, 5, 2.5, 1.2	+36 DB			\$28.00
LS-57	Same as above	5,000 ohms plate to plate and 3,000 ohms plate to plate	30, 20, 15, 10, 7.5, 5, 2.5, 1.2	+36 DB			\$20.00

The above listing includes only a few of the many units of the LS Series. For complete listing — write for catalogue.

United Transformer Corp.

150 VARICK STREET

EXPORT DIVISION: 13 EAST 40th STREET, NEW YORK 16, N. Y.,

NEW YORK 13, N. Y.

CABLES: "ARLAB"

**250
WATTS INPUT*
AT
1200
Mc.**

**...with the new
RCA-5588
grounded-grid
power triode**

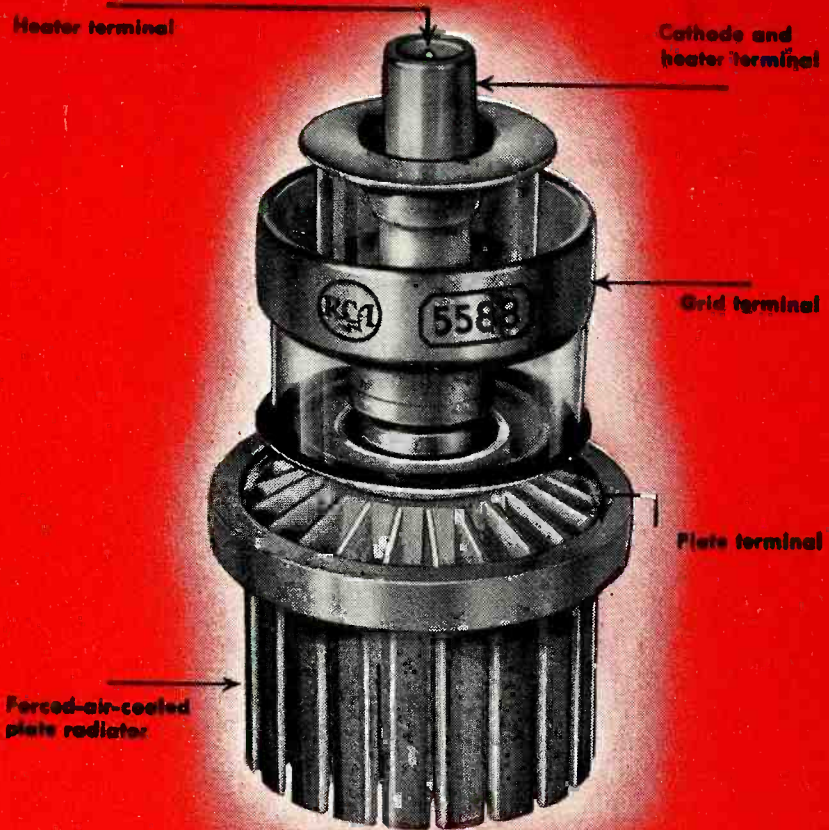

(ACTUAL SIZE)

RATINGS AND CHARACTERISTICS

Amplification factor	23	
Direct interelectrode capacitances:		
Grid-plate	6.5	mmf
Grid-cathode	13	mmf
Plate-cathode	0.32 max.	mmf
Over-all length	3-5/16" ± 3/32"	
Greatest diameter	1.75" ± 0.010"	

As R-F Power Amplifier and Oscillator—
Class C telegraphy, CCS

Key-down conditions per tube
without amplitude modulation

Maximum CCS Ratings, absolute values:

D-C plate voltage	1000 volts
D-C grid voltage	-200 volts
D-C plate current	300 ma.
D-C grid current	100 ma.
Plate input	250 watts
Plate dissipation	200 watts

Here it is . . . a u-h-f tube tiny enough to fit snugly into the palm of your hand, yet big enough to handle a plate dissipation up to 200 watts. It will operate with full plate voltage and plate input at frequencies as high as 1200 Mc . . . and at reduced ratings at higher frequencies.

RCA-5588 is designed with a unique coaxial electrode structure that permits use of a large, heavy-duty cathode to meet the high emission requirements of u-h-f power applications. The tube is particularly well-suited for use in radially spaced, coaxial-cylinder circuits. In these circuits, it can be inserted directly into one end of its circuit cylinder . . . a feature that effectively isolates plate from cathode for optimum grounded-grid service and provides high circuit efficiency for u-h-f service.

Other outstanding features of the 5588 are its large-area, low-inductance electrode terminals . . . silver-plated to reduce r-f losses, its efficient forced-air-cooled plate radiator, and its terminal arrangement that enables you to install the tube quickly without circuit disassembly.

Here is a triode with a power and frequency rating worth considering for those special u-h-f applications. RCA application engineers will be glad to co-operate with you in adapting this or any other RCA tube to meet your equipment needs. For their specialized help, as well as for complete information on the 5588, write RCA, Commercial Engineering, Section R-40D, Harrison, N. J.

*Class C telegraphy, CCS

RCA LABORATORIES
PRINCETON, N. J.

**THE FOUNTAINHEAD OF MODERN
TUBE DEVELOPMENT IS RCA**



TUBE DEPARTMENT

RADIO CORPORATION of AMERICA

HARRISON, N. J.